



Roosevelt Dam in Arizona. Hydrostatic pressure, due to the weight of a standing fluid, can cause enormous forces and moments on large-scale structures such as a dam. Hydrostatic fluid analysis is the subject of the present chapter. (Courtesy of Dr. E.R. Degginger/Color-Pic Inc.)

Chapter 2

Pressure Distribution in a Fluid

Motivation. Many fluid problems do not involve motion. They concern the pressure distribution in a static fluid and its effect on solid surfaces and on floating and submerged bodies.

When the fluid velocity is zero, denoted as the *hydrostatic condition*, the pressure variation is due only to the weight of the fluid. Assuming a known fluid in a given gravity field, the pressure may easily be calculated by integration. Important applications in this chapter are (1) pressure distribution in the atmosphere and the oceans, (2) the design of manometer pressure instruments, (3) forces on submerged flat and curved surfaces, (4) buoyancy on a submerged body, and (5) the behavior of floating bodies. The last two result in Archimedes' principles.

If the fluid is moving in *rigid-body motion*, such as a tank of liquid that has been spinning for a long time, the pressure also can be easily calculated because the fluid is free of shear stress. We apply this idea here to simple rigid-body accelerations in Sec. 2.9. Pressure measurement instruments are discussed in Sec. 2.10. As a matter of fact, pressure also can be analyzed in arbitrary (nonrigid-body) motions $\mathbf{V}(x, y, z, t)$, but we defer that subject to Chap. 4.

2.1 Pressure and Pressure Gradient

In Fig. 1.1 we saw that a fluid at rest cannot support shear stress and thus Mohr's circle reduces to a point. In other words, the normal stress on any plane through a fluid element at rest is a point property called the *fluid pressure* p , taken positive for compression by common convention. This is such an important concept that we shall review it with another approach.

Figure 2.1 shows a small wedge of fluid at rest of size Δx by Δz by Δs and depth b into the paper. There is no shear by definition, but we postulate that the pressures p_x , p_z , and p_n may be different on each face. The weight of the element also may be important. The element is assumed small, so the pressure is constant on each

64 Chapter 2 Pressure Distribution in a Fluid

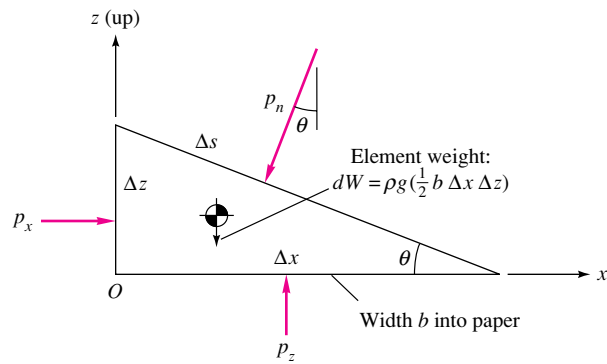

Fig. 2.1 Equilibrium of a small wedge of fluid at rest.

face. Summation of forces must equal zero (no acceleration) in both the x and z directions.

$$\begin{aligned}\sum F_x = 0 &= p_x b \Delta z - p_n b \Delta s \sin \theta \\ \sum F_z = 0 &= p_z b \Delta x - p_n b \Delta s \cos \theta - \frac{1}{2} \rho g b \Delta x \Delta z\end{aligned}\quad (2.1)$$

But the geometry of the wedge is such that

$$\Delta s \sin \theta = \Delta z \quad \Delta s \cos \theta = \Delta x \quad (2.2)$$

Substitution into Eq. (2.1) and rearrangement give

$$p_x = p_n \quad p_z = p_n + \frac{1}{2} \rho g \Delta z \quad (2.3)$$

These relations illustrate two important principles of the hydrostatic, or shear-free, condition: (1) There is no pressure change in the horizontal direction, and (2) there is a vertical change in pressure proportional to the density, gravity, and depth change. We shall exploit these results to the fullest, starting in Sec. 2.3.

In the limit as the fluid wedge shrinks to a “point,” $\Delta z \rightarrow 0$ and Eqs. (2.3) become

$$p_x = p_z = p_n = p \quad (2.4)$$

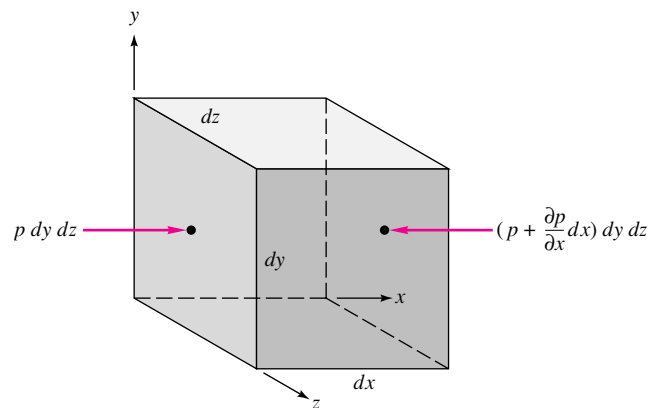

Fig. 2.2 Net x force on an element due to pressure variation.

Since θ is arbitrary, we conclude that the pressure p a static fluid is a point property, independent of orientation.

What about the pressure at a point in a moving fluid? If there are strain rates in a moving fluid, there will be viscous stresses, both shear and normal in general (Sec. 4.3). In that case (Chap. 4) the pressure is defined for incompressible flow as the average of the three normal stresses σ_{ii} on the element

$$p = -\frac{1}{3}(\sigma_{xx} + \sigma_{yy} + \sigma_{zz}) \quad (2.5)$$

The minus sign occurs because a compression stress is considered to be negative whereas p is positive. Equation (2.5) is subtle and rarely needed since the great majority of viscous flows have negligible viscous normal stresses (Chap. 4).

Pressure Force on a Fluid Element

Pressure (or any other stress, for that matter) causes a net force on a fluid element when it varies *spatially*.¹ To see this, consider the pressure acting on the two x faces in Fig. 2.2. Let the pressure vary arbitrarily

$$p = p(x, y, z, t) \quad (2.6)$$

The net force in the x direction on the element in Fig. 2.2 is given by

$$dF_x = p \, dy \, dz - \left(p + \frac{\partial p}{\partial x} dx \right) dy \, dz = -\frac{\partial p}{\partial x} dx \, dy \, dz \quad (2.7)$$

In like manner the net force dF_y involves $-\partial p/\partial y$, and the net force dF_z concerns $-\partial p/\partial z$. The total net-force vector on the element due to pressure is

$$d\mathbf{F}_{\text{press}} = \left(-\mathbf{i} \frac{\partial p}{\partial x} - \mathbf{j} \frac{\partial p}{\partial y} - \mathbf{k} \frac{\partial p}{\partial z} \right) dx \, dy \, dz \quad (2.8)$$

We recognize the term in parentheses as the negative vector gradient of p . Denoting \mathbf{f} as the net force per unit element volume, we rewrite Eq. (2.8) as

$$\mathbf{f}_{\text{press}} = -\nabla p \quad (2.9)$$

Thus it is not the pressure but the pressure *gradient* causing a net force that must be balanced by gravity or acceleration or some other effect in the fluid.

2.2 Equilibrium of a Fluid Element

The pressure gradient is a *surface* force that acts on the sides of the element. There may also be a *body* force, due to electromagnetic or gravitational potentials, acting on the entire mass of the element. Here we consider only the gravity force, or weight of the element:

$$d\mathbf{F}_{\text{grav}} = \rho \mathbf{g} \, dx \, dy \, dz \quad (2.10)$$

or

$$\mathbf{f}_{\text{grav}} = \rho \mathbf{g}$$

In general, there may also be a surface force due to the gradient, if any, of the viscous stresses. For completeness, we write this term here without derivation and

¹An interesting application for a large element is in Fig. 3.7.

consider it more thoroughly in Chap. 4. For an incompressible fluid with constant viscosity, the net viscous force is

$$\mathbf{f}_{\text{vis}} = \mu \left(\frac{\partial^2 \mathbf{V}}{\partial x^2} + \frac{\partial^2 \mathbf{V}}{\partial y^2} + \frac{\partial^2 \mathbf{V}}{\partial z^2} \right) = \mu \nabla^2 \mathbf{V} \quad (2.11)$$

where VS stands for viscous stresses and μ is the coefficient of viscosity from Chap. 1. Note that the term \mathbf{g} in Eq. (2.10) denotes the acceleration of gravity, a vector acting toward the center of the earth. On earth the average magnitude of \mathbf{g} is $32.174 \text{ ft/s}^2 = 9.807 \text{ m/s}^2$.

The total vector resultant of these three forces—pressure, gravity, and viscous stress—must either keep the element in equilibrium or cause it to move with acceleration \mathbf{a} . From Newton's law for constant density and viscosity, Eq. (1.2), we have

$$\rho \mathbf{a} = \sum \mathbf{f} = \mathbf{f}_{\text{press}} + \mathbf{f}_{\text{grav}} + \mathbf{f}_{\text{visc}} = -\nabla p + \rho \mathbf{g} + \mu \nabla^2 \mathbf{V} \quad (2.12)$$

This is one form of the differential momentum equation for a fluid element, and it is studied further in Chap. 4. Vector addition is implied by Eq. (2.12): The acceleration reflects the local balance of forces and is not necessarily parallel to the local-velocity vector, which reflects the direction of motion at that instant.

This chapter is concerned with cases where the velocity and acceleration are known, leaving one to solve for the pressure variation in the fluid. Later chapters will take up the more general problem where pressure, velocity, and acceleration are all unknown. Rewrite Eq. (2.12) as

$$\nabla p = \rho(\mathbf{g} - \mathbf{a}) + \mu \nabla^2 \mathbf{V} = \mathbf{B}(x, y, z, t) \quad (2.13)$$

where \mathbf{B} is a short notation for the vector sum on the right-hand side. If \mathbf{V} and $\mathbf{a} = d\mathbf{V}/dt$ are known functions of space and time and the density and viscosity are known, we can solve Eq. (2.13) for $p(x, y, z, t)$ by direct integration. By components, Eq. (2.13) is equivalent to three simultaneous first-order differential equations

$$\frac{\partial p}{\partial x} = B_x(x, y, z, t) \quad \frac{\partial p}{\partial y} = B_y(x, y, z, t) \quad \frac{\partial p}{\partial z} = B_z(x, y, z, t) \quad (2.14)$$

Since the right-hand sides are known functions, they can be integrated systematically to obtain the distribution $p(x, y, z, t)$ except for an unknown function of time, which remains because we have no relation for $\partial p/\partial t$. This extra function is found from a condition of known time variation $p_0(t)$ at some point (x_0, y_0, z_0) . If the flow is steady (independent of time), the unknown function is a constant and is found from knowledge of a single known pressure p_0 at a point (x_0, y_0, z_0) . If this sounds complicated, it is not; we shall illustrate with many examples.

Examining Eq. (2.13), we can single out at least four special cases:

1. **Flow at rest or at constant velocity:** The acceleration and viscous terms vanish identically, and p depends only on gravity and density. This is the *hydrostatic* condition. See Sec. 2.3.
2. **Rigid-body translation and rotation:** The viscous term vanishes identically, and p depends only on the term $\rho(\mathbf{g} - \mathbf{a})$. See Sec. 2.9.
3. **Irrotational motion ($\nabla \times \mathbf{V} \equiv \mathbf{0}$):** The viscous term vanishes identically, and an exact integral called *Bernoulli's equation* can be found for the pressure distribution. See Sec. 4.9.

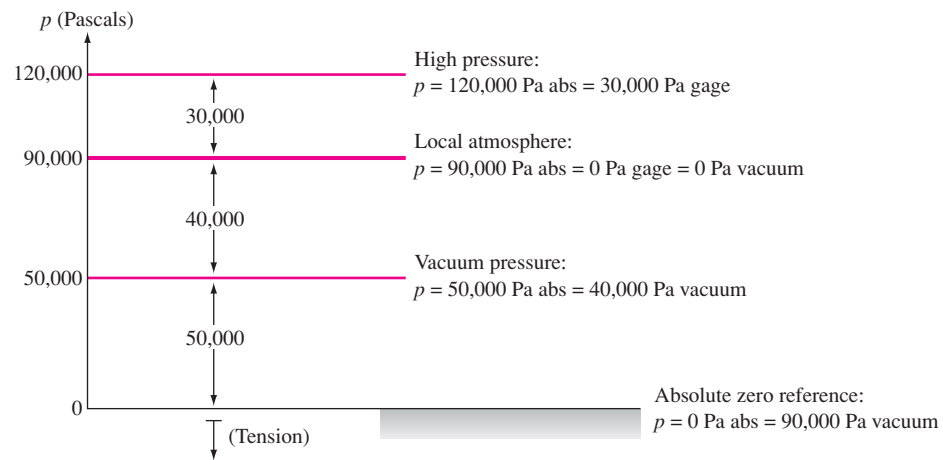

Fig. 2.3 Illustration of absolute, gage, and vacuum pressure readings.

4. **Arbitrary viscous motion:** Nothing helpful happens, no general rules apply, but still the integration is quite straightforward. See Sec. 6.4.

Let us consider cases 1 and 2 here.

Gage Pressure and Vacuum Pressure: Relative Terms

Before embarking on examples, we should note that engineers are apt to specify pressures as (1) the *absolute* or total magnitude or (2) the value *relative* to the local ambient atmosphere. The second case occurs because many pressure instruments are of *differential* type and record, not an absolute magnitude, but the difference between the fluid pressure and the atmosphere. The measured pressure may be either higher or lower than the local atmosphere, and each case is given a name:

1. $p > p_a$ *Gage pressure:* $p(\text{gage}) = p - p_a$
2. $p < p_a$ *Vacuum pressure:* $p(\text{vacuum}) = p_a - p$

This is a convenient shorthand, and one later adds (or subtracts) atmospheric pressure to determine the absolute fluid pressure.

A typical situation is shown in Fig. 2.3. The local atmosphere is at, say, 90,000 Pa, which might reflect a storm condition in a sea-level location or normal conditions at an altitude of 1000 m. Thus, on this day, $p_a = 90,000$ Pa absolute = 0 Pa gage = 0 Pa vacuum. Suppose gage 1 in a laboratory reads $p_1 = 120,000$ Pa absolute. This value may be reported as a *gage* pressure, $p_1 = 120,000 - 90,000 = 30,000$ Pa *gage*. (One must also record the atmospheric pressure in the laboratory, since p_a changes gradually.) Suppose gage 2 reads $p_2 = 50,000$ Pa absolute. Locally, this is a *vacuum* pressure and might be reported as $p_2 = 90,000 - 50,000 = 40,000$ Pa *vacuum*. Occasionally, in the problems section, we will specify gage or vacuum pressure to keep you alert to this common engineering practice. If a pressure is listed without the modifier gage or vacuum, we assume it is absolute pressure.

2.3 Hydrostatic Pressure Distributions

If the fluid is at rest or at constant velocity, $\mathbf{a} = 0$ and $\nabla^2 \mathbf{V} = 0$. Equation (2.13) for the pressure distribution reduces to

$$\nabla p = \rho \mathbf{g} \quad (2.15)$$

This is a *hydrostatic* distribution and is correct for all fluids at rest, regardless of their viscosity, because the viscous term vanishes identically.

Recall from vector analysis that the vector ∇p expresses the magnitude and direction of the maximum spatial rate of increase of the scalar property p . As a result, ∇p is perpendicular everywhere to surfaces of constant p . Thus Eq. (2.15) states that a fluid in hydrostatic equilibrium will align its constant-pressure surfaces everywhere normal to the local-gravity vector. The maximum pressure increase will be in the direction of gravity—that is, “down.” If the fluid is a liquid, its free surface, being at atmospheric pressure, will be normal to local gravity, or “horizontal.” You probably knew all this before, but Eq. (2.15) is the proof of it.

In our customary coordinate system z is “up.” Thus the local-gravity vector for small-scale problems is

$$\mathbf{g} = -g\mathbf{k} \quad (2.16)$$

where g is the magnitude of local gravity, for example, 9.807 m/s^2 . For these coordinates Eq. (2.15) has the components

$$\frac{\partial p}{\partial x} = 0 \quad \frac{\partial p}{\partial y} = 0 \quad \frac{\partial p}{\partial z} = -\rho g = -\gamma \quad (2.17)$$

the first two of which tell us that p is independent of x and y . Hence $\partial p/\partial z$ can be replaced by the total derivative dp/dz , and the hydrostatic condition reduces to

$$\frac{dp}{dz} = -\gamma$$

or

$$p_2 - p_1 = -\int_1^2 \gamma dz \quad (2.18)$$

Equation (2.18) is the solution to the hydrostatic problem. The integration requires an assumption about the density and gravity distribution. Gases and liquids are usually treated differently.

We state the following conclusions about a hydrostatic condition:

Pressure in a continuously distributed uniform static fluid varies only with vertical distance and is independent of the shape of the container. The pressure is the same at all points on a given horizontal plane in the fluid. The pressure increases with depth in the fluid.

An illustration of this is shown in Fig. 2.4. The free surface of the container is atmospheric and forms a horizontal plane. Points a , b , c , and d are at equal depth in a horizontal plane and are interconnected by the same fluid, water; therefore all points have the same pressure. The same is true of points A , B , and C on the bottom, which all have the same higher pressure than at a , b , c , and d . However, point D , although at the same depth as A , B , and C , has a different pressure because it lies beneath a different fluid, mercury.

Effect of Variable Gravity

For a spherical planet of uniform density, the acceleration of gravity varies inversely as the square of the radius from its center

$$g = g_0 \left(\frac{r_0}{r} \right)^2 \quad (2.19)$$

Fig. 2.4 Hydrostatic-pressure distribution. Points a , b , c , and d are at equal depths in water and therefore have identical pressures. Points A , B , and C are also at equal depths in water and have identical pressures higher than a , b , c , and d . Point D has a different pressure from A , B , and C because it is not connected to them by a water path.

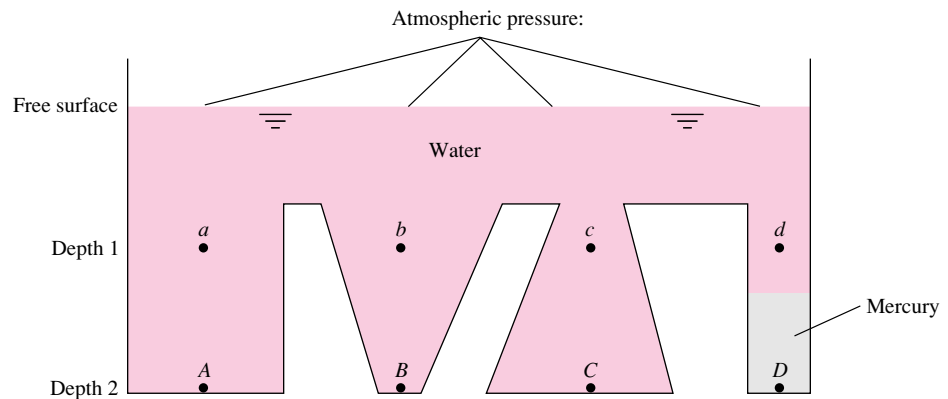

where r_0 is the planet radius and g_0 is the surface value of g . For earth, $r_0 \approx 3960$ statute mi ≈ 6400 km. In typical engineering problems the deviation from r_0 extends from the deepest ocean, about 11 km, to the atmospheric height of supersonic transport operation, about 20 km. This gives a maximum variation in g of $(6400/6420)^2$, or 0.6 percent. We therefore neglect the variation of g in most problems.

Hydrostatic Pressure in Liquids

Liquids are so nearly incompressible that we can neglect their density variation in hydrostatics. In Example 1.7 we saw that water density increases only 4.6 percent at the deepest part of the ocean. Its effect on hydrostatics would be about half of this, or 2.3 percent. Thus we assume constant density in liquid hydrostatic calculations, for which Eq. (2.18) integrates to

$$\text{Liquids:} \quad p_2 - p_1 = -\gamma(z_2 - z_1) \quad (2.20)$$

$$\text{or} \quad z_1 - z_2 = \frac{p_2}{\gamma} - \frac{p_1}{\gamma}$$

We use the first form in most problems. The quantity γ is called the *specific weight* of the fluid, with dimensions of weight per unit volume; some values are tabulated in Table 2.1. The quantity p/γ is a length called the *pressure head* of the fluid.

Table 2.1 Specific Weight of Some Common Fluids

Fluid	Specific weight γ at 68°F = 20°C	
	lbf/ft ³	N/m ³
Air (at 1 atm)	0.0752	11.8
Ethyl alcohol	49.2	7,733
SAE 30 oil	55.5	8,720
Water	62.4	9,790
Seawater	64.0	10,050
Glycerin	78.7	12,360
Carbon tetrachloride	99.1	15,570
Mercury	846	133,100

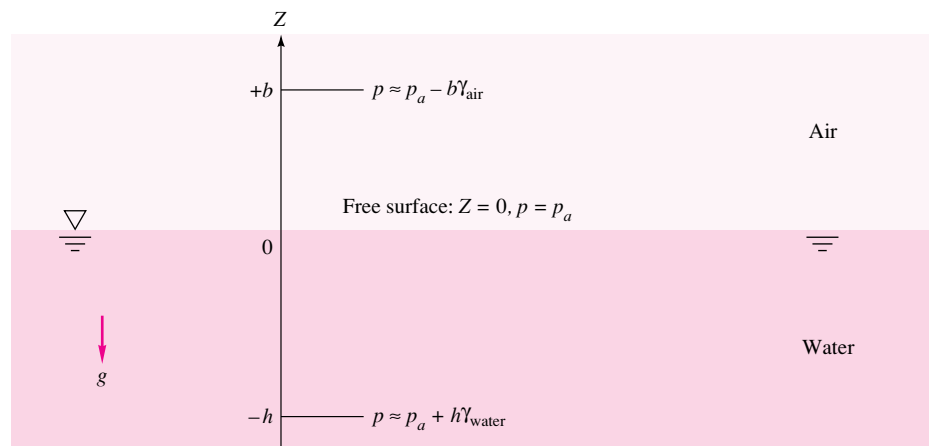

Fig. 2.5 Hydrostatic-pressure distribution in oceans and atmospheres.

For lakes and oceans, the coordinate system is usually chosen as in Fig. 2.5, with $z = 0$ at the free surface, where p equals the surface atmospheric pressure p_a . When we introduce the reference value $(p_1, z_1) = (p_a, 0)$, Eq. (2.20) becomes, for p at any (negative) depth z ,

$$\text{Lakes and oceans:} \quad p = p_a - \gamma z \quad (2.21)$$

where γ is the average specific weight of the lake or ocean. As we shall see, Eq. (2.21) holds in the atmosphere also with an accuracy of 2 percent for heights z up to 1000 m.

EXAMPLE 2.1

Newfound Lake, a freshwater lake near Bristol, New Hampshire, has a maximum depth of 60 m, and the mean atmospheric pressure is 91 kPa. Estimate the absolute pressure in kPa at this maximum depth.

Solution

- *System sketch:* Imagine that Fig. 2.5 is Newfound Lake, with $h = 60$ m and $z = 0$ at the surface.
- *Property values:* From Table 2.1, $\gamma_{\text{water}} = 9790 \text{ N/m}^3$. We are given that $p_{\text{atmos}} = 91 \text{ kPa}$.
- *Solution steps:* Apply Eq. (2.21) to the deepest point. Use SI units, pascals, not kilopascals:

$$p_{\text{max}} = p_a - \gamma z = 91,000 \text{ Pa} - (9790 \frac{\text{N}}{\text{m}^3})(-60 \text{ m}) = 678,400 \text{ Pa} \approx 678 \text{ kPa} \quad \text{Ans.}$$

- *Comments:* Kilopascals are awkward. Use pascals in the formula, then convert the answer.

The Mercury Barometer

The simplest practical application of the hydrostatic formula (2.20) is the barometer (Fig. 2.6), which measures atmospheric pressure. A tube is filled with mercury and inverted while submerged in a reservoir. This causes a near vacuum in the closed upper end because mercury has an extremely small vapor pressure at room temperatures

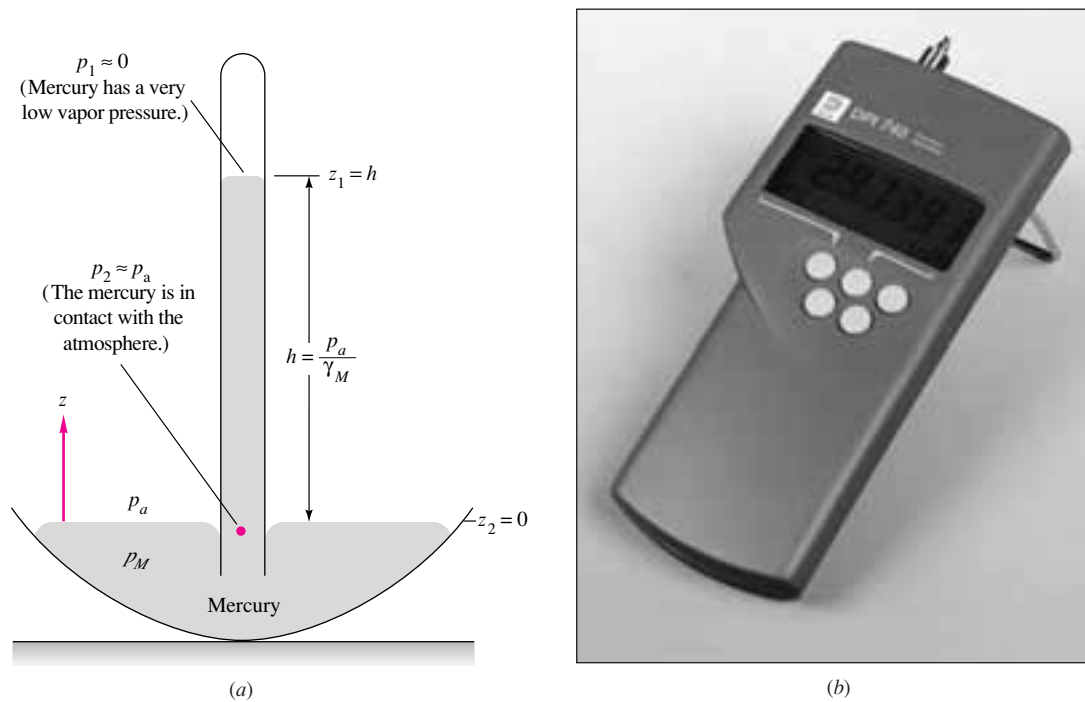

Fig. 2.6 A barometer measures local absolute atmospheric pressure: (a) the height of a mercury column is proportional to p_{atm} ; (b) a modern portable barometer, with digital readout, uses the resonating silicon element of Fig. 2.28c. (Courtesy of Paul Lupke, Druck Inc.)

(0.16 Pa at 20°C). Since atmospheric pressure forces a mercury column to rise a distance h into the tube, the upper mercury surface is at zero pressure.

From Fig. 2.6, Eq. (2.20) applies with $p_1 = 0$ at $z_1 = h$ and $p_2 = p_a$ at $z_2 = 0$:

$$p_a - 0 = -\gamma_M(0 - h)$$

or

$$h = \frac{p_a}{\gamma_M} \quad (2.22)$$

At sea-level standard, with $p_a = 101,350$ Pa and $\gamma_M = 133,100$ N/m³ from Table 2.1, the barometric height is $h = 101,350/133,100 = 0.761$ m or 761 mm. In the United States the weather service reports this as an atmospheric “pressure” of 29.96 inHg (inches of mercury). Mercury is used because it is the heaviest common liquid. A water barometer would be 34 ft high.

Hydrostatic Pressure in Gases

Gases are compressible, with density nearly proportional to pressure. Thus density must be considered as a variable in Eq. (2.18) if the integration carries over large pressure changes. It is sufficiently accurate to introduce the perfect-gas law $p = \rho RT$ in Eq. (2.18):

$$\frac{dp}{dz} = -\rho g = -\frac{p}{RT} g$$

72 Chapter 2 Pressure Distribution in a Fluid

Separate the variables and integrate between points 1 and 2:

$$\int_1^2 \frac{dp}{p} = \ln \frac{p_2}{p_1} = -\frac{g}{R} \int_1^2 \frac{dz}{T} \quad (2.23)$$

The integral over z requires an assumption about the temperature variation $T(z)$. One common approximation is the *isothermal atmosphere*, where $T = T_0$:

$$p_2 = p_1 \exp \left[-\frac{g(z_2 - z_1)}{RT_0} \right] \quad (2.24)$$

The quantity in brackets is dimensionless. (Think that over; it must be dimensionless, right?) Equation (2.24) is a fair approximation for earth, but actually the earth's mean atmospheric temperature drops off nearly linearly with z up to an altitude of about 36,000 ft (11,000 m):

$$T \approx T_0 - Bz \quad (2.25)$$

Here T_0 is sea-level temperature (absolute) and B is the *lapse rate*, both of which vary somewhat from day to day. By international agreement [1] the following standard values are assumed to apply from 0 to 36,000 ft:

$$\begin{aligned} T_0 &= 518.69^\circ\text{R} = 288.16 \text{ K} = 15^\circ\text{C} \\ B &= 0.003566^\circ\text{R}/\text{ft} = 0.00650 \text{ K/m} \end{aligned} \quad (2.26)$$

This lower portion of the atmosphere is called the *troposphere*. Introducing Eq. (2.25) into (2.23) and integrating, we obtain the more accurate relation

$$p = p_a \left(1 - \frac{Bz}{T_0} \right)^{g/(RB)} \quad \text{where } \frac{g}{RB} = 5.26 \text{ (air)} \quad (2.27)$$

in the troposphere, with $z = 0$ at sea level. The exponent $g/(RB)$ is dimensionless (again it must be) and has the standard value of 5.26 for air, with $R = 287 \text{ m}^2/(\text{s}^2 \cdot \text{K})$.

The U.S. standard atmosphere [1] is sketched in Fig. 2.7. The pressure is seen to be nearly zero at $z = 30 \text{ km}$. For tabulated properties see Table A.6.

EXAMPLE 2.2

If sea-level pressure is 101,350 Pa, compute the standard pressure at an altitude of 5000 m, using (a) the exact formula and (b) an isothermal assumption at a standard sea-level temperature of 15°C. Is the isothermal approximation adequate?

Solution

Part (a) Use absolute temperature in the exact formula, Eq. (2.27):

$$\begin{aligned} p &= p_a \left[1 - \frac{(0.00650 \text{ K/m})(5000 \text{ m})}{288.16 \text{ K}} \right]^{5.26} = (101,350 \text{ Pa})(0.8872)^{5.26} \\ &= 101,350(0.5328) = 54,000 \text{ Pa} \end{aligned} \quad \text{Ans. (a)}$$

This is the standard-pressure result given at $z = 5000 \text{ m}$ in Table A.6.

Part (b)

If the atmosphere were isothermal at 288.16 K, Eq. (2.24) would apply:

$$p \approx p_a \exp\left(-\frac{gz}{RT}\right) = (101,350 \text{ Pa}) \exp\left\{-\frac{(9.807 \text{ m/s}^2)(5000 \text{ m})}{[287 \text{ m}^2/(\text{s}^2 \cdot \text{K})](288.16 \text{ K})}\right\}$$

$$= (101,350 \text{ Pa}) \exp(-0.5929) \approx 56,000 \text{ Pa} \quad \text{Ans. (b)}$$

This is 4 percent higher than the exact result. The isothermal formula is inaccurate in the troposphere.

Is the Linear Formula Adequate for Gases?

The linear approximation from Eq. (2.20) or (2.21), $\Delta p \approx \gamma \Delta z$, is satisfactory for liquids, which are nearly incompressible. It may be used even over great depths in the ocean. For gases, which are highly compressible, it is valid only over moderate changes in altitude.

The error involved in using the linear approximation (2.21) can be evaluated by expanding the more accurate formula (2.27) into a series

$$\left(1 - \frac{Bz}{T_0}\right)^n = 1 - n\frac{Bz}{T_0} + \frac{n(n-1)}{2!}\left(\frac{Bz}{T_0}\right)^2 - \dots \quad (2.28)$$

where $n = g/(RB)$. Introducing these first three terms of the series into Eq. (2.27) and rearranging, we obtain

$$p = p_a - \gamma_a z \left(1 - \frac{n-1}{2} \frac{Bz}{T_0} + \dots\right) \quad (2.29)$$

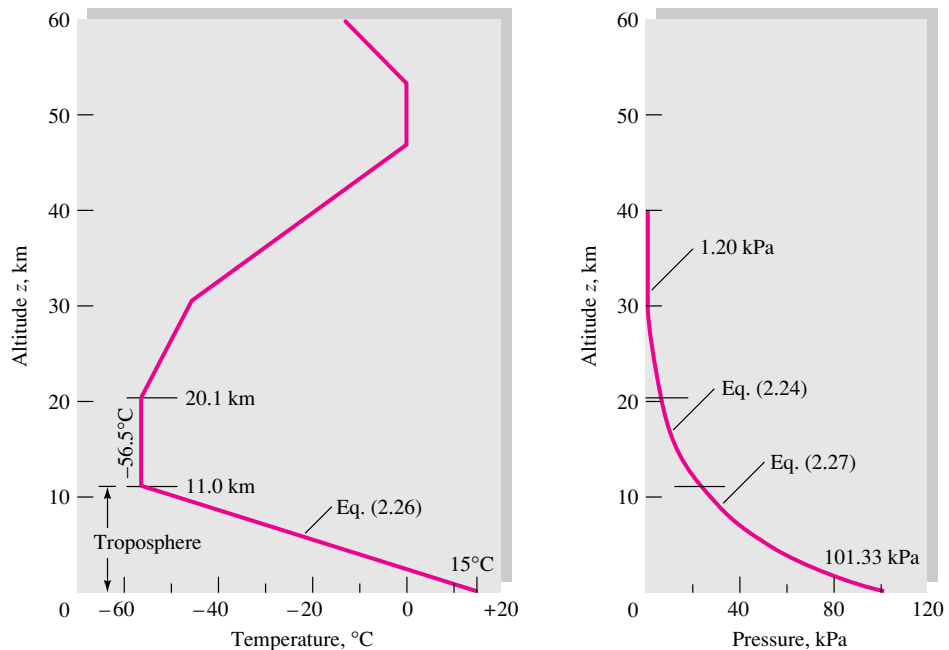

Fig. 2.7 Temperature and pressure distribution in the U.S. standard atmosphere. (From Ref. 1.)

74 Chapter 2 Pressure Distribution in a Fluid

Thus the error in using the linear formula (2.21) is small if the second term in parentheses in (2.29) is small compared with unity. This is true if

$$z \ll \frac{2T_0}{(n-1)B} = 20,800 \text{ m} \quad (2.30)$$

We thus expect errors of less than 5 percent if z or δz is less than 1000 m.

2.4 Application to Manometry

From the hydrostatic formula (2.20), a change in elevation $z_2 - z_1$ of a liquid is equivalent to a change in pressure $(p_2 - p_1)/\gamma$. Thus a static column of one or more liquids or gases can be used to measure pressure differences between two points. Such a device is called a *manometer*. If multiple fluids are used, we must change the density in the formula as we move from one fluid to another. Figure 2.8 illustrates the use of the formula with a column of multiple fluids. The pressure change through each fluid is calculated separately. If we wish to know the total change $p_5 - p_1$, we add the successive changes $p_2 - p_1$, $p_3 - p_2$, $p_4 - p_3$, and $p_5 - p_4$. The intermediate values of p cancel, and we have, for the example of Fig. 2.8,

$$p_5 - p_1 = -\gamma_0(z_2 - z_1) - \gamma_w(z_3 - z_2) - \gamma_G(z_4 - z_3) - \gamma_M(z_5 - z_4) \quad (2.31)$$

No additional simplification is possible on the right-hand side because of the different densities. Notice that we have placed the fluids in order from the lightest on top to the heaviest at bottom. This is the only stable configuration. If we attempt to layer them in any other manner, the fluids will overturn and seek the stable arrangement.

A Memory Device: Up Versus Down

The basic hydrostatic relation, Eq. (2.20), is mathematically correct but vexing to engineers because it combines two negative signs to have the pressure increase downward. When calculating hydrostatic pressure changes, engineers work instinctively by

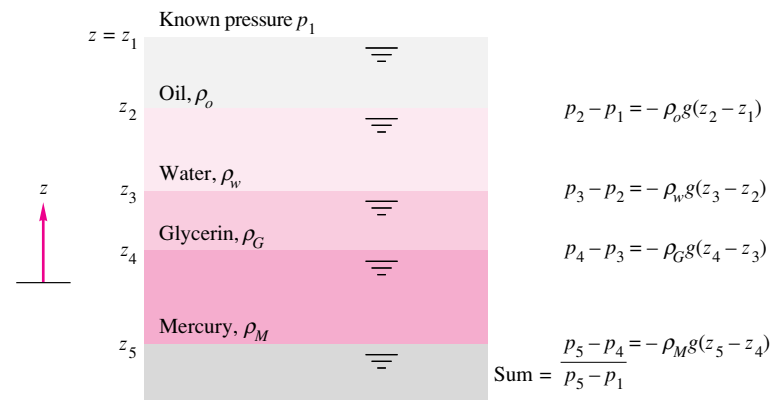

Fig. 2.8 Evaluating pressure changes through a column of multiple fluids.

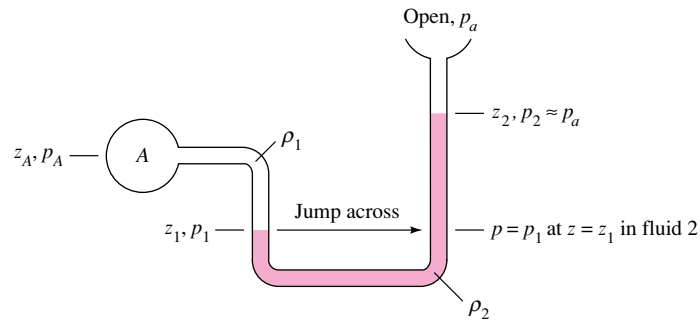

Fig. 2.9 Simple open manometer for measuring p_A relative to atmospheric pressure.

simply having the pressure increase downward and decrease upward. Thus they use the following mnemonic, or memory device, first suggested to the writer by Professor John Foss of Michigan State University:

$$p_{\text{down}} = p^{\text{up}} + \gamma |\Delta z| \quad (2.32)$$

Thus, without worrying too much about which point is “ z_1 ” and which is “ z_2 ,” the formula simply increases or decreases the pressure according to whether one is moving down or up. For example, Eq. (2.31) could be rewritten in the following “multiple increase” mode:

$$p_5 = p_1 + \gamma_0 |z_1 - z_2| + \gamma_w |z_2 - z_3| + \gamma_G |z_3 - z_4| + \gamma_M |z_4 - z_5|$$

That is, keep adding on pressure increments as you move down through the layered fluid. A different application is a manometer, which involves both “up” and “down” calculations.

Figure 2.9 shows a simple open manometer for measuring p_A in a closed chamber relative to atmospheric pressure p_a —in other words, measuring the gage pressure. The chamber fluid ρ_1 is combined with a second fluid ρ_2 , perhaps for two reasons: (1) to protect the environment from a corrosive chamber fluid or (2) because a heavier fluid ρ_2 will keep z_2 small and the open tube can be shorter. One can, of course, apply the basic hydrostatic formula (2.20). Or, more simply, one can begin at A , apply Eq. (2.32) “down” to z_1 , jump across fluid 2 (see Fig. 2.9) to the same pressure p_1 , and then use Eq. (2.32) “up” to level z_2 :

$$p_A + \gamma_1 |z_A - z_1| - \gamma_2 |z_1 - z_2| = p_2 \approx p_{\text{atm}} \quad (2.33)$$

The physical reason that we can “jump across” at section 1 is that a continuous length of the same fluid connects these two equal elevations. The hydrostatic relation (2.20) requires this equality as a form of Pascal’s law:

Any two points at the same elevation in a continuous mass of the same static fluid will be at the same pressure.

This idea of jumping across to equal pressures facilitates multiple-fluid problems.

EXAMPLE 2.3

The classic use of a manometer is when two U-tube legs are of equal length, as in Fig. E2.3, and the measurement involves a pressure difference across two horizontal points. The typical application is to measure pressure change across a flow device, as shown. Derive a formula for the pressure difference $p_a - p_b$ in terms of the system parameters in Fig. E2.3.

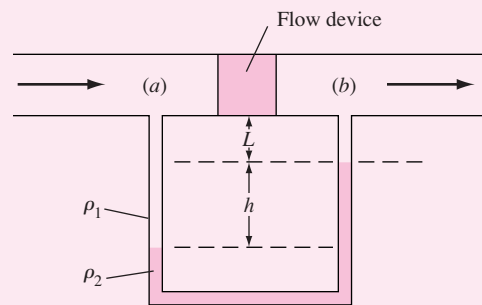
**E2.3****Solution**

Using our “up–down” concept as in Eq. (2.32), start at (a), evaluate pressure changes around the U-tube, and end up at (b):

$$p_a + \rho_1 g L + \rho_1 g h - \rho_2 g h - \rho_1 g L = p_b$$

or

$$p_a - p_b = (\rho_2 - \rho_1) g h \quad \text{Ans.}$$

The measurement only includes h , the manometer reading. Terms involving L drop out. Note the appearance of the *difference* in densities between manometer fluid and working fluid. It is a common student error to fail to subtract out the working fluid density ρ_1 —a serious error if both fluids are liquids and less disastrous numerically if fluid 1 is a gas. Academically, of course, such an error is always considered serious by fluid mechanics instructors.

Although Example 2.3, because of its popularity in engineering experiments, is sometimes considered to be the “manometer formula,” it is best *not* to memorize it but rather to adapt Eq. (2.20) or (2.32) to each new multiple-fluid hydrostatics problem. For example, Fig. 2.10 illustrates a multiple-fluid manometer problem for finding the difference in pressure between two chambers A and B . We repeatedly apply Eq. (2.20), jumping across at equal pressures when we come to a continuous mass of the same fluid. Thus, in Fig. 2.10, we compute four pressure differences while making three jumps:

$$\begin{aligned} p_A - p_B &= (p_A - p_1) + (p_1 - p_2) + (p_2 - p_3) + (p_3 - p_B) \\ &= -\gamma_1(z_A - z_1) - \gamma_2(z_1 - z_2) - \gamma_3(z_2 - z_3) - \gamma_4(z_3 - z_B) \end{aligned} \quad (2.34)$$

The intermediate pressures $p_{1,2,3}$ cancel. It looks complicated, but really it is merely *sequential*. One starts at A , goes down to 1, jumps across, goes up to 2, jumps across, goes down to 3, jumps across, and finally goes up to B .

Fig. 2.10 A complicated multiple-fluid manometer to relate p_A to p_B . This system is not especially practical but makes a good homework or examination problem.

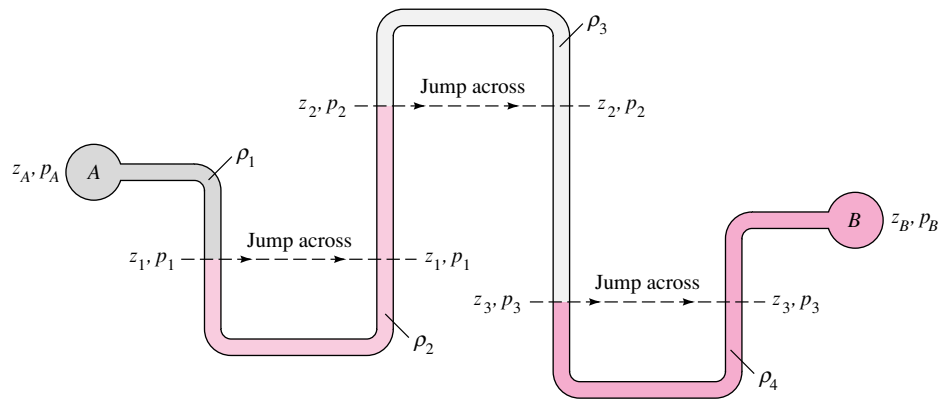

EXAMPLE 2.4

Pressure gage B is to measure the pressure at point A in a water flow. If the pressure at B is 87 kPa, estimate the pressure at A in kPa. Assume all fluids are at 20°C. See Fig. E2.4.

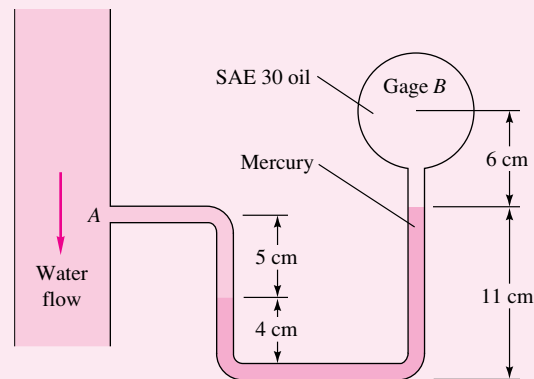

E2.4

Solution

- *System sketch:* The system is shown in Fig. E2.4.
- *Assumptions:* Hydrostatic fluids, no mixing, vertical “up” in Fig. E2.4.
- *Approach:* Sequential use of Eq. (2.32) to go from A to B .
- *Property values:* From Table 2.1 or Table A.3:

$$\gamma_{\text{water}} = 9790 \text{ N/m}^3; \quad \gamma_{\text{mercury}} = 133,100 \text{ N/m}^3; \quad \gamma_{\text{oil}} = 8720 \text{ N/m}^3$$

- *Solution steps:* Proceed from A to B , “down” then “up,” jumping across at the left mercury meniscus:

$$p_A + \gamma_w |\Delta z|_w - \gamma_m |\Delta z|_m - \gamma_o |\Delta z|_o = p_B$$

$$\text{or } p_A + (9790 \text{ N/m}^3)(0.05 \text{ m}) - (133,100 \text{ N/m}^3)(0.07 \text{ m}) - (8720 \text{ N/m}^3)(0.06 \text{ m}) = 87,000$$

$$\text{or } p_A + 490 - 9317 - 523 = 87,000 \quad \text{Solve for } p_A = 96,350 \text{ N/m}^2 \approx 96.4 \text{ kPa} \quad \text{Ans.}$$

- *Comments:* Note that we abbreviated the units N/m^2 to pascals, or Pa. The intermediate five-figure result, $p_A = 96,350$ Pa, is unrealistic, since the data are known to only about three significant figures.

In making these manometer calculations we have neglected the capillary height changes due to surface tension, which were discussed in Example 1.9. These effects cancel if there is a fluid interface, or *meniscus*, between similar fluids on both sides of the U-tube. Otherwise, as in the right-hand U-tube of Fig. 2.10, a capillary correction can be made or the effect can be made negligible by using large-bore (≥ 1 cm) tubes.

2.5 Hydrostatic Forces on Plane Surfaces

The design of containment structures requires computation of the hydrostatic forces on various solid surfaces adjacent to the fluid. These forces relate to the weight of fluid bearing on the surface. For example, a container with a flat, horizontal bottom of area A_b and water depth H will experience a downward bottom force $F_b = \gamma H A_b$. If the surface is not horizontal, additional computations are needed to find the horizontal components of the hydrostatic force.

If we neglect density changes in the fluid, Eq. (2.20) applies and the pressure on any submerged surface varies linearly with depth. For a plane surface, the linear stress distribution is exactly analogous to combined bending and compression of a beam in strength-of-materials theory. The hydrostatic problem thus reduces to simple formulas involving the centroid and moments of inertia of the plate cross-sectional area.

Figure 2.11 shows a plane panel of arbitrary shape completely submerged in a liquid. The panel plane makes an arbitrary angle θ with the horizontal free surface, so that the depth varies over the panel surface. If h is the depth to any element area dA of the plate, from Eq. (2.20) the pressure there is $p = p_a + \gamma h$.

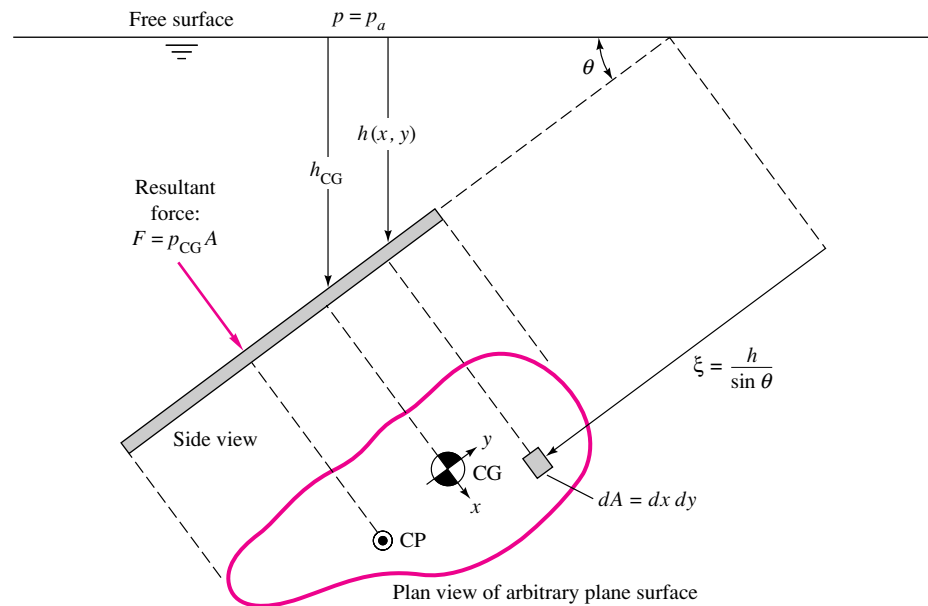

2.11 Hydrostatic force and center of pressure on an arbitrary plane surface of area A inclined at an angle θ below the free surface.

To derive formulas involving the plate shape, establish an xy coordinate system in the plane of the plate with the origin at its centroid, plus a dummy coordinate ξ down from the surface in the plane of the plate. Then the total hydrostatic force on one side of the plate is given by

$$F = \int p \, dA = \int (p_a + \gamma h) \, dA = p_a A + \gamma \int h \, dA \quad (2.35)$$

The remaining integral is evaluated by noticing from Fig. 2.11 that $h = \xi \sin \theta$ and, by definition, the centroidal slant distance from the surface to the plate is

$$\xi_{CG} = \frac{1}{A} \int \xi \, dA \quad (2.36)$$

Therefore, since θ is constant along the plate, Eq. (2.35) becomes

$$F = p_a A + \gamma \sin \theta \int \xi \, dA = p_a A + \gamma \sin \theta \xi_{CG} A \quad (2.37)$$

Finally, unravel this by noticing that $\xi_{CG} \sin \theta = h_{CG}$, the depth straight down from the surface to the plate centroid. Thus

$$F = p_a A + \gamma h_{CG} A = (p_a + \gamma h_{CG}) A = p_{CG} A \quad (2.38)$$

The force on one side of any plane submerged surface in a uniform fluid equals the pressure at the plate centroid times the plate area, independent of the shape of the plate or the angle θ at which it is slanted.

Equation (2.38) can be visualized physically in Fig. 2.12 as the resultant of a linear stress distribution over the plate area. This simulates combined compression and bending of a beam of the same cross section. It follows that the “bending” portion of the stress causes no force if its “neutral axis” passes through the plate centroid of area. Thus the remaining “compression” part must equal the centroid stress times the plate area. This is the result of Eq. (2.38).

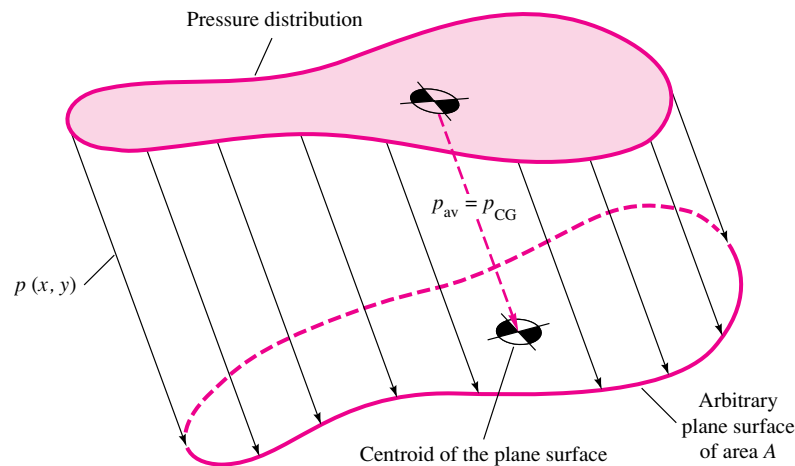

Fig. 2.12 The hydrostatic pressure force on a plane surface is equal, regardless of its shape, to the resultant of the three-dimensional linear pressure distribution on that surface $F = p_{CG} A$.

However, to balance the bending-moment portion of the stress, the resultant force F acts not through the centroid but below it toward the high-pressure side. Its line of action passes through the *center of pressure* CP of the plate, as sketched in Fig. 2.11. To find the coordinates $(x_{\text{CP}}, y_{\text{CP}})$, we sum moments of the elemental force $p \, dA$ about the centroid and equate to the moment of the resultant F . To compute y_{CP} , we equate

$$Fy_{\text{CP}} = \int yp \, dA = \int y(p_a + \gamma\xi \sin \theta) \, dA = \gamma \sin \theta \int y\xi \, dA \quad (2.39)$$

The term $\int p_a y \, dA$ vanishes by definition of centroidal axes. Introducing $\xi = \xi_{\text{CG}} - y$, we obtain

$$Fy_{\text{CP}} = \gamma \sin \theta \left(\xi_{\text{CG}} \int y \, dA - \int y^2 \, dA \right) = -\gamma \sin \theta I_{xx} \quad (2.40)$$

where again $\int y \, dA = 0$ and I_{xx} is the area moment of inertia of the plate area about its centroidal x axis, computed in the plane of the plate. Substituting for F gives the result

$$y_{\text{CP}} = -\gamma \sin \theta \frac{I_{xx}}{\rho_{\text{CG}} A} \quad (2.41)$$

The negative sign in Eq. (2.41) shows that y_{CP} is below the centroid at a deeper level and, unlike F , depends on angle θ . If we move the plate deeper, y_{CP} approaches the centroid because every term in Eq. (2.41) remains constant except ρ_{CG} , which increases.

The determination of x_{CP} is exactly similar:

$$\begin{aligned} Fx_{\text{CP}} &= \int xp \, dA = \int x[p_a + \gamma(\xi_{\text{CG}} - y) \sin \theta] \, dA \\ &= -\gamma \sin \theta \int xy \, dA = -\gamma \sin \theta I_{xy} \end{aligned} \quad (2.42)$$

where I_{xy} is the product of inertia of the plate, again computed in the plane of the plate. Substituting for F gives

$$x_{\text{CP}} = -\gamma \sin \theta \frac{I_{xy}}{\rho_{\text{CG}} A} \quad (2.43)$$

For positive I_{xy} , x_{CP} is negative because the dominant pressure force acts in the third, or lower left, quadrant of the panel. If $I_{xy} = 0$, usually implying symmetry, $x_{\text{CP}} = 0$ and the center of pressure lies directly below the centroid on the y axis.

Gage Pressure Formulas

In most cases the ambient pressure p_a is neglected because it acts on both sides of the plate; for example, the other side of the plate is inside a ship or on the dry side of a gate or dam. In this case $\rho_{\text{CG}} = \gamma h_{\text{CG}}$, and the center of pressure becomes independent of specific weight:

$$F = \gamma h_{\text{CG}} A \quad y_{\text{CP}} = -\frac{I_{xx} \sin \theta}{h_{\text{CG}} A} \quad x_{\text{CP}} = -\frac{I_{xy} \sin \theta}{h_{\text{CG}} A} \quad (2.44)$$

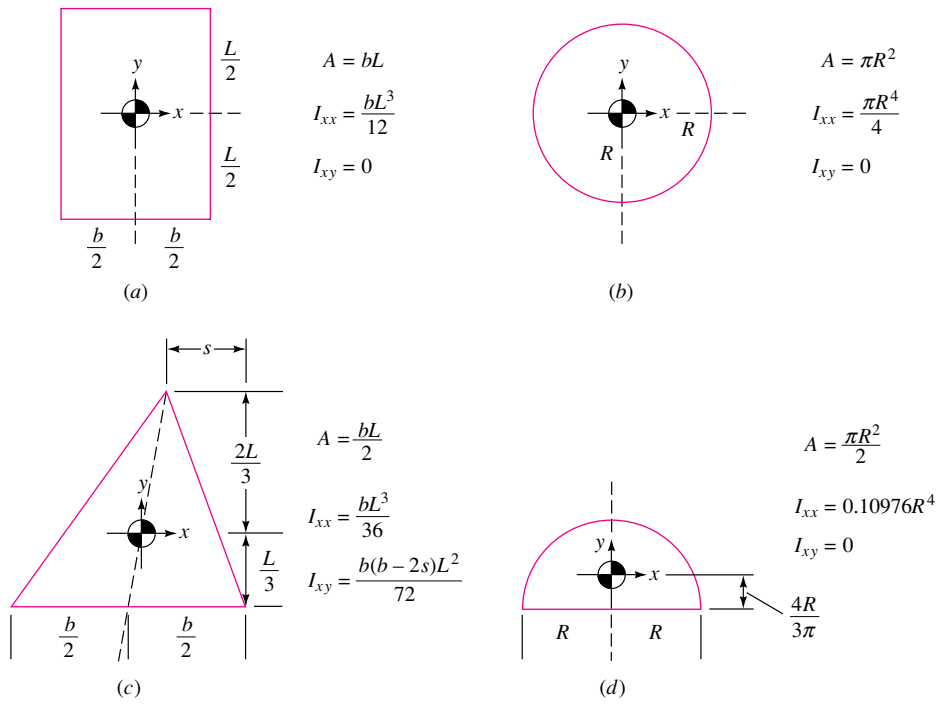
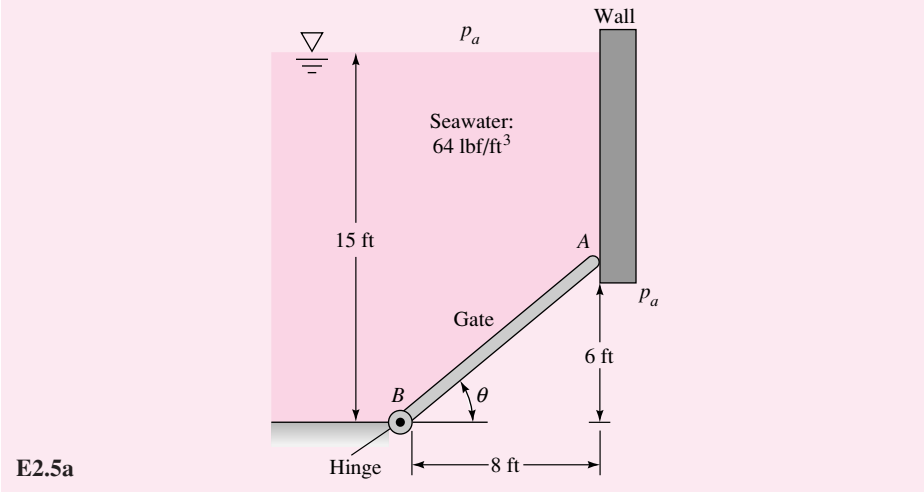

Fig. 2.13 Centroidal moments of inertia for various cross sections: (a) rectangle, (b) circle, (c) triangle, and (d) semicircle.

Figure 2.13 gives the area and moments of inertia of several common cross sections for use with these formulas. Note that θ is the angle between the plate and the horizon.

EXAMPLE 2.5

The gate in Fig. E2.5a is 5 ft wide, is hinged at point B, and rests against a smooth wall at point A. Compute (a) the force on the gate due to seawater pressure, (b) the horizontal force P exerted by the wall at point A, and (c) the reactions at the hinge B.



E2.5a

82 Chapter 2 Pressure Distribution in a Fluid

Solution

Part (a) By geometry the gate is 10 ft long from A to B , and its centroid is halfway between, or at elevation 3 ft above point B . The depth h_{CG} is thus $15 - 3 = 12$ ft. The gate area is $5(10) = 50$ ft². Neglect p_a as acting on both sides of the gate. From Eq. (2.38) the hydrostatic force on the gate is

$$F = p_{CG}A = \gamma h_{CG}A = (64 \text{ lbf/ft}^3)(12 \text{ ft})(50 \text{ ft}^2) = 38,400 \text{ lbf} \quad \text{Ans. (a)}$$

Part (b) First we must find the center of pressure of F . A free-body diagram of the gate is shown in Fig. E2.5b. The gate is a rectangle, hence

$$I_{xy} = 0 \quad \text{and} \quad I_{xx} = \frac{bL^3}{12} = \frac{(5 \text{ ft})(10 \text{ ft})^3}{12} = 417 \text{ ft}^4$$

The distance l from the CG to the CP is given by Eq. (2.44) since p_a is neglected.

$$l = -y_{CP} = + \frac{I_{xx} \sin \theta}{h_{CG}A} = \frac{(417 \text{ ft}^4)(\frac{6}{10})}{(12 \text{ ft})(50 \text{ ft}^2)} = 0.417 \text{ ft}$$

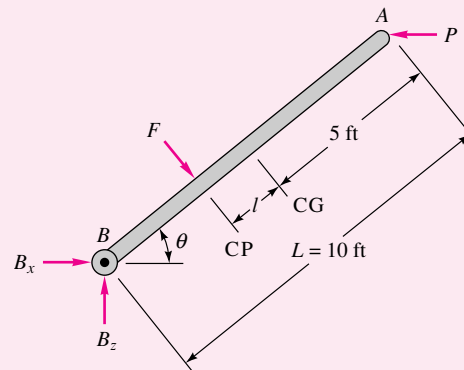
**E2.5b**

The distance from point B to force F is thus $10 - l - 5 = 4.583$ ft. Summing moments counterclockwise about B gives

$$PL \sin \theta - F(5 - l) = P(6 \text{ ft}) - (38,400 \text{ lbf})(4.583 \text{ ft}) = 0$$

or $P = 29,300$ lbf Ans. (b)

Part (c) With F and P known, the reactions B_x and B_z are found by summing forces on the gate:

$$\sum F_x = 0 = B_x + F \sin \theta - P = B_x + 38,400 \text{ lbf} (0.6) - 29,300 \text{ lbf}$$

or $B_x = 6300$ lbf

$$\sum F_z = 0 = B_z - F \cos \theta = B_z - 38,400 \text{ lbf} (0.8)$$

or $B_z = 30,700$ lbf Ans. (c)

This example should have reviewed your knowledge of statics.

EXAMPLE 2.6

A tank of oil has a right-triangular panel near the bottom, as in Fig. E2.6. Omitting p_a , find the (a) hydrostatic force and (b) CP on the panel.

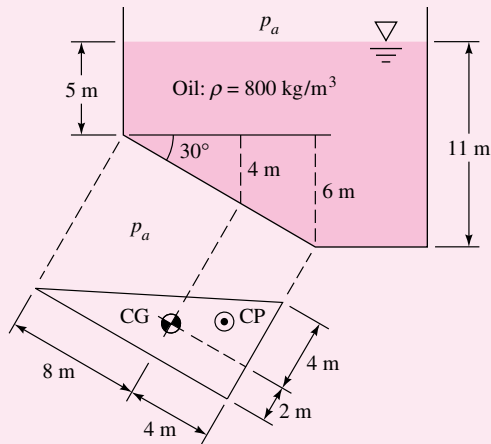
**E2.6****Solution****Part (a)**

The triangle has properties given in Fig. 2.13c. The centroid is one-third up (4 m) and one-third over (2 m) from the lower left corner, as shown. The area is

$$\frac{1}{2}(6 \text{ m})(12 \text{ m}) = 36 \text{ m}^2$$

The moments of inertia are

$$I_{xx} = \frac{bL^3}{36} = \frac{(6 \text{ m})(12 \text{ m})^3}{36} = 288 \text{ m}^4$$

and
$$I_{yy} = \frac{b(b-2s)L^2}{72} = \frac{(6 \text{ m})[6 \text{ m} - 2(6 \text{ m})](12 \text{ m})^2}{72} = -72 \text{ m}^4$$

The depth to the centroid is $h_{CG} = 5 + 4 = 9 \text{ m}$; thus the hydrostatic force from Eq. (2.44) is

$$\begin{aligned} F &= \rho g h_{CG} A = (800 \text{ kg/m}^3)(9.807 \text{ m/s}^2)(9 \text{ m})(36 \text{ m}^2) \\ &= 2.54 \times 10^6 \text{ (kg} \cdot \text{m)/s}^2 = 2.54 \times 10^6 \text{ N} = 2.54 \text{ MN} \end{aligned} \quad \text{Ans. (a)}$$

Part (b)

The CP position is given by Eqs. (2.44):

$$\begin{aligned} y_{CP} &= -\frac{I_{xx} \sin \theta}{h_{CG} A} = -\frac{(288 \text{ m}^4)(\sin 30^\circ)}{(9 \text{ m})(36 \text{ m}^2)} = -0.444 \text{ m} \\ x_{CP} &= -\frac{I_{yy} \sin \theta}{h_{CG} A} = -\frac{(-72 \text{ m}^4)(\sin 30^\circ)}{(9 \text{ m})(36 \text{ m}^2)} = +0.111 \text{ m} \end{aligned} \quad \text{Ans. (b)}$$

The resultant force $F = 2.54 \text{ MN}$ acts through this point, which is down and to the right of the centroid, as shown in Fig. E2.6.

2.6 Hydrostatic Forces on Curved Surfaces

The resultant pressure force on a curved surface is most easily computed by separating it into horizontal and vertical components. Consider the arbitrary curved surface sketched in Fig. 2.14*a*. The incremental pressure forces, being normal to the local area element, vary in direction along the surface and thus cannot be added numerically. We could sum the separate three components of these elemental pressure forces, but it turns out that we need not perform a laborious three-way integration.

Figure 2.14*b* shows a free-body diagram of the column of fluid contained in the vertical projection above the curved surface. The desired forces F_H and F_V are exerted by the surface on the fluid column. Other forces are shown due to fluid weight and horizontal pressure on the vertical sides of this column. The column of fluid must be in static equilibrium. On the upper part of the column $bcde$, the horizontal components F_1 exactly balance and are not relevant to the discussion. On the lower, irregular portion of fluid abc adjoining the surface, summation of horizontal forces shows that the desired force F_H due to the curved surface is exactly equal to the force F_H on the vertical left side of the fluid column. This left-side force can be computed by the plane surface formula, Eq. (2.38), based on a vertical projection of the area of the curved surface. This is a general rule and simplifies the analysis:

The horizontal component of force on a curved surface equals the force on the plane area formed by the projection of the curved surface onto a vertical plane normal to the component.

If there are two horizontal components, both can be computed by this scheme. Summation of vertical forces on the fluid free body then shows that

$$F_V = W_1 + W_2 + W_{air} \quad (2.45)$$

We can state this in words as our second general rule:

The vertical component of pressure force on a curved surface equals in magnitude and direction the weight of the entire column of fluid, both liquid and atmosphere, above the curved surface.

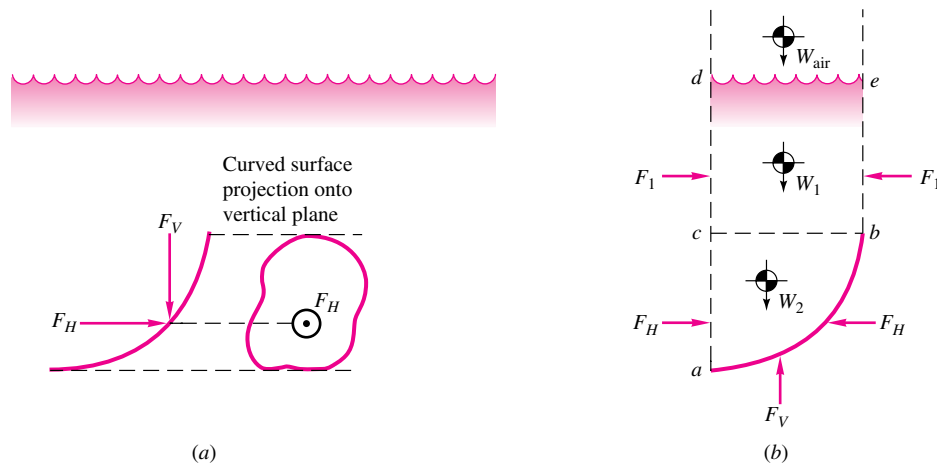
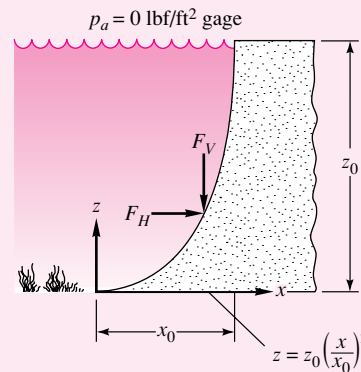

Fig. 2.14 Computation of hydrostatic force on a curved surface: (a) submerged curved surface; (b) free-body diagram of fluid above the curved surface.

Thus the calculation of F_V involves little more than finding centers of mass of a column of fluid—perhaps a little integration if the lower portion abc in Fig. 2.14b has a particularly vexing shape.

EXAMPLE 2.7

A dam has a parabolic shape $z/z_0 = (x/x_0)^2$ as shown in Fig. E2.7a, with $x_0 = 10$ ft and $z_0 = 24$ ft. The fluid is water, $\gamma = 62.4$ lbf/ft³, and atmospheric pressure may be omitted. Compute the forces F_H and F_V on the dam and their line of action. The width of the dam is 50 ft.



E2.7a

Solution

- *System sketch:* Figure E2.7b shows the various dimensions. The dam width is $b = 50$ ft.
- *Approach:* Calculate F_H and its line of action from Eqs. (2.38) and (2.44). Calculate F_V and its line of action by finding the weight of fluid above the parabola and the centroid of this weight.
- *Solution steps for the horizontal component:* The vertical projection of the parabola lies along the z axis in Fig. E2.7b and is a rectangle 24 ft high and 50 ft wide. Its centroid is halfway down, or $h_{CG} = 24/2 = 12$ ft. Its area is $A_{proj} = (24 \text{ ft})(50 \text{ ft}) = 1200 \text{ ft}^2$. Then, from Eq. (2.38),

$$F_H = \gamma h_{CG} A_{proj} = \left(62.4 \frac{\text{lbf}}{\text{ft}^3}\right)(12 \text{ ft})(1200 \text{ ft}^2) = 898,560 \text{ lbf} \approx 899 \times 10^3 \text{ lbf}$$

The line of action of F_H is below the centroid of A_{proj} , as given by Eq. (2.44):

$$y_{CP, \text{proj}} = -\frac{I_{xx} \sin \theta}{h_{CG} A_{proj}} = -\frac{(1/12)(50 \text{ ft})(24 \text{ ft})^3 \sin 90^\circ}{(12 \text{ ft})(1200 \text{ ft}^2)} = -4 \text{ ft}$$

Thus F_H is $12 + 4 = 16$ ft, or two-thirds of the way down from the surface (8 ft up from the bottom).

- *Comments:* Note that you calculate F_H and its line of action from the *vertical projection* of the parabola, not from the parabola itself. Since this projection is *vertical*, its angle $\theta = 90^\circ$.
- *Solution steps for the vertical component:* The vertical force F_V equals the weight of water above the parabola. Alas, a parabolic section is not in Fig. 2.13, so we had to look

86 Chapter 2 Pressure Distribution in a Fluid

it up in another book. The area and centroid are shown in Fig. E2.7b. The weight of this parabolic amount of water is

$$F_V = \gamma A_{\text{section}} b = \left(62.4 \frac{\text{lbf}}{\text{ft}^3}\right) \left[\frac{2}{3} (24 \text{ ft})(10 \text{ ft})\right] (50 \text{ ft}) = 499,200 \text{ lbf} \approx 499 \times 10^3 \text{ lbf}$$

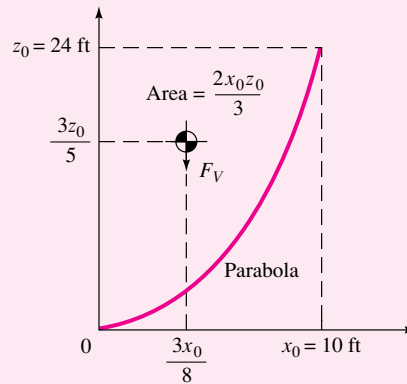

E2.7b

This force acts downward, through the centroid of the parabolic section, or at a distance $3x_0/8 = 3.75 \text{ ft}$ over from the origin, as shown in Figs. E2.7b,c. The resultant hydrostatic force on the dam is

$$F = (F_H^2 + F_V^2)^{1/2} = [(899 \text{E}3 \text{ lbf})^2 + (499 \text{E}3 \text{ lbf})^2]^{1/2} = 1028 \times 10^3 \text{ lbf at } 29^\circ \text{ Ans.}$$

This resultant is shown in Fig. E2.7c and passes through a point 8 ft up and 3.75 ft over from the origin. It strikes the dam at a point 5.43 ft over and 7.07 ft up, as shown.

- *Comments:* Note that entirely different formulas are used to calculate F_H and F_V . The concept of center of pressure CP is, in the writer's opinion, stretched too far when applied to curved surfaces.

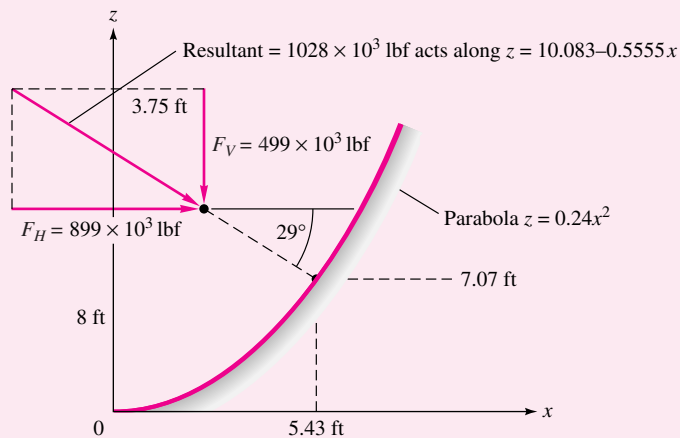

E2.7c

2.7 Hydrostatic Forces in Layered Fluids

The formulas for plane and curved surfaces in Secs. 2.5 and 2.6 are valid only for a fluid of uniform density. If the fluid is layered with different densities, as in Fig. 2.15, a single formula cannot solve the problem because the slope of the linear pressure distribution

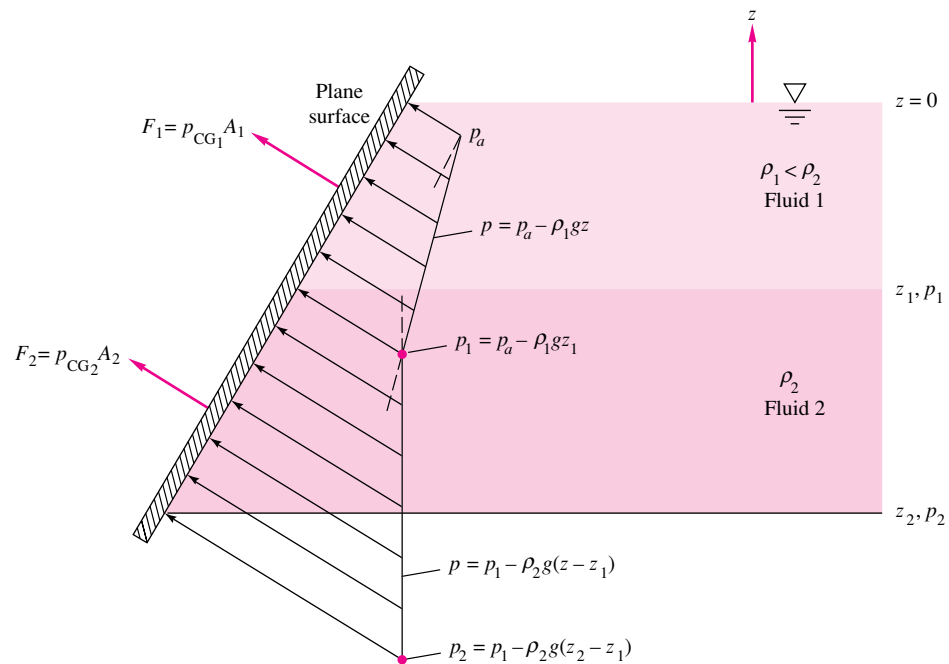

Fig. 2.15 Hydrostatic forces on a surface immersed in a layered fluid must be summed in separate pieces.

changes between layers. However, the formulas apply separately to each layer, and thus the appropriate remedy is to compute and sum the separate layer forces and moments.

Consider the slanted plane surface immersed in a two-layer fluid in Fig. 2.15. The slope of the pressure distribution becomes steeper as we move down into the denser second layer. The total force on the plate does *not* equal the pressure at the centroid times the plate area, but the plate portion in each layer does satisfy the formula, so that we can sum forces to find the total:

$$F = \sum F_i = \sum p_{CG_i} A_i \quad (2.46)$$

Similarly, the centroid of the plate portion in each layer can be used to locate the center of pressure on that portion:

$$y_{CP_i} = -\frac{\rho_i g \sin \theta_i I_{xx_i}}{p_{CG_i} A_i} \quad x_{CP_i} = -\frac{\rho_i g \sin \theta_i I_{xy_i}}{p_{CG_i} A_i} \quad (2.47)$$

These formulas locate the center of pressure of that particular F_i with respect to the centroid of that particular portion of plate in the layer, not with respect to the centroid of the entire plate. The center of pressure of the total force $F = \sum F_i$ can then be found by summing moments about some convenient point such as the surface. The following example will illustrate.

EXAMPLE 2.8

A tank 20 ft deep and 7 ft wide is layered with 8 ft of oil, 6 ft of water, and 4 ft of mercury. Compute (a) the total hydrostatic force and (b) the resultant center of pressure of the fluid on the right-hand side of the tank.

Solution

Part (a) Divide the end panel into three parts as sketched in Fig. E2.8, and find the hydrostatic pressure at the centroid of each part, using the relation (2.38) in steps as in Fig. E2.8:

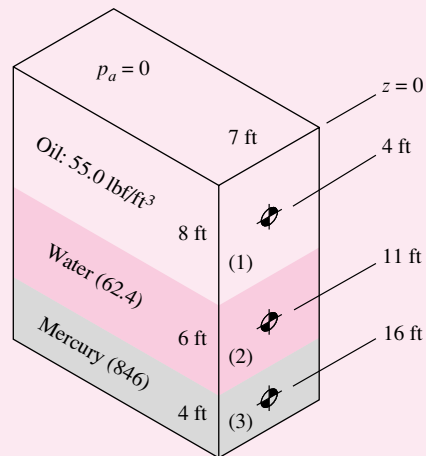
**E2.8**

$$p_{CG_1} = (55.0 \text{ lbf/ft}^3)(4 \text{ ft}) = 220 \text{ lbf/ft}^2$$

$$p_{CG_2} = (55.0)(8) + 62.4(3) = 627 \text{ lbf/ft}^2$$

$$p_{CG_3} = (55.0)(8) + 62.4(6) + 846(2) = 2506 \text{ lbf/ft}^2$$

These pressures are then multiplied by the respective panel areas to find the force on each portion:

$$F_1 = p_{CG_1}A_1 = (220 \text{ lbf/ft}^2)(8 \text{ ft})(7 \text{ ft}) = 12,300 \text{ lbf}$$

$$F_2 = p_{CG_2}A_2 = 627(6)(7) = 26,300 \text{ lbf}$$

$$F_3 = p_{CG_3}A_3 = 2506(4)(7) = \underline{70,200 \text{ lbf}}$$

$$F = \sum F_i = 108,800 \text{ lbf} \quad \text{Ans. (a)}$$

Part (b) Equations (2.47) can be used to locate the CP of each force F_i , noting that $\theta = 90^\circ$ and $\sin \theta = 1$ for all parts. The moments of inertia are $I_{xx_1} = (7 \text{ ft})(8 \text{ ft})^3/12 = 298.7 \text{ ft}^4$, $I_{xx_2} = 7(6)^3/12 = 126.0 \text{ ft}^4$, and $I_{xx_3} = 7(4)^3/12 = 37.3 \text{ ft}^4$. The centers of pressure are thus at

$$y_{CP_1} = -\frac{\rho_1 g I_{xx_1}}{F_1} = -\frac{(55.0 \text{ lbf/ft}^3)(298.7 \text{ ft}^4)}{12,300 \text{ lbf}} = -1.33 \text{ ft}$$

$$y_{CP_2} = -\frac{62.4(126.0)}{26,300} = -0.30 \text{ ft} \quad y_{CP_3} = -\frac{846(37.3)}{70,200} = -0.45 \text{ ft}$$

This locates $z_{CP_1} = -4 - 1.33 = -5.33 \text{ ft}$, $z_{CP_2} = -11 - 0.30 = -11.30 \text{ ft}$, and $z_{CP_3} = -16 - 0.45 = -16.45 \text{ ft}$. Summing moments about the surface then gives

$$\sum F_i z_{CP_i} = F z_{CP}$$

$$\text{or} \quad 12,300(-5.33) + 26,300(-11.30) + 70,200(-16.45) = 108,800 z_{CP}$$

$$\text{or} \quad z_{CP} = -\frac{1,518,000}{108,800} = -13.95 \text{ ft} \quad \text{Ans. (b)}$$

The center of pressure of the total resultant force on the right side of the tank lies 13.95 ft below the surface.

2.8 Buoyancy and Stability

The same principles used to compute hydrostatic forces on surfaces can be applied to the net pressure force on a completely submerged or floating body. The results are the two laws of buoyancy discovered by Archimedes in the third century B.C.:

1. A body immersed in a fluid experiences a vertical buoyant force equal to the weight of the fluid it displaces.
2. A floating body displaces its own weight in the fluid in which it floats.

These two laws are easily derived by referring to Fig. 2.16. In Fig. 2.16*a*, the body lies between an upper curved surface 1 and a lower curved surface 2. From Eq. (2.45) for vertical force, the body experiences a net upward force

$$\begin{aligned} F_B &= F_V(2) - F_V(1) \\ &= (\text{fluid weight above 2}) - (\text{fluid weight above 1}) \\ &= \text{weight of fluid equivalent to body volume} \end{aligned} \quad (2.48)$$

Alternatively, from Fig. 2.16*b*, we can sum the vertical forces on elemental vertical slices through the immersed body:

$$F_B = \int_{\text{body}} (p_2 - p_1) dA_H = -\gamma \int (z_2 - z_1) dA_H = (\gamma)(\text{body volume}) \quad (2.49)$$

These are identical results and equivalent to Archimedes' law 1.

Equation (2.49) assumes that the fluid has uniform specific weight. The line of action of the buoyant force passes through the center of volume of the displaced body; that is, its center of mass is computed as if it had uniform density. This point through which F_B acts is called the *center of buoyancy*, commonly labeled B or CB .

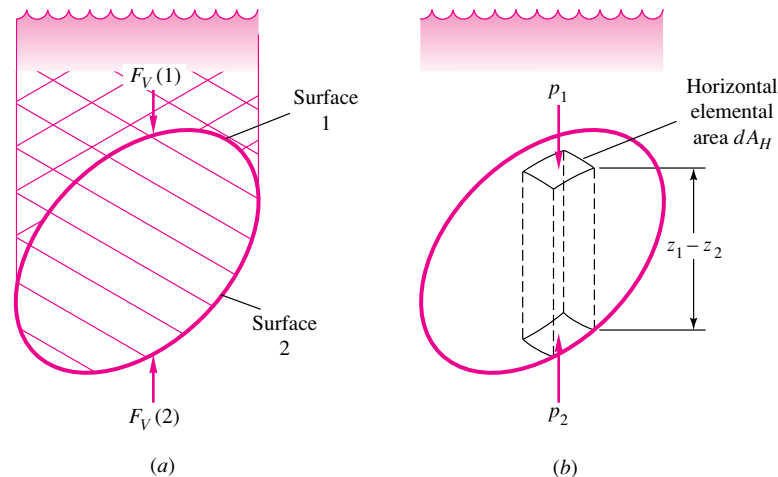

Fig. 2.16 Two different approaches to the buoyant force on an arbitrary immersed body: (a) forces on upper and lower curved surfaces; (b) summation of elemental vertical-pressure forces.

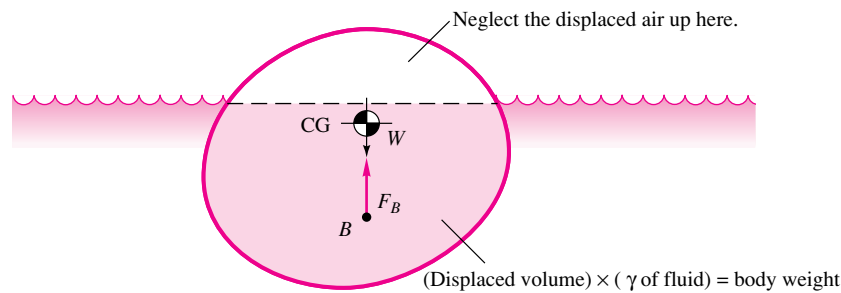

Fig. 2.17 Static equilibrium of a floating body.

on a drawing. Of course, the point B may or may not correspond to the actual center of mass of the body's own material, which may have variable density.

Equation (2.49) can be generalized to a layered fluid (LF) by summing the weights of each layer of density ρ_i displaced by the immersed body:

$$(F_B)_{LF} = \sum \rho_i g (\text{displaced volume})_i \quad (2.50)$$

Each displaced layer would have its own center of volume, and one would have to sum moments of the incremental buoyant forces to find the center of buoyancy of the immersed body.

Since liquids are relatively heavy, we are conscious of their buoyant forces, but gases also exert buoyancy on any body immersed in them. For example, human beings have an average specific weight of about 60 lbf/ft^3 . We may record the weight of a person as 180 lbf and thus estimate the person's total volume as 3.0 ft^3 . However, in so doing we are neglecting the buoyant force of the air surrounding the person. At standard conditions, the specific weight of air is 0.0763 lbf/ft^3 ; hence the buoyant force is approximately 0.23 lbf . If measured in a vacuum, the person would weigh about 0.23 lbf more. For balloons and blimps the buoyant force of air, instead of being negligible, is the controlling factor in the design. Also, many flow phenomena, such as natural convection of heat and vertical mixing in the ocean, are strongly dependent on seemingly small buoyant forces.

Floating bodies are a special case; only a portion of the body is submerged, with the remainder poking up out of the free surface. This is illustrated in Fig. 2.17, where the shaded portion is the displaced volume. Equation (2.49) is modified to apply to this smaller volume:

$$F_B = (\gamma)(\text{displaced volume}) = \text{floating-body weight} \quad (2.51)$$

Not only does the buoyant force equal the body weight, but also they are *collinear* since there can be no net moments for static equilibrium. Equation (2.51) is the mathematical equivalent of Archimedes' law 2, previously stated.

EXAMPLE 2.9

A block of concrete weighs 100 lbf in air and “weighs” only 60 lbf when immersed in fresh water (62.4 lbf/ft^3). What is the average specific weight of the block?

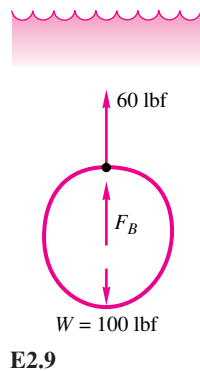
**Solution**

A free-body diagram of the submerged block (see Fig. E2.9) shows a balance between the apparent weight, the buoyant force, and the actual weight:

$$\sum F_z = 0 = 60 + F_B - 100$$

or
$$F_B = 40 \text{ lbf} = (62.4 \text{ lbf/ft}^3)(\text{block volume, ft}^3)$$

Solving gives the volume of the block as $40/62.4 = 0.641 \text{ ft}^3$. Therefore the specific weight of the block is

$$\gamma_{\text{block}} = \frac{100 \text{ lbf}}{0.641 \text{ ft}^3} = 156 \text{ lbf/ft}^3 \quad \text{Ans.}$$

Occasionally, a body will have exactly the right weight and volume for its ratio to equal the specific weight of the fluid. If so, the body will be *neutrally buoyant* and will remain at rest at any point where it is immersed in the fluid. Small neutrally buoyant particles are sometimes used in flow visualization, and a neutrally buoyant body called a *Swallow float* [2] is used to track oceanographic currents. A submarine can achieve positive, neutral, or negative buoyancy by pumping water in or out of its ballast tanks.

Stability

A floating body as in Fig. 2.17 may not approve of the position in which it is floating. If so, it will overturn at the first opportunity and is said to be statically *unstable*, like a pencil balanced on its point. The least disturbance will cause it to seek another equilibrium position that is stable. Engineers must design to avoid floating instability. The only way to tell for sure whether a floating position is stable is to “disturb” the body a slight amount mathematically and see whether it develops a restoring moment that will return it to its original position. If so, it is stable; if not, unstable. Such calculations for arbitrary floating bodies have been honed to a fine art by naval architects [3], but we can at least outline the basic principle of the static stability calculation. Figure 2.18 illustrates the computation for the usual case of a symmetric floating body. The steps are as follows:

1. The basic floating position is calculated from Eq. (2.51). The body’s center of mass G and center of buoyancy B are computed.
2. The body is tilted a small angle $\Delta\theta$, and a new waterline is established for the body to float at this angle. The new position B' of the center of buoyancy is calculated. A vertical line drawn upward from B' intersects the line of symmetry at a point M , called the *metacenter*, which is independent of $\Delta\theta$ for small angles.
3. If point M is above G (that is, if the *metacentric height* \overline{MG} is positive), a restoring moment is present and the original position is stable. If M is below G (negative \overline{MG}), the body is unstable and will overturn if disturbed. Stability increases with increasing \overline{MG} .

Thus the metacentric height is a property of the cross section for the given weight, and its value gives an indication of the stability of the body. For a body of varying

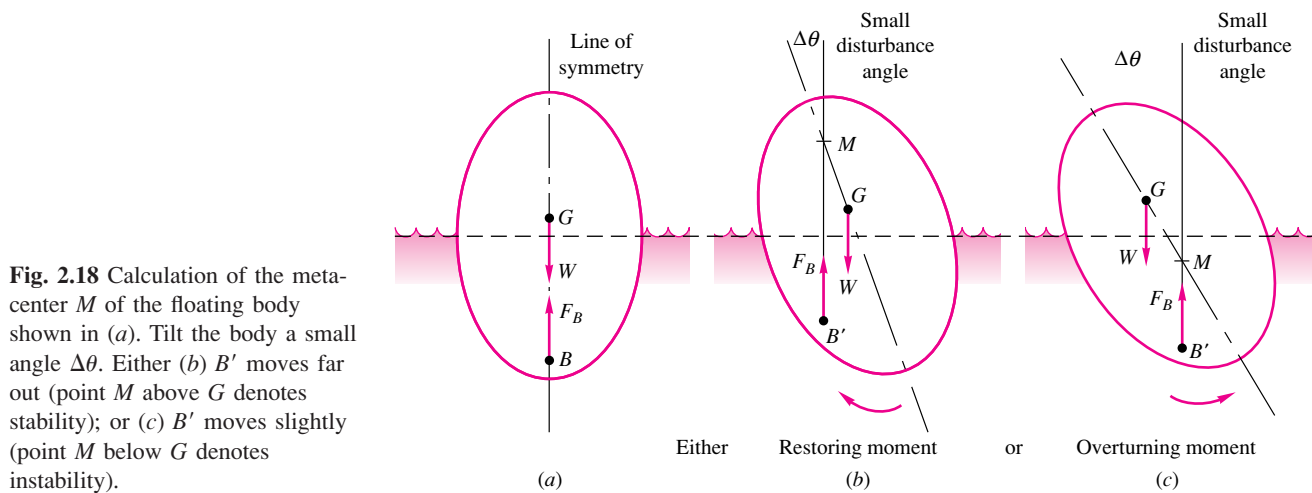

cross section and draft, such as a ship, the computation of the metacenter can be very involved.

Stability Related to Waterline Area

Naval architects [3] have developed the general stability concepts from Fig. 2.18 into a simple computation involving the area moment of inertia of the *waterline area* about the axis of tilt. The derivation assumes that the body has a smooth shape variation (no discontinuities) near the waterline and is derived from Fig. 2.19.

The y axis of the body is assumed to be a line of symmetry. Tilting the body a small angle θ then submerges the small wedge Obd and uncovers an equal wedge cOa , as shown. The new position B' of the center of buoyancy is calculated as the centroid of the submerged portion $aObde$ of the body:

$$\begin{aligned}\bar{x} v_{abOde} &= \int_{cOdea} x dv + \int_{Obd} x dv - \int_{cOa} x dv = 0 + \int_{Obd} x (L dA) - \int_{cOa} x (L dA) \\ &= 0 + \int_{Obd} x L (x \tan \theta dx) - \int_{cOa} x L (-x \tan \theta dx) = \tan \theta \int_{\text{waterline}} x^2 dA_{\text{waterline}} = I_O \tan \theta\end{aligned}$$

where I_O is the area moment of inertia of the *waterline footprint* of the body about its tilt axis O . The first integral vanishes because of the symmetry of the original submerged portion $cOdea$. The remaining two “wedge” integrals combine into I_O when we notice that $L dx$ equals an element of *waterline area*. Thus we determine the desired distance from M to B :

$$\frac{\bar{x}}{\tan \theta} = \overline{MB} = \frac{I_O}{v_{\text{submerged}}} = \overline{MG} + \overline{GB} \quad \text{or} \quad \overline{MG} = \frac{I_O}{v_{\text{sub}}} - \overline{GB} \quad (2.52)$$

The engineer would determine the distance from G to B from the basic shape and design of the floating body and then make the calculation of I_O and the submerged volume v_{sub} . If the metacentric height \overline{MG} is positive, the body is stable for small disturbances. Note that if \overline{GB} is negative, that is, B is *above* G , the body is always stable.

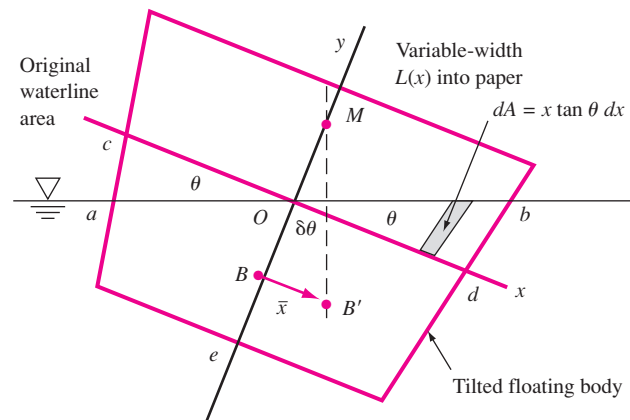
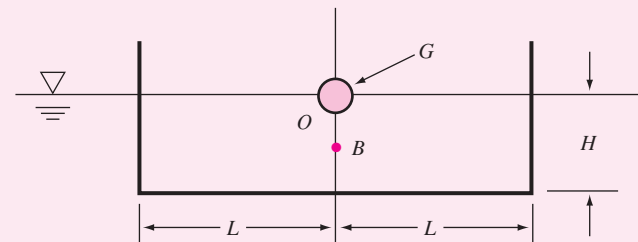

Fig. 2.19 A floating body tilted through a small angle θ . The movement \bar{x} of the center of buoyancy B is related to the waterline area moment of inertia.

EXAMPLE 2.10

A barge has a uniform rectangular cross section of width $2L$ and vertical draft of height H , as in Fig. E2.10. Determine (a) the metacentric height for a small tilt angle and (b) the range of ratio L/H for which the barge is statically stable if G is exactly at the waterline as shown.



E2.10

Solution

If the barge has length b into the paper, the waterline area, relative to tilt axis O , has a base b and a height $2L$; therefore, $I_O = b(2L)^3/12$. Meanwhile, $v_{\text{sub}} = 2LbH$. Equation (2.52) predicts

$$\overline{MG} = \frac{I_O}{v_{\text{sub}}} - \overline{GB} = \frac{8bL^3/12}{2LbH} - \frac{H}{2} = \frac{L^2}{3H} - \frac{H}{2} \quad \text{Ans. (a)}$$

The barge can thus be stable only if

$$L^2 > 3H^2/2 \quad \text{or} \quad 2L > 2.45H \quad \text{Ans. (b)}$$

The wider the barge relative to its draft, the more stable it is. Lowering G would help also.

Even an expert will have difficulty determining the floating stability of a buoyant body of irregular shape. Such bodies may have two or more stable positions. For example, a ship may float the way we like it, so that we can sit on the deck, or it may float upside down (capsized). An interesting mathematical approach to floating stability is given in Ref. 11. The author of this reference points out that even simple shapes, such as a cube of uniform density, may have a great many stable floating

Fig. 2.20 A North Atlantic iceberg formed by calving from a Greenland glacier. These, and their even larger Antarctic sisters, are the largest floating bodies in the world. Note the evidence of further calving fractures on the front surface. (© Corbis.)



orientations, not necessarily symmetric. Homogeneous circular cylinders can float with the axis of symmetry tilted from the vertical.

Floating instability occurs in nature. Fish generally swim with their planes of symmetry vertical. After death, this position is unstable and they float with their flat sides up. Giant icebergs may overturn after becoming unstable when their shapes change due to underwater melting. Iceberg overturning is a dramatic, rarely seen event.

Figure 2.20 shows a typical North Atlantic iceberg formed by calving from a Greenland glacier that protruded into the ocean. The exposed surface is rough, indicating that it has undergone further calving. Icebergs are frozen fresh, bubbly, glacial water of average density 900 kg/m^3 . Thus, when an iceberg is floating in seawater, whose average density is 1025 kg/m^3 , approximately $900/1025$, or seven-eighths, of its volume lies below the water.

2.9 Pressure Distribution in Rigid-Body Motion

In rigid-body motion, all particles are in combined translation and rotation, and there is no relative motion between particles. With no relative motion, there are no strains or strain rates, so that the viscous term $\mu \nabla^2 \mathbf{V}$ in Eq. (2.13) vanishes, leaving a balance between pressure, gravity, and particle acceleration:

$$\nabla p = \rho(\mathbf{g} - \mathbf{a}) \quad (2.53)$$

The pressure gradient acts in the direction $\mathbf{g} - \mathbf{a}$, and lines of constant pressure (including the free surface, if any) are perpendicular to this direction. The general case of combined translation and rotation of a rigid body is discussed in Chap. 3, Fig. 3.12. If the center of rotation is at point O and the translational velocity is \mathbf{V}_0 at this point, the velocity of an arbitrary point P on the body is given by²

$$\mathbf{V} = \mathbf{V}_0 + \boldsymbol{\Omega} \times \mathbf{r}_0$$

where $\boldsymbol{\Omega}$ is the angular-velocity vector and \mathbf{r}_0 is the position of point P . Differentiating, we obtain the most general form of the acceleration of a rigid body:

$$\mathbf{a} = \frac{d\mathbf{V}_0}{dt} + \boldsymbol{\Omega} \times (\boldsymbol{\Omega} \times \mathbf{r}_0) + \frac{d\boldsymbol{\Omega}}{dt} \times \mathbf{r}_0 \quad (2.54)$$

²For a more detailed derivation of rigid-body motion, see Ref. 4, Sec. 2.7.

Looking at the right-hand side, we see that the first term is the translational acceleration; the second term is the *centripetal acceleration*, whose direction is from point P perpendicular toward the axis of rotation; and the third term is the linear acceleration due to changes in the angular velocity. It is rare for all three of these terms to apply to any one fluid flow. In fact, fluids can rarely move in rigid-body motion unless restrained by confining walls for a long time. For example, suppose a tank of water is in a car that starts a constant acceleration. The water in the tank would begin to slosh about, and that sloshing would damp out very slowly until finally the particles of water would be in approximately rigid-body acceleration. This would take so long that the car would have reached hypersonic speeds. Nevertheless, we can at least discuss the pressure distribution in a tank of rigidly accelerating water. The following is an example where the water in the tank will reach uniform acceleration rapidly.

EXAMPLE 2.11

A tank of water 1 m deep is in free fall under gravity with negligible drag. Compute the pressure at the bottom of the tank if $p_a = 101$ kPa.

Solution

Being unsupported in this condition, the water particles tend to fall downward as a rigid hunk of fluid. In free fall with no drag, the downward acceleration is $\mathbf{a} = \mathbf{g}$. Thus Eq. (2.53) for this situation gives $\nabla p = \rho(\mathbf{g} - \mathbf{g}) = 0$. The pressure in the water is thus *constant everywhere* and equal to the atmospheric pressure 101 kPa. In other words, the walls are doing no service in sustaining the pressure distribution that would normally exist.

Uniform Linear Acceleration

In this general case of uniform rigid-body acceleration, Eq. (2.53) applies, \mathbf{a} having the same magnitude and direction for all particles. With reference to Fig. 2.21, the parallelogram sum of \mathbf{g} and $-\mathbf{a}$ gives the direction of the pressure gradient or greatest

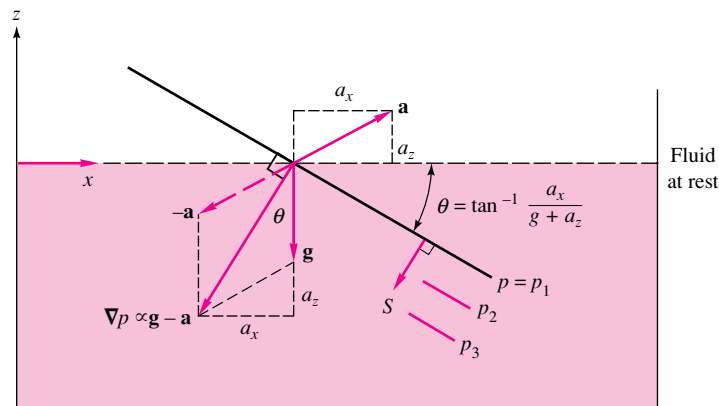

Fig. 2.21 Tilting of constant-pressure surfaces in a tank of liquid in rigid-body acceleration.

rate of increase of p . The surfaces of constant pressure must be perpendicular to this and are thus tilted at a downward angle θ such that

$$\theta = \tan^{-1} \frac{a_x}{g + a_z} \quad (2.55)$$

One of these tilted lines is the free surface, which is found by the requirement that the fluid retain its volume unless it spills out. The rate of increase of pressure in the direction $\mathbf{g} - \mathbf{a}$ is greater than in ordinary hydrostatics and is given by

$$\frac{dp}{ds} = \rho G \quad \text{where } G = [a_x^2 + (g + a_z)^2]^{1/2} \quad (2.56)$$

These results are independent of the size or shape of the container as long as the fluid is continuously connected throughout the container.

EXAMPLE 2.12

A drag racer rests her coffee mug on a horizontal tray while she accelerates at 7 m/s^2 . The mug is 10 cm deep and 6 cm in diameter and contains coffee 7 cm deep at rest. (a) Assuming rigid-body acceleration of the coffee, determine whether it will spill out of the mug. (b) Calculate the gage pressure in the corner at point A if the density of coffee is 1010 kg/m^3 .

Solution

- *System sketch:* Figure E2.12 shows the coffee tilted during the acceleration.

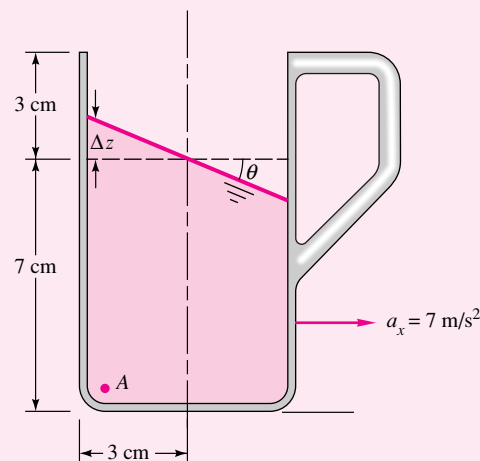

E2.12

- *Assumptions:* Rigid-body horizontal acceleration, $a_x = 7 \text{ m/s}^2$. Symmetric coffee cup.
- *Property values:* Density of coffee given as 1010 kg/m^3 .
- *Approach (a):* Determine the angle of tilt from the known acceleration, then find the height rise.
- *Solution steps:* From Eq. (2.55), the angle of tilt is given by

$$\theta = \tan^{-1} \frac{a_x}{g} = \tan^{-1} \frac{7.0 \text{ m/s}^2}{9.81 \text{ m/s}^2} = 35.5^\circ$$

If the mug is symmetric, the tilted surface will pass through the center point of the rest position, as shown in Fig. E2.12. Then the rear side of the coffee free surface will rise an amount Δz given by

$$\Delta z = (3 \text{ cm})(\tan 35.5^\circ) = 2.14 \text{ cm} < 3 \text{ cm} \quad \text{therefore no spilling} \quad \text{Ans. (a)}$$

- *Comment (a):* This solution neglects sloshing, which might occur if the start-up is uneven.
- *Approach (b):* The pressure at A can be computed from Eq. (2.56), using the perpendicular distance Δs from the surface to A. When at rest, $p_A = \rho g h_{\text{rest}} = (1010 \text{ kg/m}^3)(9.81 \text{ m/s}^2)(0.07 \text{ m}) = 694 \text{ Pa}$. When accelerating,

$$p_A = \rho G \Delta s = \left(1010 \frac{\text{kg}}{\text{m}^3}\right) \left[\sqrt{(9.81)^2 + (7.0)^2}\right] [(0.07 + 0.0214) \cos 35.5^\circ] \approx 906 \text{ Pa} \quad \text{Ans. (b)}$$

- *Comment (b):* The acceleration has increased the pressure at A by 31%. Think about this alternative: why does it work? Since $a_z = 0$, we may proceed vertically down the left side to compute

$$p_A = \rho g(z_{\text{surf}} - z_A) = (1010 \text{ kg/m}^3)(9.81 \text{ m/s}^2)(0.0214 + 0.07 \text{ m}) = 906 \text{ Pa}$$

Rigid-Body Rotation

As a second special case, consider rotation of the fluid about the z axis without any translation, as sketched in Fig. 2.22. We assume that the container has been rotating long enough at constant Ω for the fluid to have attained rigid-body rotation. The fluid acceleration will then be the centripetal term in Eq. (2.54). In the coordinates of Fig. 2.22, the angular-velocity and position vectors are given by

$$\boldsymbol{\Omega} = \mathbf{k}\Omega \quad \mathbf{r}_0 = \mathbf{i}_r r \quad (2.57)$$

Then the acceleration is given by

$$\boldsymbol{\Omega} \times (\boldsymbol{\Omega} \times \mathbf{r}_0) = -r\Omega^2 \mathbf{i}_r \quad (2.58)$$

Fig. 2.22 Development of paraboloid constant-pressure surfaces in a fluid in rigid-body rotation. The dashed line along the direction of maximum pressure increase is an exponential curve.

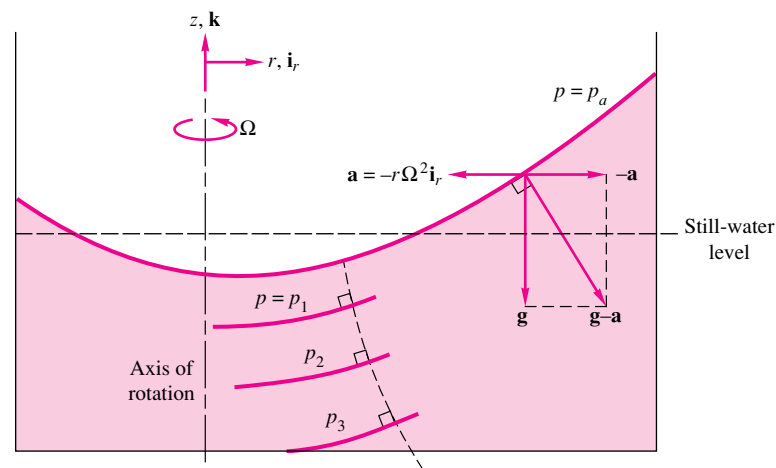

as marked in the figure, and Eq. (2.53) for the force balance becomes

$$\nabla p = \mathbf{i}_r \frac{\partial p}{\partial r} + \mathbf{k} \frac{\partial p}{\partial z} = \rho(\mathbf{g} - \mathbf{a}) = \rho(-g\mathbf{k} + r\Omega^2\mathbf{i}_r) \quad (2.59)$$

Equating like components, we find the pressure field by solving two first-order partial differential equations:

$$\frac{\partial p}{\partial r} = \rho r \Omega^2 \quad \frac{\partial p}{\partial z} = -\gamma \quad (2.60)$$

This is our first specific example of the generalized three-dimensional problem described by Eqs. (2.14) for more than one independent variable. The right-hand sides of (2.60) are known functions of r and z . One can proceed as follows: Integrate the first equation “partially,” holding z constant, with respect to r . The result is

$$p = \frac{1}{2}\rho r^2 \Omega^2 + f(z) \quad (2.61)$$

where the “constant” of integration is actually a function $f(z)$.³ Now differentiate this with respect to z and compare with the second relation of (2.60):

$$\frac{\partial p}{\partial z} = 0 + f'(z) = -\gamma$$

or

$$f(z) = -\gamma z + C \quad (2.62a)$$

where C is a constant. Thus Eq. (2.61) now becomes

$$p = \text{const} - \gamma z + \frac{1}{2}\rho r^2 \Omega^2 \quad (2.62b)$$

This is the pressure distribution in the fluid. The value of C is found by specifying the pressure at one point. If $p = p_0$ at $(r, z) = (0, 0)$, then $C = p_0$. The final desired distribution is

$$p = p_0 - \gamma z + \frac{1}{2}\rho r^2 \Omega^2 \quad (2.63)$$

The pressure is linear in z and parabolic in r . If we wish to plot a constant-pressure surface, say, $p = p_1$, Eq. (2.63) becomes

$$z = \frac{p_0 - p_1}{\gamma} + \frac{r^2 \Omega^2}{2g} = a + br^2 \quad (2.64)$$

Thus the surfaces are paraboloids of revolution, concave upward, with their minimum points on the axis of rotation. Some examples are sketched in Fig. 2.22.

As in the previous example of linear acceleration, the position of the free surface is found by conserving the volume of fluid. For a noncircular container with the axis of rotation off-center, as in Fig. 2.22, a lot of laborious mensuration is required, and a single problem will take you all weekend. However, the calculation is easy for a cylinder rotating about its central axis, as in Fig. 2.23. Since the volume of a paraboloid is one-half the base area times its height, the still-water level is exactly halfway between the high and low points of the free surface. The center of the fluid drops an amount $h/2 = \Omega^2 R^2 / (4g)$, and the edges rise an equal amount.

³This is because $f(z)$ vanishes when differentiated with respect to r . If you don't see this, you should review your calculus.

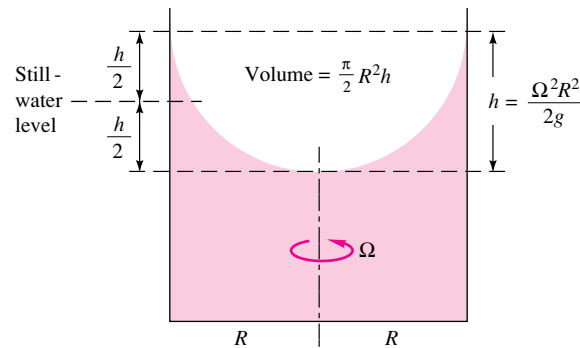

Fig. 2.23 Determining the free-surface position for rotation of a cylinder of fluid about its central axis.

EXAMPLE 2.13

The coffee cup in Example 2.12 is removed from the drag racer, placed on a turntable, and rotated about its central axis until a rigid-body mode occurs. Find (a) the angular velocity that will cause the coffee to just reach the lip of the cup and (b) the gage pressure at point A for this condition.

Solution

Part (a)

The cup contains 7 cm of coffee. The remaining distance of 3 cm up to the lip must equal the distance $h/2$ in Fig. 2.23. Thus

$$\frac{h}{2} = 0.03 \text{ m} = \frac{\Omega^2 R^2}{4g} = \frac{\Omega^2 (0.03 \text{ m})^2}{4(9.81 \text{ m/s}^2)}$$

Solving, we obtain

$$\Omega^2 = 1308 \quad \text{or} \quad \Omega = 36.2 \text{ rad/s} = 345 \text{ r/min} \quad \text{Ans. (a)}$$

Part (b)

To compute the pressure, it is convenient to put the origin of coordinates r and z at the bottom of the free-surface depression, as shown in Fig. E2.13. The gage pressure here is $p_0 = 0$, and point A is at $(r, z) = (3 \text{ cm}, -4 \text{ cm})$. Equation (2.63) can then be evaluated:

$$\begin{aligned} p_A &= 0 - (1010 \text{ kg/m}^3)(9.81 \text{ m/s}^2)(-0.04 \text{ m}) \\ &\quad + \frac{1}{2}(1010 \text{ kg/m}^3)(0.03 \text{ m})^2(1308 \text{ rad}^2/\text{s}^2) \\ &= 396 \text{ N/m}^2 + 594 \text{ N/m}^2 = 990 \text{ Pa} \quad \text{Ans. (b)} \end{aligned}$$

This is about 43 percent greater than the still-water pressure $p_A = 694 \text{ Pa}$.

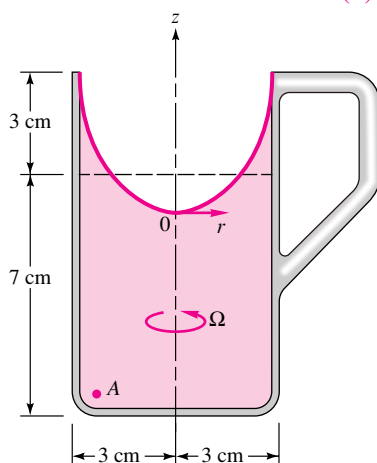

E2.13

Here, as in the linear acceleration case, it should be emphasized that the paraboloid pressure distribution (2.63) sets up in *any* fluid under rigid-body rotation, regardless of the shape or size of the container. The container may even be closed and filled with fluid. It is only necessary that the fluid be continuously interconnected throughout the container. The following example will illustrate a peculiar case in which one can visualize an imaginary free surface extending outside the walls of the container.

100 Chapter 2 Pressure Distribution in a Fluid

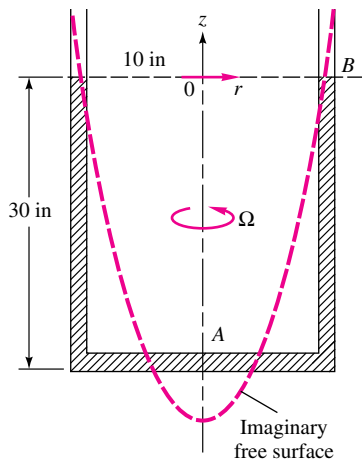

E2.14

EXAMPLE 2.14

A U-tube with a radius of 10 in and containing mercury to a height of 30 in is rotated about its center at 180 r/min until a rigid-body mode is achieved. The diameter of the tubing is negligible. Atmospheric pressure is 2116 lbf/ft². Find the pressure at point A in the rotating condition. See Fig. E2.14.

Solution

Convert the angular velocity to radians per second:

$$\Omega = (180 \text{ r/min}) \frac{2\pi \text{ rad/r}}{60 \text{ s/min}} = 18.85 \text{ rad/s}$$

From Table 2.1 we find for mercury that $\gamma = 846 \text{ lbf/ft}^3$ and hence $\rho = 846/32.2 = 26.3 \text{ slugs/ft}^3$. At this high rotation rate, the free surface will slant upward at a fierce angle [about 84°; check this from Eq. (2.64)], but the tubing is so thin that the free surface will remain at approximately the same 30-in height, point B. Placing our origin of coordinates at this height, we can calculate the constant C in Eq. (2.62b) from the condition $p_B = 2116 \text{ lbf/ft}^2$ at $(r, z) = (10 \text{ in}, 0)$:

$$p_B = 2116 \text{ lbf/ft}^2 = C - 0 + \frac{1}{2}(26.3 \text{ slugs/ft}^3)\left(\frac{10}{12} \text{ ft}\right)^2(18.85 \text{ rad/s})^2$$

or

$$C = 2116 - 3245 = -1129 \text{ lbf/ft}^2$$

We then obtain p_A by evaluating Eq. (2.63) at $(r, z) = (0, -30 \text{ in})$:

$$p_A = -1129 - (846 \text{ lbf/ft}^3)\left(-\frac{30}{12} \text{ ft}\right) = -1129 + 2115 = 986 \text{ lbf/ft}^2 \quad \text{Ans.}$$

This is less than atmospheric pressure, and we can see why if we follow the free-surface paraboloid down from point B along the dashed line in the figure. It will cross the horizontal portion of the U-tube (where p will be atmospheric) and fall below point A. From Fig. 2.23 the actual drop from point B will be

$$h = \frac{\Omega^2 R^2}{2g} = \frac{(18.85)^2 \left(\frac{10}{12}\right)^2}{2(32.2)} = 3.83 \text{ ft} = 46 \text{ in}$$

Thus p_A is about 16 inHg below atmospheric pressure, or about $\frac{16}{12}(846) = 1128 \text{ lbf/ft}^2$ below $p_a = 2116 \text{ lbf/ft}^2$, which checks with the answer above. When the tube is at rest,

$$p_A = 2116 - 846\left(-\frac{30}{12}\right) = 4231 \text{ lbf/ft}^2$$

Hence rotation has reduced the pressure at point A by 77 percent. Further rotation can reduce p_A to near-zero pressure, and cavitation can occur.

An interesting by-product of this analysis for rigid-body rotation is that the lines everywhere parallel to the pressure gradient form a family of curved surfaces, as sketched in Fig. 2.22. They are everywhere orthogonal to the constant-pressure surfaces, and hence their slope is the negative inverse of the slope computed from Eq. (2.64):

$$\left. \frac{dz}{dr} \right|_{GL} = -\frac{1}{(dz/dr)_{p=\text{const}}} = -\frac{1}{r\Omega^2/g}$$

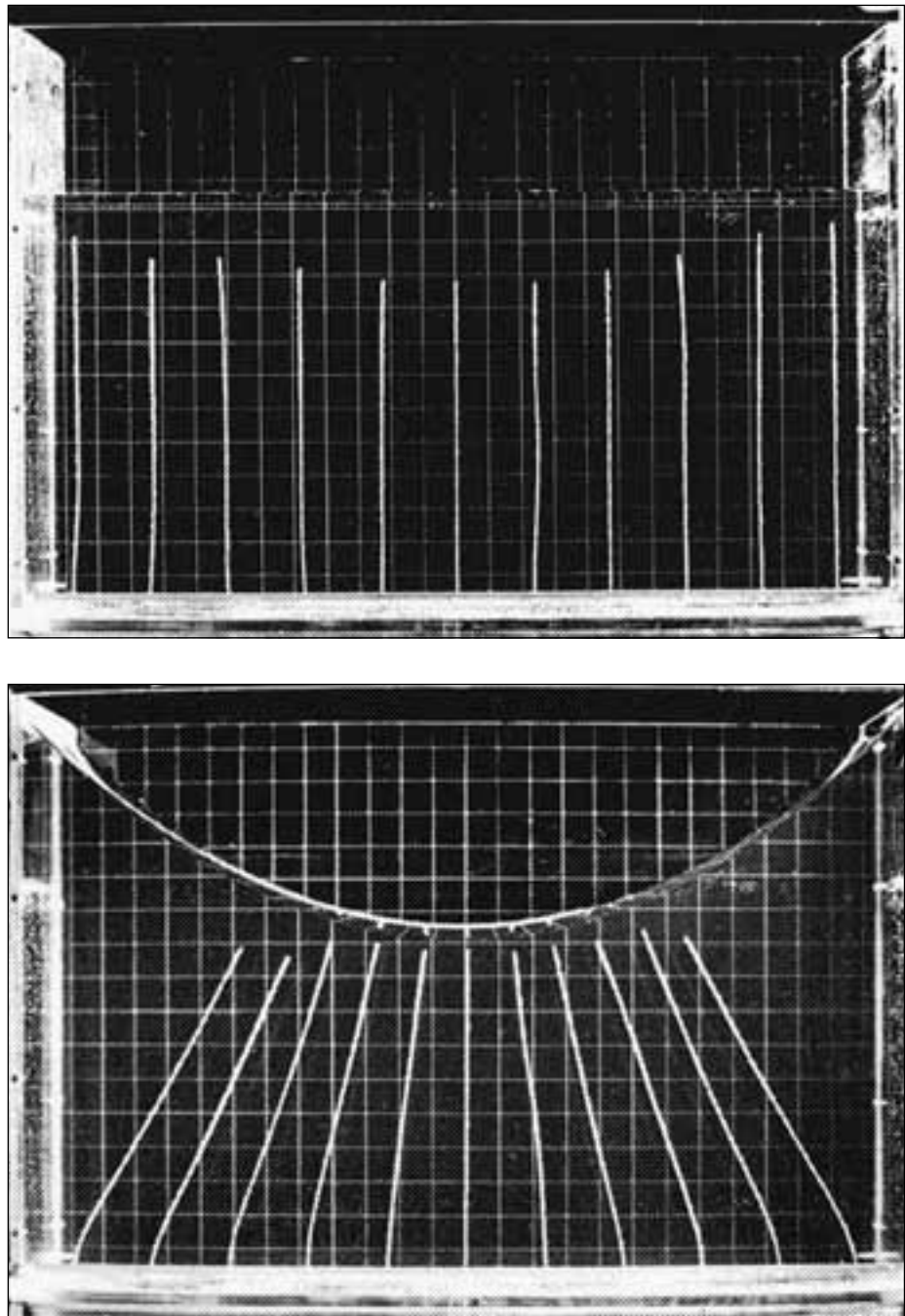

Fig. 2.24 Experimental demonstration with buoyant streamers of the fluid force field in rigid-body rotation: (*top*) fluid at rest (streamers hang vertically upward); (*bottom*) rigid-body rotation (streamers are aligned with the direction of maximum pressure gradient). (© *The American Association of Physics Teachers*. Reprinted with permission from 'The Apparent Field of Gravity in a Rotating Fluid System' by R. Ian Fletcher. *American Journal of Physics* vol. 40, pp. 959–965, July 1972.)

102 Chapter 2 Pressure Distribution in a Fluid

where GL stands for gradient line

$$\text{or} \quad \frac{dz}{dr} = -\frac{g}{r\Omega^2} \quad (2.65)$$

Separating the variables and integrating, we find the equation of the pressure-gradient surfaces:

$$r = C_1 \exp\left(-\frac{\Omega^2 z}{g}\right) \quad (2.66)$$

Notice that this result and Eq. (2.64) are independent of the density of the fluid. In the absence of friction and Coriolis effects, Eq. (2.66) defines the lines along which the apparent net gravitational field would act on a particle. Depending on its density, a small particle or bubble would tend to rise or fall in the fluid along these exponential lines, as demonstrated experimentally in Ref. 5. Also, buoyant streamers would align themselves with these exponential lines, thus avoiding any stress other than pure tension. Figure 2.24 shows the configuration of such streamers before and during rotation.

2.10 Pressure Measurement

Pressure is a derived property. It is the force per unit area as related to fluid molecular bombardment of a surface. Thus most pressure instruments only *infer* the pressure by calibration with a primary device such as a deadweight piston tester. There are many such instruments, for both a static fluid and a moving stream. The instrumentation texts in Refs. 7 to 10, 12, and 13 list over 20 designs for pressure measurement instruments. These instruments may be grouped into four categories:

1. *Gravity-based*: barometer, manometer, deadweight piston.
2. *Elastic deformation*: bourdon tube (metal and quartz), diaphragm, bellows, strain-gage, optical beam displacement.
3. *Gas behavior*: gas compression (McLeod gage), thermal conductance (Pirani gage), molecular impact (Knudsen gage), ionization, thermal conductivity, air piston.
4. *Electric output*: resistance (Bridgman wire gage), diffused strain gage, capacitive, piezoelectric, potentiometric, magnetic inductance, magnetic reluctance, linear variable differential transformer (LVDT), resonant frequency.
5. *Luminescent coatings* for surface pressures [15].

The gas-behavior gages are mostly special-purpose instruments used for certain scientific experiments. The deadweight tester is the instrument used most often for calibrations; for example, it is used by the U.S. National Institute for Standards and Technology (NIST). The barometer is described in Fig. 2.6.

The manometer, analyzed in Sec. 2.4, is a simple and inexpensive hydrostatic-principle device with no moving parts except the liquid column itself. Manometer measurements must not disturb the flow. The best way to do this is to take the measurement through a *static hole* in the wall of the flow, as illustrated for the two instruments in Fig. 2.25. The hole should be normal to the wall, and burrs should be avoided.

Fig. 2.25 Two types of accurate manometers for precise measurements: (a) tilted tube with eyepiece; (b) micrometer pointer with ammeter detector.

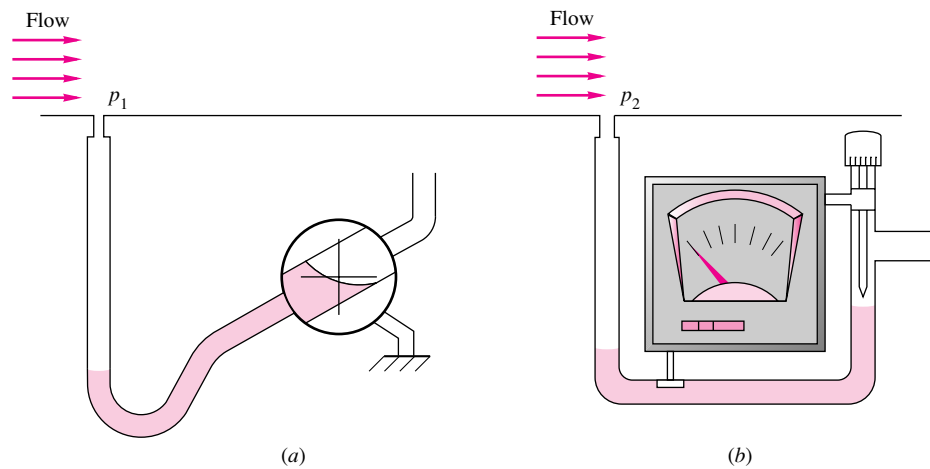

If the hole is small enough (typically 1-mm diameter), there will be no flow into the measuring tube once the pressure has adjusted to a steady value. Thus the flow is almost undisturbed. An oscillating flow pressure, however, can cause a large error due to possible dynamic response of the tubing. Other devices of smaller dimensions are used for dynamic-pressure measurements. Note that the manometers in Fig. 2.25 are arranged to measure the separate pressures p_1 and p_2 . If the pressure difference $p_1 - p_2$ is desired, a significant error is incurred by subtracting two independent measurements, and it would be far better to connect both ends of one instrument to the two static holes p_1 and p_2 so that one manometer reads the difference directly.

In category 2, elastic-deformation instruments, a popular, inexpensive, and reliable device is the *bourdon tube*, sketched in Fig. 2.26. When pressurized internally, a

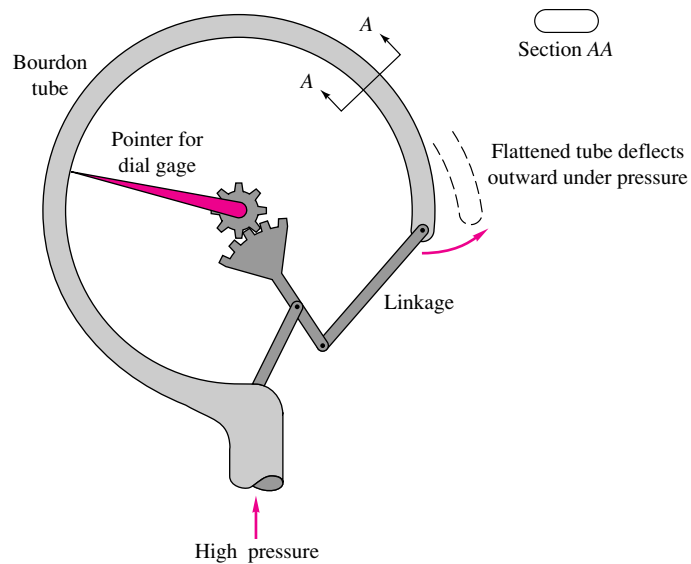

Fig. 2.26 Schematic of a bourdon-tube device for mechanical measurement of high pressures.

curved tube with flattened cross section will deflect outward. The deflection can be measured by a linkage attached to a calibrated dial pointer, as shown. Or the deflection can be used to drive electric-output sensors, such as a variable transformer. Similarly, a membrane or *diaphragm* will deflect under pressure and can either be sensed directly or used to drive another sensor.

An interesting variation of Fig. 2.26 is the *fused-quartz, force-balanced bourdon tube*, shown in Fig. 2.27, whose spiral-tube deflection is sensed optically and returned to a zero reference state by a magnetic element whose output is proportional to the fluid pressure. The fused-quartz, force-balanced bourdon tube is reported to be one of the most accurate pressure sensors ever devised, with uncertainty on the order of ± 0.003 percent.

The quartz gages, both the bourdon type and the resonant type, are expensive but extremely accurate, stable, and reliable [14]. They are often used for deep-ocean pressure measurements, which detect long waves and tsunami activity over extensive time periods.

The last category, *electric-output sensors*, is extremely important in engineering because the data can be stored on computers and freely manipulated, plotted, and analyzed. Three examples are shown in Fig. 2.28, the first being the *capacitive* sensor in Fig. 2.28a. The differential pressure deflects the silicon diaphragm and changes the capacitance of the liquid in the cavity. Note that the cavity has spherical end caps to prevent overpressure damage. In the second type, Fig. 2.28b, strain gages and other sensors are chemically diffused or etched onto a chip, which is stressed by the applied pressure. Finally, in Fig. 2.28c, a micromachined silicon sensor is arranged to deform under pressure such that its natural vibration frequency is proportional to the pressure. An oscillator excites the element's resonant frequency and converts it into appropriate pressure units.

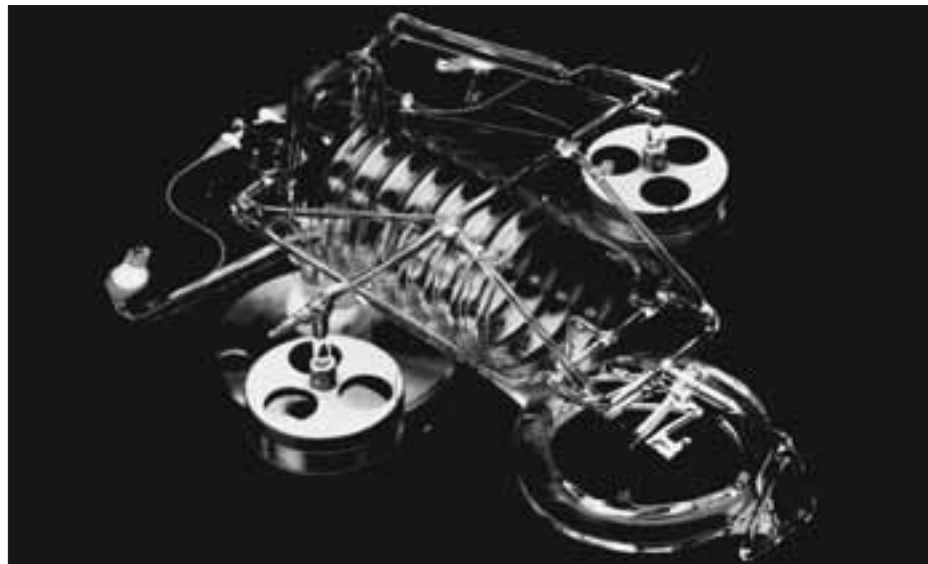
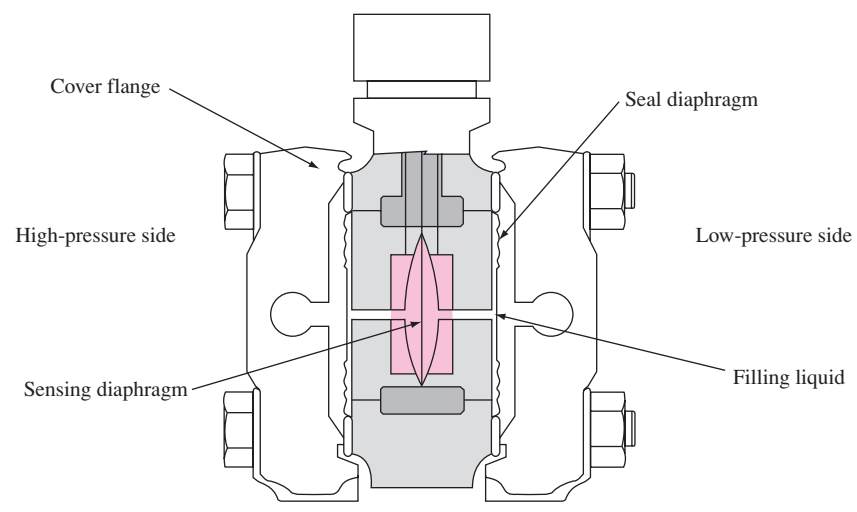
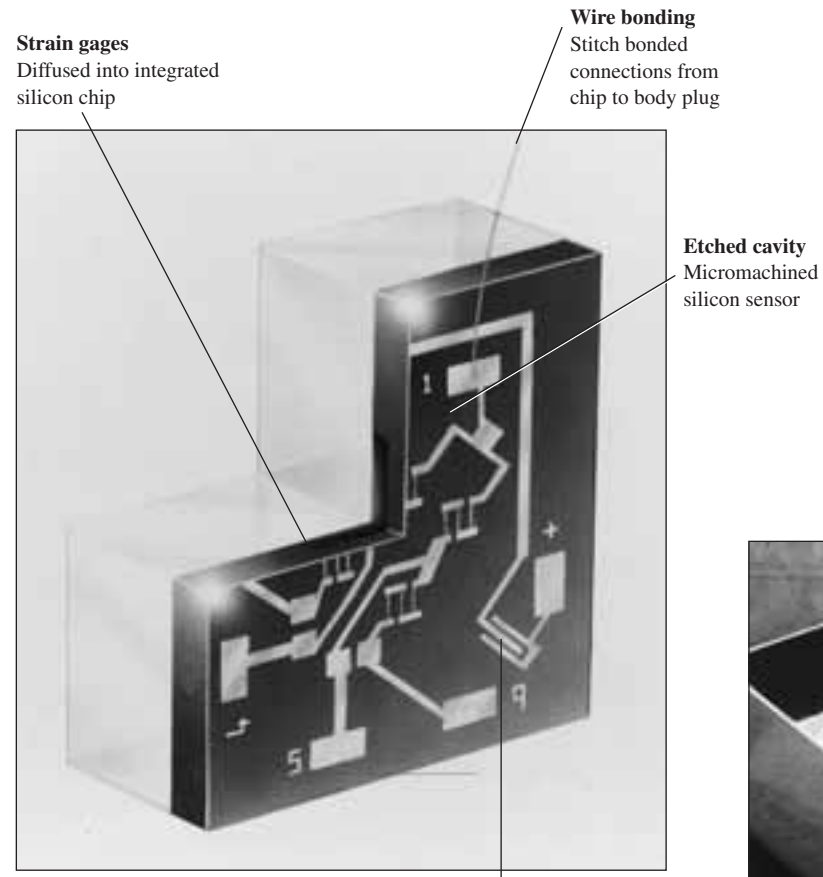

Fig. 2.27 The fused-quartz, force-balanced bourdon tube is the most accurate pressure sensor used in commercial applications today. (Courtesy of Ruska Instrument Corporation, Houston, TX.)



(a)



(b)



(c)

Fig. 2.28 Pressure sensors with electric output: (a) a silicon diaphragm whose deflection changes the cavity capacitance (Courtesy of Johnson-Yokogawa Inc.); (b) a silicon strain gage that is stressed by applied pressure; (c) a micromachined silicon element that resonates at a frequency proportional to applied pressure. [(b) and (c) are courtesy of Druck, Inc., Fairfield, CT.]

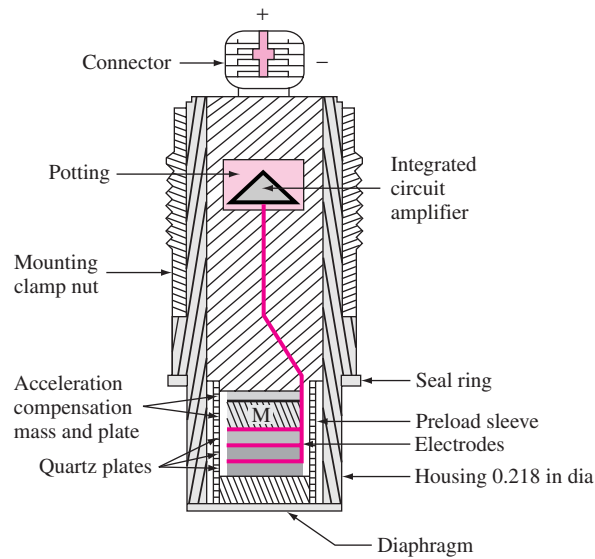

Fig. 2.29 A piezoelectric transducer measures rapidly changing pressures. (Courtesy of PCB Piezotronics, Inc. Depew, New York.)

Another kind of dynamic electric-output sensor is the *piezoelectric transducer*, shown in Fig. 2.29. The sensing elements are thin layers of quartz, which generate an electric charge when subjected to stress. The design in Fig. 2.29 is flush-mounted on a solid surface and can sense rapidly varying pressures, such as blast waves. Other designs are of the cavity type. This type of sensor primarily detects transient pressures, not steady stress, but if highly insulated can also be used for short-term static events. Note also that it measures *gage* pressure—that is, it detects only a change from ambient conditions.

Summary

This chapter has been devoted entirely to the computation of pressure distributions and the resulting forces and moments in a static fluid or a fluid with a known velocity field. All hydrostatic (Secs. 2.3 to 2.8) and rigid-body (Sec. 2.9) problems are solved in this manner and are classic cases that every student should understand. In arbitrary viscous flows, both pressure and velocity are unknowns and are solved together as a system of equations in the chapters that follow.

Problems

Most of the problems herein are fairly straightforward. More difficult or open-ended assignments are indicated with an asterisk, as in Prob. 2.9. Problems labeled with an EES icon (for example, Prob. 2.62), will benefit from the use of the Engineering Equation Solver (EES), while problems labeled with a disk icon may

require the use of a computer. The standard end-of-chapter problems 2.1 to 2.159 (categorized in the problem distribution) are followed by word problems W2.1 to W2.8, fundamentals of engineering exam problems FE2.1 to FE2.10, comprehensive problems C2.1 to C2.6, and design projects D2.1 to D2.3.

Problem Distribution

Section	Topic	Problems
2.1, 2.2	Stresses; pressure gradient; gage pressure	2.1–2.6
2.3	Hydrostatic pressure; barometers	2.7–2.23
2.3	The atmosphere	2.24–2.29
2.4	Manometers; multiple fluids	2.30–2.47
2.5	Forces on plane surfaces	2.48–2.81
2.6	Forces on curved surfaces	2.82–2.100
2.7	Forces in layered fluids	2.101–2.102
2.8	Buoyancy; Archimedes' principles	2.103–2.126
2.8	Stability of floating bodies	2.127–2.136
2.9	Uniform acceleration	2.137–2.151
2.9	Rigid-body rotation	2.152–2.159
2.10	Pressure measurements	None

P2.1 For the two-dimensional stress field shown in Fig. P2.1 it is found that

$$\sigma_{xx} = 3000 \text{ lbf/ft}^2 \quad \sigma_{yy} = 2000 \text{ lbf/ft}^2 \quad \sigma_{xy} = 500 \text{ lbf/ft}^2$$

Find the shear and normal stresses (in lbf/ft²) acting on plane AA cutting through the element at a 30° angle as shown.

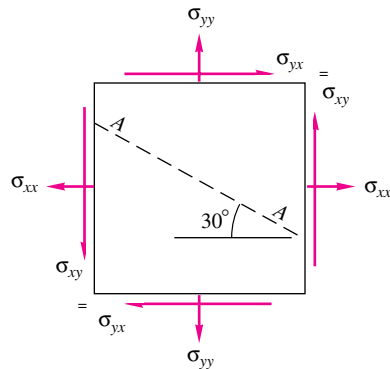

P2.1

P2.2 For the two-dimensional stress field shown in Fig. P2.1 suppose that

$$\sigma_{xx} = 2000 \text{ lbf/ft}^2 \quad \sigma_{yy} = 3000 \text{ lbf/ft}^2 \quad \sigma_n(AA) = 2500 \text{ lbf/ft}^2$$

Compute (a) the shear stress σ_{xy} and (b) the shear stress on plane AA.

P2.3 A vertical, clean, glass piezometer tube has an inside diameter of 1 mm. When pressure is applied, water at 20°C rises into the tube to a height of 25 cm. After correcting for surface tension, estimate the applied pressure in Pa.

P2.4 In a certain two-dimensional fluid flow pattern the lines of constant pressure, or *isobars*, are defined by the expression $P_0 - Bz + Cx^2 = \text{constant}$, where B and C

are constants and p_0 is the (constant) pressure at the origin, $(x, z) = (0, 0)$. Find an expression $x = f(z)$ for the family of lines that are everywhere parallel to the local pressure gradient ∇p .

P2.5 Atlanta, Georgia, has an average altitude of 1100 ft. On a standard day (Table A.6), pressure gage A in a laboratory experiment reads 93 kPa and gage B reads 105 kPa. Express these readings in gage pressure or vacuum pressure (Pa), whichever is appropriate.

P2.6 Any pressure reading can be expressed as a length or *head*, $h = p/\rho g$. What is standard sea-level pressure expressed in (a) ft of ethylene glycol, (b) in Hg, (c) m of water, and (d) mm of methanol? Assume all fluids are at 20°C.

P2.7 The deepest known point in the ocean is 11,034 m in the Mariana Trench in the Pacific. At this depth the specific weight of seawater is approximately 10,520 N/m³. At the surface, $\gamma \approx 10,050 \text{ N/m}^3$. Estimate the absolute pressure at this depth, in atm.

P2.8 A diamond mine is two miles below sea level. (a) Estimate the air pressure at this depth. (b) If a barometer, accurate to 1 mm of mercury, is carried into this mine, how accurately can it estimate the depth of the mine? List your assumptions carefully.

***P2.9** For a liquid, integrate the hydrostatic relation, Eq. (2.18), by assuming that the *isentropic bulk modulus*, $B = \rho(\partial p/\partial \rho)_s$, is constant—see Eq. (9.18). Find an expression for $p(z)$ and apply the Mariana Trench data as in Prob. 2.7, using B_{seawater} from Table A.3.

P2.10 A closed tank contains 1.5 m of SAE 30 oil, 1 m of water, 20 cm of mercury, and an air space on top, all at 20°C. The absolute pressure at the bottom of the tank is 60 kPa. What is the pressure in the air space?

P2.11 In Fig. P2.11, pressure gage A reads 1.5 kPa (gage). The fluids are at 20°C. Determine the elevations z , in meters, of the liquid levels in the open piezometer tubes B and C.

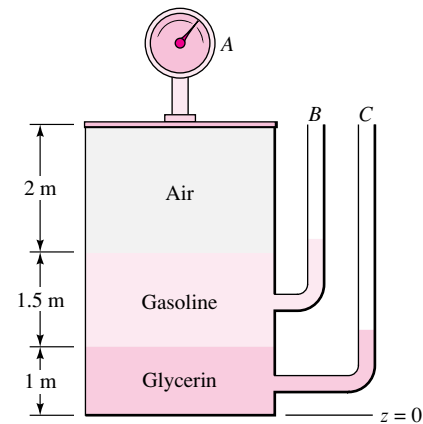

P2.11

108 Chapter 2 Pressure Distribution in a Fluid

- P2.12** In Fig. P2.12 the tank contains water and immiscible oil at 20°C. What is h in cm if the density of the oil is 898 kg/m^3 ?

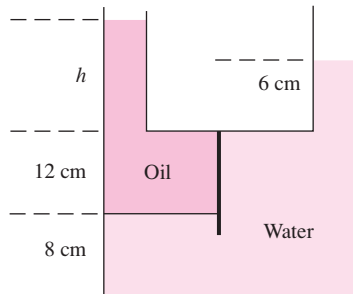

P2.12

- P2.13** In Fig. P2.13 the 20°C water and gasoline surfaces are open to the atmosphere and at the same elevation. What is the height h of the third liquid in the right leg?

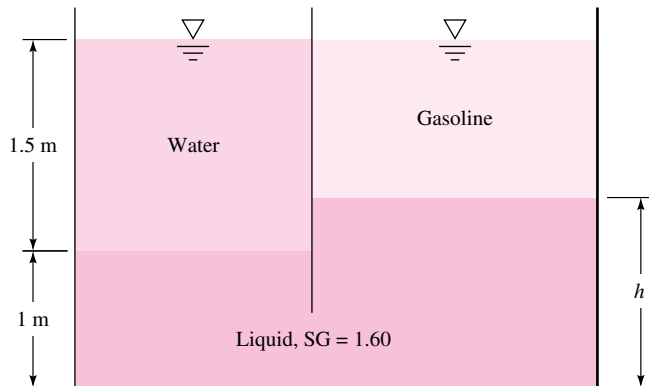

P2.13

- P2.14** The closed tank in Fig. P2.14 is at 20°C. If the pressure at point A is 95 kPa absolute, what is the absolute pressure at point B in kPa? What percentage error do you make by neglecting the specific weight of the air?

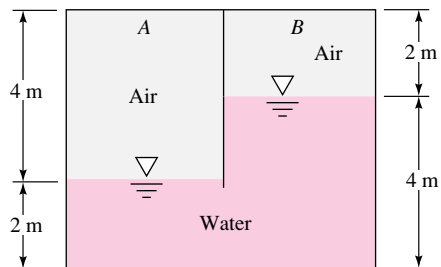

P2.14

- P2.15** The air–oil–water system in Fig. P2.15 is at 20°C. Knowing that gage A reads 15 lbf/in^2 absolute and gage B reads 1.25 lbf/in^2 less than gage C , compute (a) the

specific weight of the oil in lbf/ft^3 and (b) the actual reading of gage C in lbf/in^2 absolute.

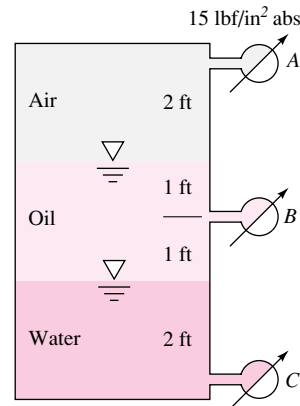

P2.15

- P2.16** Suppose one wishes to construct a barometer using ethanol at 20°C (Table A.3) as the working fluid. Account for the equilibrium vapor pressure in your calculations and determine how high such a barometer should be. Compare this with the traditional mercury barometer.

- P2.17** The system in Fig. P2.17 is at 20°C. If the pressure at point A is 1900 lbf/ft^2 , determine the pressures at points B , C , and D in lbf/ft^2 .

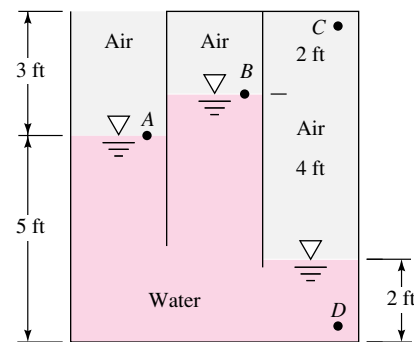

P2.17

- P2.18** The system in Fig. P2.18 is at 20°C. If atmospheric pressure is 101.33 kPa and the pressure at the bottom of the tank is 242 kPa , what is the specific gravity of fluid X ?

- P2.19** The U-tube in Fig. P2.19 has a 1-cm ID and contains mercury as shown. If 20 cm^3 of water is poured into the right-hand leg, what will the free-surface height in each leg be after the sloshing has died down?

- P2.20** The hydraulic jack in Fig. P2.20 is filled with oil at 56 lbf/ft^3 . Neglecting the weight of the two pistons, what force F on the handle is required to support the 2000-lbf weight for this design?

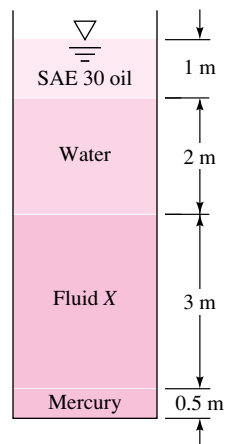

P2.18

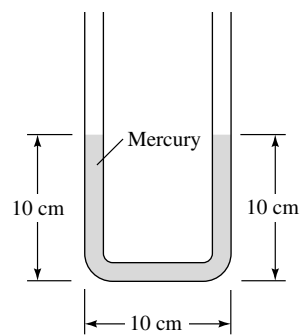

P2.19

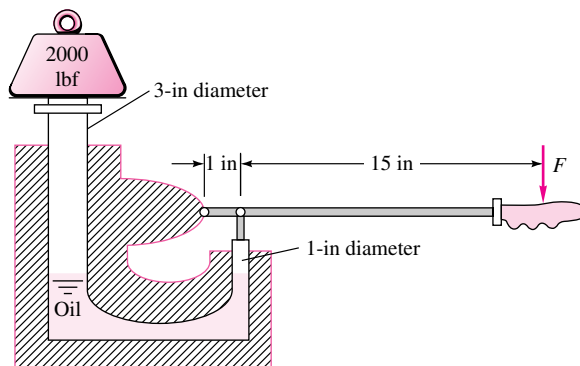

P2.20

P2.21 At 20°C gage *A* reads 350 kPa absolute. What is the height h of the water in cm? What should gage *B* read in kPa absolute? See Fig. P2.21.

P2.22 The fuel gage for a gasoline tank in a car reads proportional to the bottom gage pressure as in Fig. P2.22. If the tank is 30 cm deep and accidentally contains 2 cm of water plus gasoline, how many centimeters of air remain at the top when the gage erroneously reads “full”?

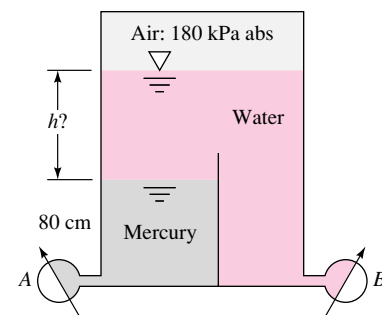

P2.21

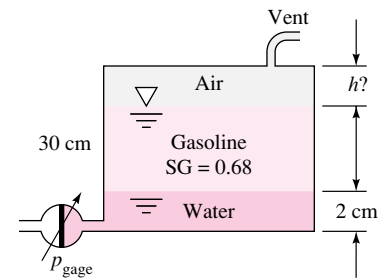

P2.22

P2.23 In Fig. P2.23 both fluids are at 20°C. If surface tension effects are negligible, what is the density of the oil, in kg/m^3 ?

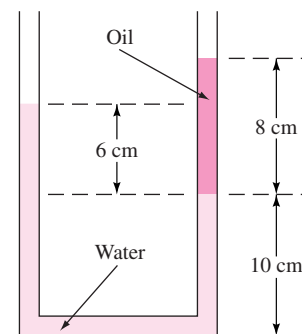

P2.23

P2.24 In Prob. 1.2 we made a crude integration of the density distribution $\rho(z)$ in Table A.6 and estimated the mass of the earth's atmosphere to be $m \approx 6 \text{ E}18 \text{ kg}$. Can this result be used to estimate sea-level pressure on the earth? Conversely, can the actual sea-level pressure of 101.35 kPa be used to make a more accurate estimate of the atmospheric mass?

P2.25 Venus has a mass of 4.90 E24 kg and a radius of 6050 km. Its atmosphere is 96 percent CO_2 , but let us assume it to be 100 percent. Its surface temperature averages 730 K, decreasing to 250 K at an altitude of 70 km. The average surface pressure is 9.1 MPa. Estimate the atmospheric pressure of Venus at an altitude of 5 km.

110 Chapter 2 Pressure Distribution in a Fluid

- *P2.26** A *polytropic atmosphere* is defined by the power law $p/p_0 = (\rho/\rho_0)^m$, where m is an exponent of order 1.3 and p_0 and ρ_0 are sea-level values of pressure and density. (a) Integrate this expression in the static atmosphere and find a distribution $p(z)$. (b) Assuming an ideal gas, $p = \rho RT$, show that your result in (a) implies a linear temperature distribution as in Eq. (2.25). (c) Show that the standard value $B = 0.0065$ K/m is equivalent to $m = 1.235$.

- P2.27** Conduct an experiment to illustrate atmospheric pressure. *Note:* Do this over a sink or you may get wet! Find a drinking glass with a very smooth, uniform rim at the top. Fill the glass nearly full with water. Place a smooth, light, flat plate on top of the glass such that the entire rim of the glass is covered. A glossy postcard works best. A small index card or one flap of a greeting card will also work. See Fig. P2.27a.

(a) Hold the card against the rim of the glass and turn the glass upside down. Slowly release pressure on the card. Does the water fall out of the glass? Record your experimental observations. (b) Find an expression for the pressure at points 1 and 2 in Fig. P2.27b. Note that the glass is now inverted, so the original top rim of the glass is at the bottom of the picture, and the original bottom of the glass is at the top of the picture. The weight of the card can be neglected. (c) Estimate the theoretical maximum glass height at which this experiment could still work, such that the water would not fall out of the glass.

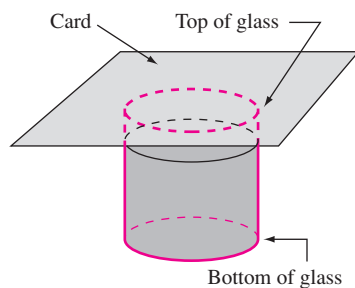

P2.27a

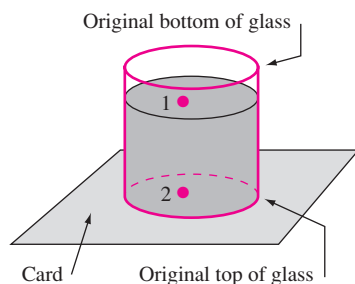

P2.27b

- P2.28** What is the uncertainty in using pressure measurement as an altimeter? A gage on an airplane measures a local

pressure of 54 kPa with an uncertainty of 3 kPa. The lapse rate is 0.006 K/m with an uncertainty of 0.001 K/m. Effective sea-level temperature is 10°C with an uncertainty of 5°C. Effective sea-level pressure is 100 kPa with an uncertainty of 2 kPa. Estimate the plane's altitude and its uncertainty.

- *P2.29** Under some conditions the atmosphere is *adiabatic*, $p \approx (\text{const})(\rho^k)$, where k is the specific heat ratio. Show that, for an adiabatic atmosphere, the pressure variation is given by

$$p = p_0 \left[1 - \frac{(k-1)gz}{kRT_0} \right]^{k/(k-1)}$$

Compare this formula for air at $z = 5000$ m with the standard atmosphere in Table A.6.

- P2.30** A mercury manometer is connected at two points to a horizontal 20°C water-pipe flow. If the manometer reading is $h = 35$ cm, what is the pressure drop between the two points?

- P2.31** In Fig. P2.31 all fluids are at 20°C. Determine the pressure difference (Pa) between points A and B.

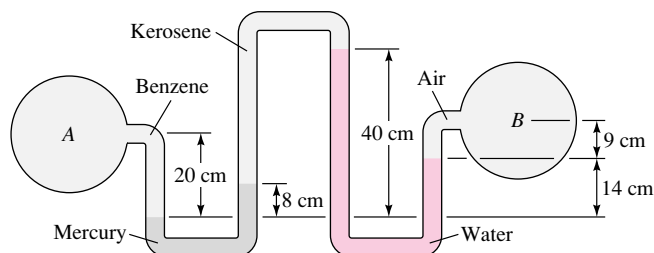

P2.31

- P2.32** For the inverted manometer of Fig. P2.32, all fluids are at 20°C. If $p_B - p_A = 97$ kPa, what must the height H be in cm?

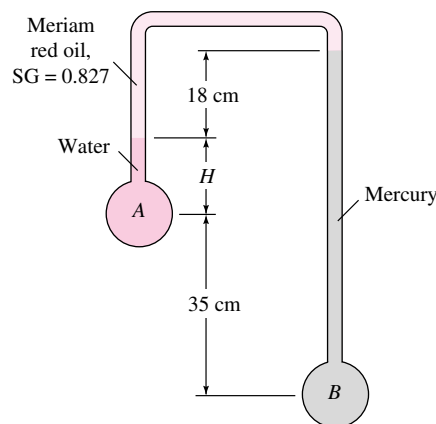

P2.32

- P2.33** In Fig. P2.33 the pressure at point *A* is 25 lbf/in². All fluids are at 20°C. What is the air pressure in the closed chamber *B*, in Pa?

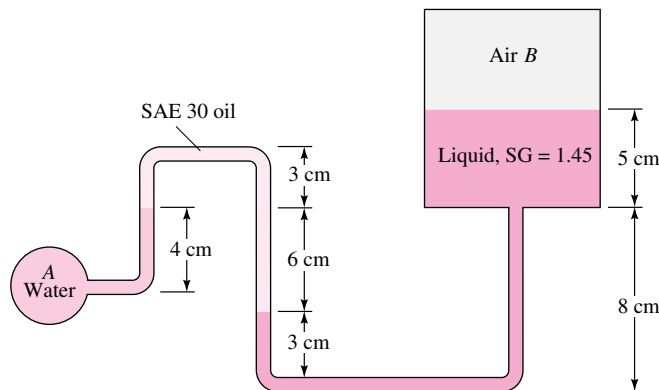

P2.33

- *P2.34** Sometimes manometer dimensions have a significant effect. In Fig. P2.34 containers (*a*) and (*b*) are cylindrical and conditions are such that $p_a = p_b$. Derive a formula for the pressure difference $p_a - p_b$ when the oil–water interface on the right rises a distance $\Delta h < h$, for (*a*) $d \ll D$ and (*b*) $d = 0.15D$. What is the percentage change in the value of Δp ?

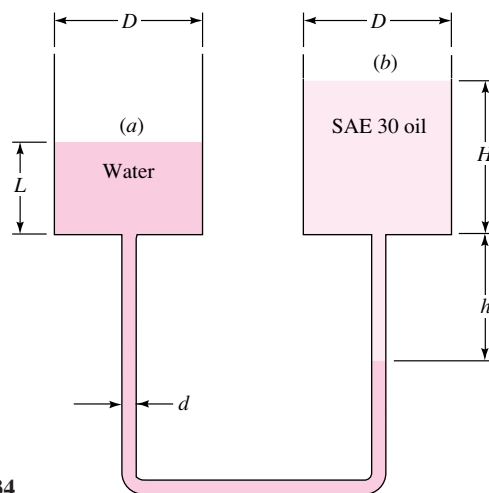

P2.34

- P2.35** Water flows upward in a pipe slanted at 30°, as in Fig. P2.35. The mercury manometer reads $h = 12$ cm. Both fluids are at 20°C. What is the pressure difference $p_1 - p_2$ in the pipe?
- P2.36** In Fig. P2.36 both the tank and the tube are open to the atmosphere. If $L = 2.13$ m, what is the angle of tilt θ of the tube?

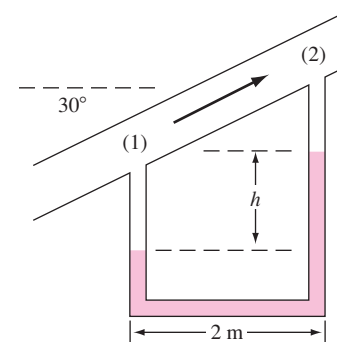

P2.35

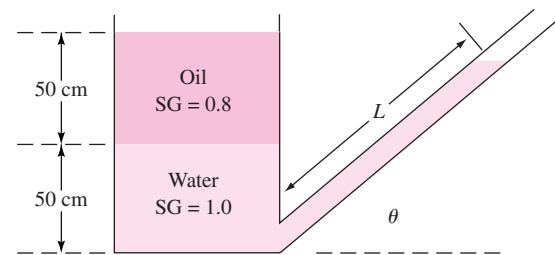

P2.36

- P2.37** The inclined manometer in Fig. P2.37 contains Meriam red manometer oil, $SG = 0.827$. Assume that the reservoir is very large. If the inclined arm is fitted with graduations 1 in apart, what should the angle θ be if each graduation corresponds to 1 lbf/ft² gage pressure for p_A ?

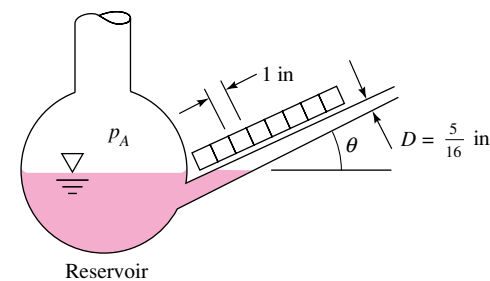

P2.37

- P2.38** An interesting article appeared in the *AIAA Journal* (vol. 30, no. 1, January 1992, pp. 279–280). The authors explain that the air inside fresh plastic tubing can be up to 25 percent more dense than that of the surroundings, due to outgassing or other contaminants introduced at the time of manufacture. Most researchers, however, assume that the tubing is filled with room air at standard air density, which can lead to significant errors when using this kind of tubing to measure pressures. To illustrate this, consider a U-tube

112 Chapter 2 Pressure Distribution in a Fluid

manometer with manometer fluid ρ_m . One side of the manometer is open to the air, while the other is connected to new tubing that extends to pressure measurement location 1, some height H higher in elevation than the surface of the manometer liquid. For consistency, let ρ_a be the density of the air in the room, ρ_t be the density of the gas inside the tube, ρ_m be the density of the manometer liquid, and h be the height difference between the two sides of the manometer. See Fig. P2.38. (a) Find an expression for the gage pressure at the measurement point. *Note:* When calculating gage pressure, use the local atmospheric pressure at the elevation of the measurement point. You may assume that $h \ll H$; that is, assume the gas in the entire left side of the manometer is of density ρ_t . (b) Write an expression for the error caused by assuming that the gas inside the tubing has the same density as that of the surrounding air. (c) How much error (in Pa) is caused by ignoring this density difference for the following conditions: $\rho_m = 860 \text{ kg/m}^3$, $\rho_a = 1.20 \text{ kg/m}^3$, $\rho_t = 1.50 \text{ kg/m}^3$, $H = 1.32 \text{ m}$, and $h = 0.58 \text{ cm}$? (d) Can you think of a simple way to avoid this error?

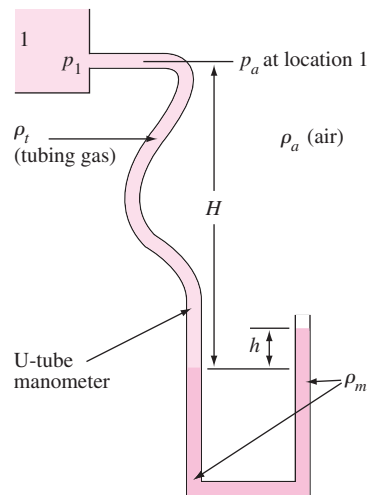

P2.38

- P2.39** In Fig. P2.39 the right leg of the manometer is open to the atmosphere. Find the gage pressure, in Pa, in the air gap in the tank.
- P2.40** In Fig. P2.40 the pressures at A and B are the same, 100 kPa. If water is introduced at A to increase p_A to 130 kPa, find and sketch the new positions of the mercury menisci. The connecting tube is a uniform 1-cm diameter. Assume no change in the liquid densities.
- P2.41** The system in Fig. P2.41 is at 20°C. Compute the pressure at point A in lbf/ft² absolute.

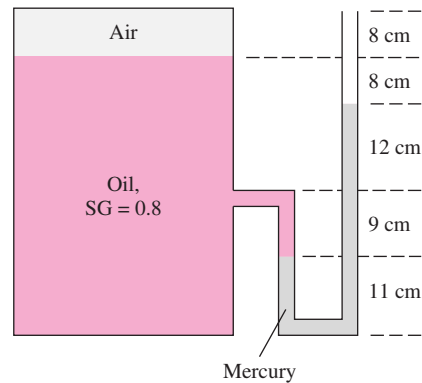

P2.39

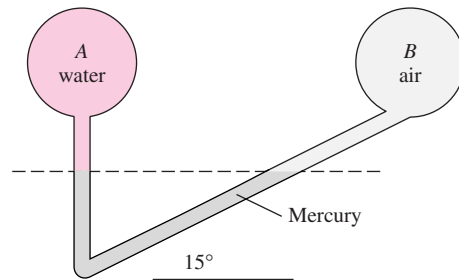

P2.40

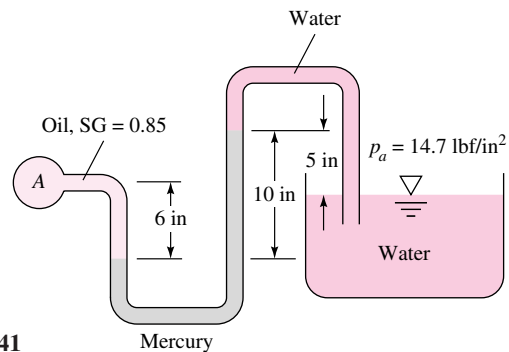

P2.41

- P2.42** Very small pressure differences $p_A - p_B$ can be measured accurately by the two-fluid differential manometer in Fig. P2.42. Density ρ_2 is only slightly larger than that of the upper fluid ρ_1 . Derive an expression for the proportionality between h and $p_A - p_B$ if the reservoirs are very large.
- P2.43** The traditional method of measuring blood pressure uses a *sphygmomanometer*, first recording the highest (*systolic*) and then the lowest (*diastolic*) pressure from which flowing “Korotkoff” sounds can be heard. Patients with dangerous hypertension can exhibit systolic pressures as high as 5 lbf/in². Normal levels, however, are 2.7 and 1.7 lbf/in², respectively, for systolic and diastolic pressures. The manometer uses mercury and air as fluids.

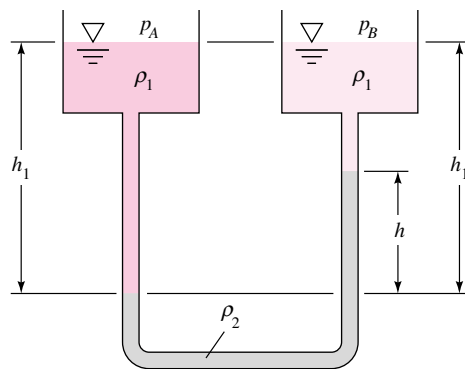
**P2.42**

- (a) How high in cm should the manometer tube be?
 (b) Express normal systolic and diastolic blood pressure in millimeters of mercury.

- P2.44** Water flows downward in a pipe at 45° , as shown in Fig. P2.44. The pressure drop $p_1 - p_2$ is partly due to gravity and partly due to friction. The mercury manometer reads a 6-in height difference. What is the total pressure drop $p_1 - p_2$ in lbf/in^2 ? What is the pressure drop due to friction only between 1 and 2 in lbf/in^2 ? Does the manometer reading correspond only to friction drop? Why?

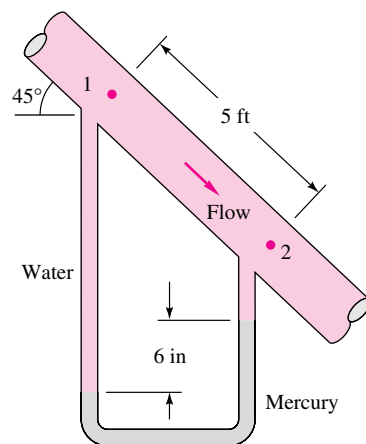
**P2.44**

- P2.45** In Fig. P2.45, determine the gage pressure at point A in Pa. Is it higher or lower than atmospheric?
P2.46 In Fig. P2.46 both ends of the manometer are open to the atmosphere. Estimate the specific gravity of fluid X.
P2.47 The cylindrical tank in Fig. P2.47 is being filled with water at 20°C by a pump developing an exit pressure of 175 kPa. At the instant shown, the air pressure is 110 kPa and $H = 35$ cm. The pump stops when it can no longer raise the water pressure. For isothermal air compression, estimate H at that time.

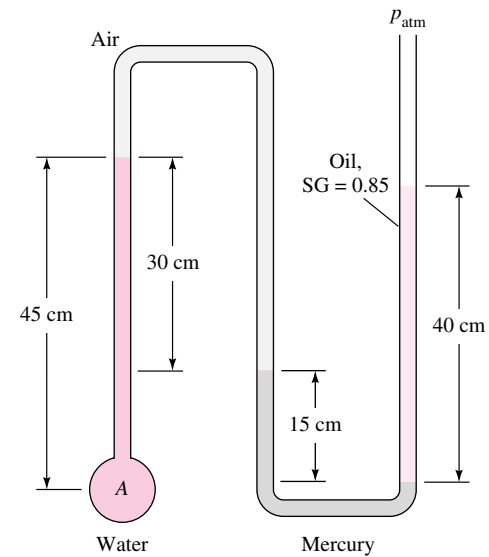
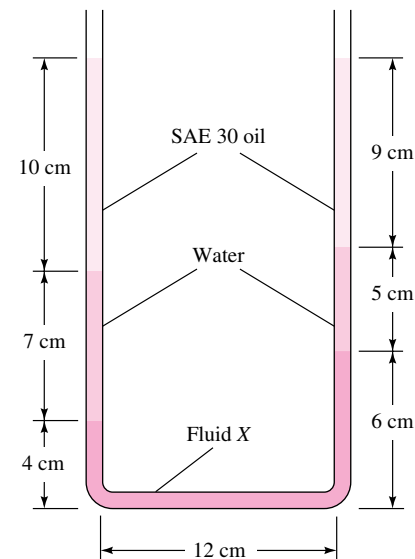
**P2.45****P2.46**

- P2.48** Conduct the following experiment to illustrate air pressure. Find a thin wooden ruler (approximately 1 ft in length) or a thin wooden paint stirrer. Place it on the edge of a desk or table with a little less than half of it hanging over the edge lengthwise. Get two full-size sheets of newspaper; open them up and place them on top of the ruler, covering only the portion of the ruler resting on the desk as illustrated in Fig. P2.48. (a) Estimate the total force on top of the newspaper due to air pressure in the room. (b) *Careful!* To avoid potential injury, make sure nobody is standing directly in front of

114 Chapter 2 Pressure Distribution in a Fluid

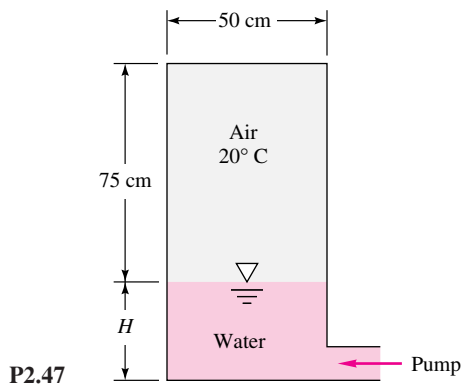

P2.47

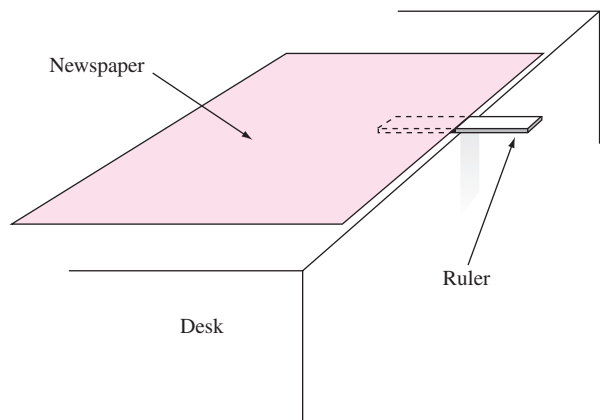

P2.48

the desk. Perform a karate chop on the portion of the ruler sticking out over the edge of the desk. Record your results. (c) Explain your results.

- P2.49** An inclined manometer, similar in concept to Fig. P2.37, has a vertical cylinder reservoir whose cross-sectional area is 35 times that of the tube. The fluid is ethylene glycol at 20°C . If $\theta = 20^\circ$ and the fluid rises 25 cm above its zero-difference level, measured along the slanted tube, what is the actual pressure difference being measured?
- P2.50** A vat filled with oil ($\text{SG} = 0.85$) is 7 m long and 3 m deep and has a trapezoidal cross section 2 m wide at the bottom and 4 m wide at the top. Compute (a) the weight of oil in the vat, (b) the force on the vat bottom, and (c) the force on the trapezoidal end panel.
- P2.51** Gate AB in Fig. P2.51 is 1.2 m long and 0.8 m into the paper. Neglecting atmospheric pressure, compute the force F on the gate and its center-of-pressure position X .
- P2.52** A vertical lock gate is 4 m wide and separates 20°C water levels of 2 m and 3 m, respectively. Find the moment about the bottom required to keep the gate stationary.

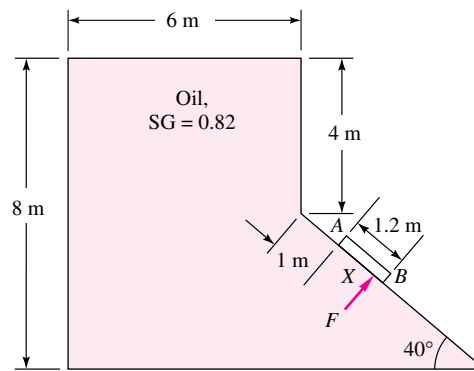

P2.51

- P2.53** Panel ABC in the slanted side of a water tank is an isosceles triangle with the vertex at A and the base $BC = 2$ m, as in Fig. P2.53. Find the water force on the panel and its line of action.

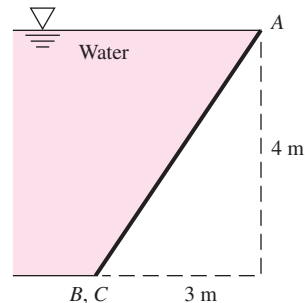

P2.53

- P2.54** In Fig. P2.54, the hydrostatic force F is the same on the bottom of all three containers, even though the weights of liquid above are different. The three bottom shapes and the fluids are the same. This is called the *hydrostatic paradox*. Explain why it is true and sketch a free body of each of the liquid columns.

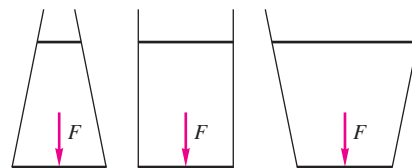

P2.54

- P2.55** Gate AB in Fig. P2.55 is 5 ft wide into the paper, hinged at A , and restrained by a stop at B . The water is at 20°C . Compute (a) the force on stop B and (b) the reactions at A if the water depth $h = 9.5$ ft.
- P2.56** In Fig. P2.55, gate AB is 5 ft wide into the paper, and stop B will break if the water force on it equals 9200 lbf. For what water depth h is this condition reached?

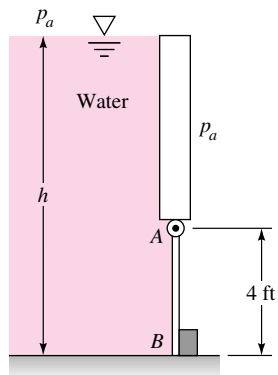

P2.55

P2.57 The tank in Fig. P2.57 is 2 m wide into the paper. Neglecting atmospheric pressure, find the resultant hydrostatic force on panel *BC* (*a*) from a single formula and (*b*) by computing horizontal and vertical forces separately, in the spirit of Section 2.6.

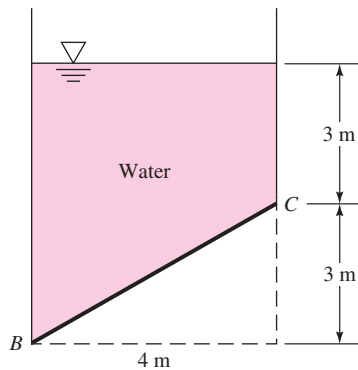

P2.57

P2.58 In Fig. P2.58, the cover gate *AB* closes a circular opening 80 cm in diameter. The gate is held closed by a 200-kg mass as shown. Assume standard gravity at 20°C. At what water level *h* will the gate be dislodged? Neglect the weight of the gate.

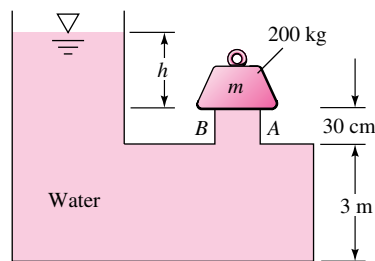

P2.58

***P2.59** Gate *AB* has length *L* and width *b* into the paper, is hinged at *B*, and has negligible weight. The liquid level *h* remains at the top of the gate for any angle θ . Find

an analytic expression for the force *P*, perpendicular to *AB*, required to keep the gate in equilibrium in Fig. P2.59.

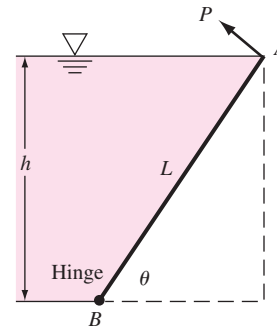

P2.59

P2.60 The pressure in the air gap in Fig. P2.60 is 8000 Pa gage. The tank is cylindrical. Calculate the net hydrostatic force (*a*) on the bottom of the tank, (*b*) on the cylindrical sidewall *CC*, and (*c*) on the annular plane panel *BB*.

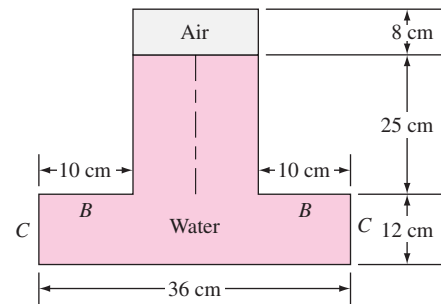

P2.60

***P2.61** Gate *AB* in Fig. P2.61 is a homogeneous mass of 180 kg, 1.2 m wide into the paper, hinged at *A*, and resting on a smooth bottom at *B*. All fluids are at 20°C. For what water depth *h* will the force at point *B* be zero?

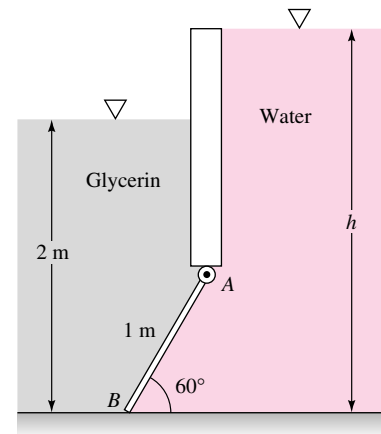

P2.61

116 Chapter 2 Pressure Distribution in a Fluid

- P2.62** Gate AB in Fig. P2.62 is 15 ft long and 8 ft wide into the paper and is hinged at B with a stop at A . The water is at 20°C . The gate is 1-in-thick steel, $\text{SG} = 7.85$. Compute the water level h for which the gate will start to fall.

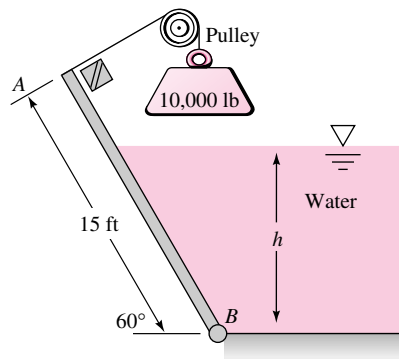

P2.62

- P2.63** The tank in Fig. P2.63 has a 4-cm-diameter plug at the bottom on the right. All fluids are at 20°C . The plug will pop out if the hydrostatic force on it is 25 N. For this condition, what will be the reading h on the mercury manometer on the left side?

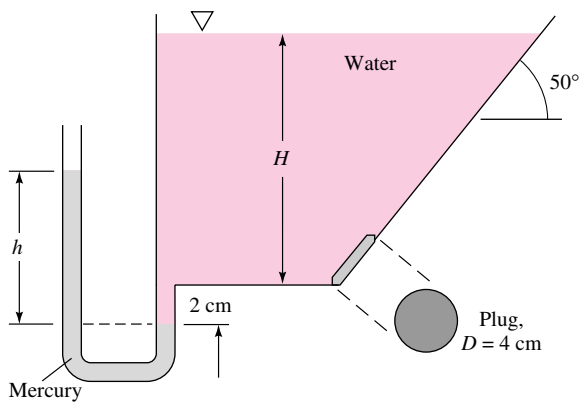

P2.63

- *P2.64** Gate ABC in Fig. P2.64 has a fixed hinge line at B and is 2 m wide into the paper. The gate will open at A to release water if the water depth is high enough. Compute the depth h for which the gate will begin to open.
- *P2.65** Gate AB in Fig. P2.65 is semicircular, hinged at B , and held by a horizontal force P at A . What force P is required for equilibrium?
- P2.66** Dam ABC in Fig. P2.66 is 30 m wide into the paper and made of concrete ($\text{SG} = 2.4$). Find the hydrostatic force on surface AB and its moment about C . Assuming no seepage of water under the dam, could this force tip the

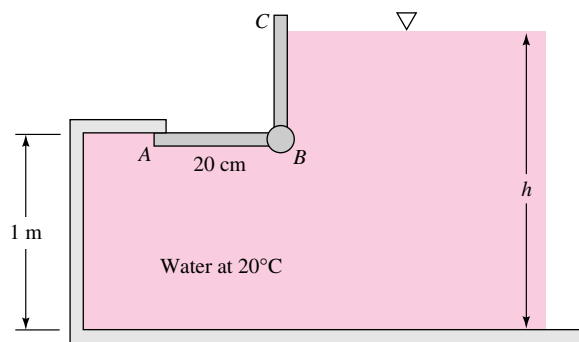

P2.64

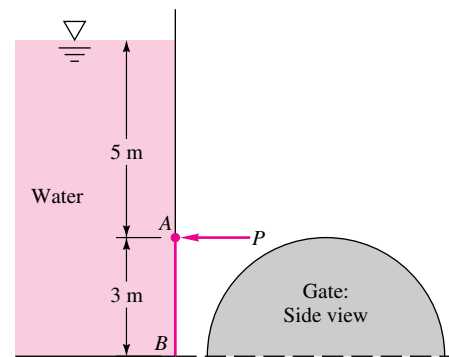

P2.65

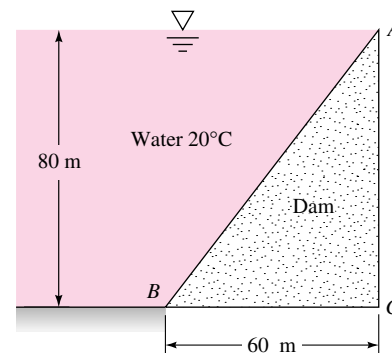

P2.66

dam over? How does your argument change if there is seepage under the dam?

- *P2.67** Generalize Prob. 2.66 as follows. Denote length AB as H , length BC as L , and angle ABC as θ . Let the dam material have specific gravity SG . The width of the dam is b . Assume no seepage of water under the dam. Find an analytic relation between SG and the critical angle θ_c for which the dam will just tip over to the right. Use your relation to compute θ_c for the special case $\text{SG} = 2.4$ (concrete).

- P2.68** Isosceles triangle gate AB in Fig. P2.68 is hinged at A and weighs 1500 N. What horizontal force P is required at point B for equilibrium?

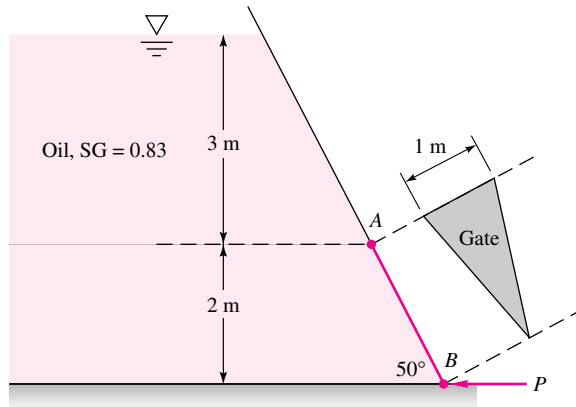

P2.68

- P2.69** Panel BCD in Fig. P2.69 is semicircular and line BC is 8 cm below the surface. Determine (a) the hydrostatic force on the panel and (b) the moment of this force about D .

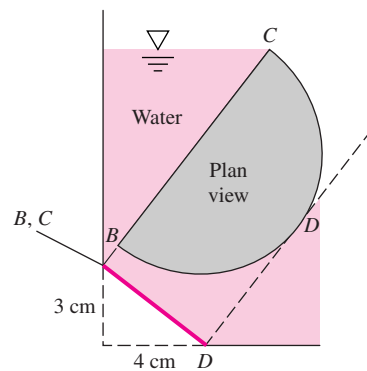

P2.69

- P2.70** The cylindrical tank in Fig. P2.70 has a 35-cm-high cylindrical insert in the bottom. The pressure at point B is 156 kPa. Find (a) the pressure in the air space and (b) the force F on top of the insert. Neglect air pressure outside the tank.

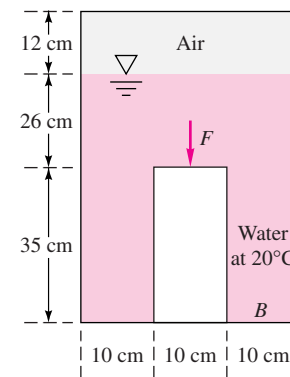

P2.70

- *P2.71** In Fig. P2.71 gate AB is 3 m wide into the paper and is connected by a rod and pulley to a concrete sphere ($SG = 2.40$). What diameter of the sphere is just sufficient to keep the gate closed?

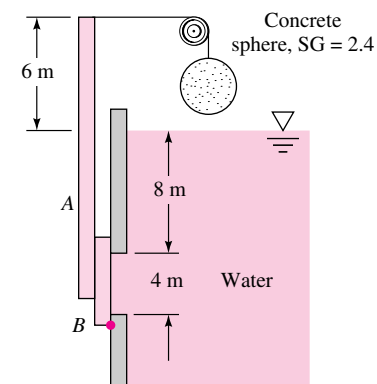

P2.71

- P2.72** Gate B in Fig. P2.72 is 30 cm high, 60 cm wide into the paper, and hinged at the top. What water depth h will first cause the gate to open?

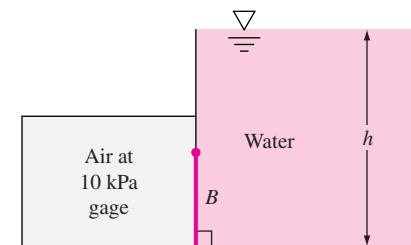

P2.72

- P2.73** Gate AB is 5 ft wide into the paper and opens to let fresh water out when the ocean tide is dropping. The hinge at A is 2 ft above the freshwater level. At what ocean level h will the gate first open? Neglect the gate weight.

- P2.74** Find the height H in Fig. P2.74 for which the hydrostatic force on the rectangular panel is the same as the force on the semicircular panel below.

- *P2.75** Gate AB in Fig. P2.75 is hinged at A , has width b into the paper, and makes smooth contact at B . The gate has density ρ_s and uniform thickness t . For what gate density ρ_s , expressed as a function of (h, t, ρ, θ) , will the gate just begin to lift off the bottom? Why is your answer independent of gate length L and width b ?

118 Chapter 2 Pressure Distribution in a Fluid

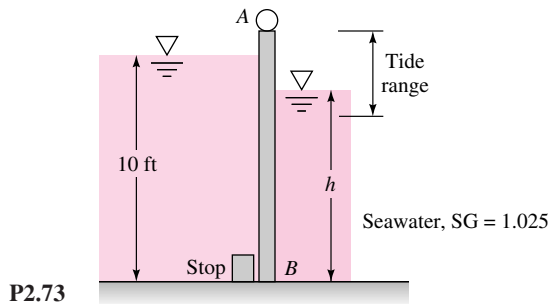

P2.73

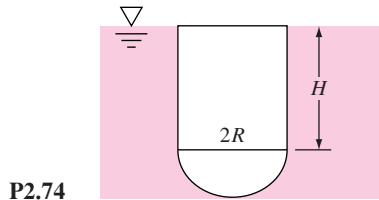

P2.74

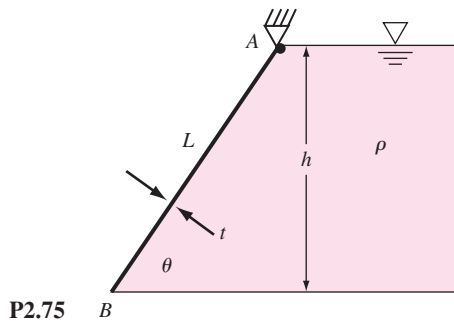

P2.75

P2.76 Panel BC in Fig. P2.76 is circular. Compute (a) the hydrostatic force of the water on the panel, (b) its center of pressure, and (c) the moment of this force about point B.

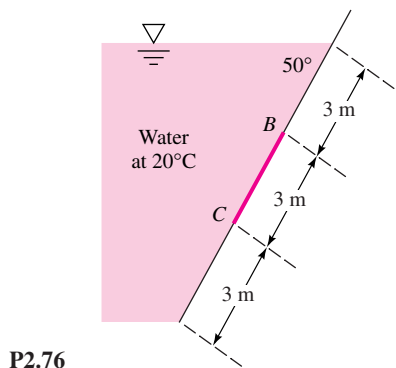

P2.76

P2.77 The circular gate ABC in Fig. P2.77 has a 1-m radius and is hinged at B. Compute the force P just sufficient

to keep the gate from opening when $h = 8$ m. Neglect atmospheric pressure.

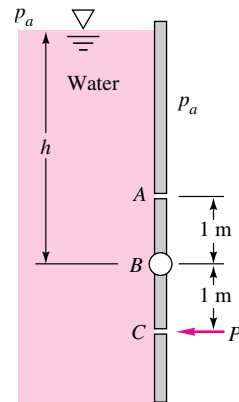

P2.77

P2.78 Repeat Prob. 2.77 to derive an analytic expression for P as a function of h. Is there anything unusual about your solution?

P2.79 Gate ABC in Fig. P2.79 is 1 m square and is hinged at B. It will open automatically when the water level h becomes high enough. Determine the lowest height for which the gate will open. Neglect atmospheric pressure. Is this result independent of the liquid density?

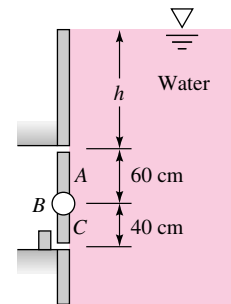

P2.79

P2.80 For the closed tank in Fig. P2.80, all fluids are at 20°C, and the airspace is pressurized. It is found that the net outward hydrostatic force on the 30-by-40-cm panel at the bottom of the water layer is 8450 N. Estimate (a) the pressure in the airspace and (b) the reading h on the mercury manometer.

P2.81 Gate AB in Fig. P2.81 is 7 ft into the paper and weighs 3000 lbf when submerged. It is hinged at B and rests against a smooth wall at A. Determine the water level h at the left that will just cause the gate to open.

*P2.82 The dam in Fig. P2.82 is a quarter circle 50 m wide into the paper. Determine the horizontal and vertical

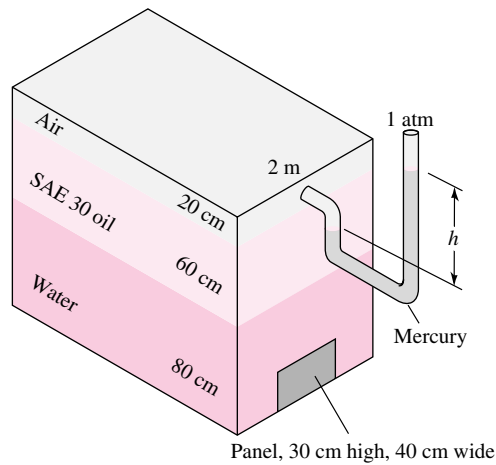

P2.80

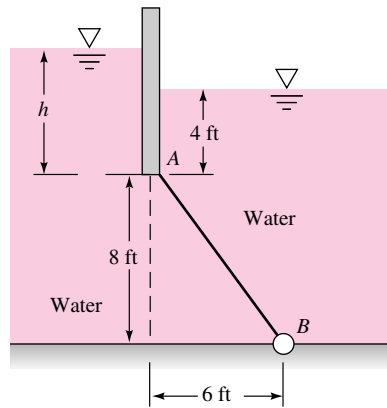

P2.81

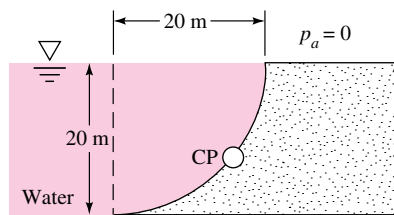

P2.82

components of the hydrostatic force against the dam and the point CP where the resultant strikes the dam.

***P2.83** Gate AB in Fig. P2.83 is a quarter circle 10 ft wide into the paper and hinged at B . Find the force F just sufficient to keep the gate from opening. The gate is uniform and weighs 3000 lbf.

P2.84 Determine (a) the total hydrostatic force on the curved surface AB in Fig. P2.84 and (b) its line of action. Neglect atmospheric pressure, and let the surface have unit width.

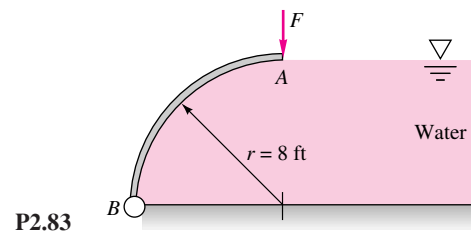

P2.83

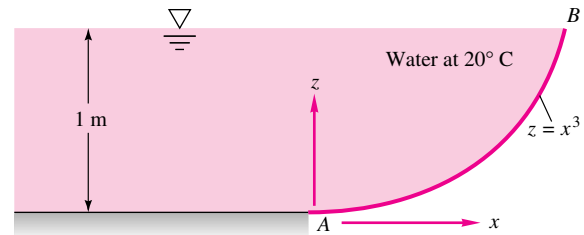

P2.84

P2.85 Compute the horizontal and vertical components of the hydrostatic force on the quarter-circle panel at the bottom of the water tank in Fig. P2.85.

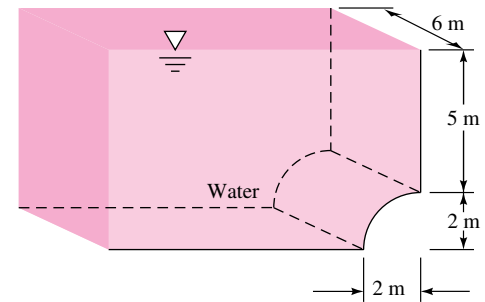

P2.85

P2.86 The quarter circle gate BC in Fig. P2.86 is hinged at C . Find the horizontal force P required to hold the gate stationary.

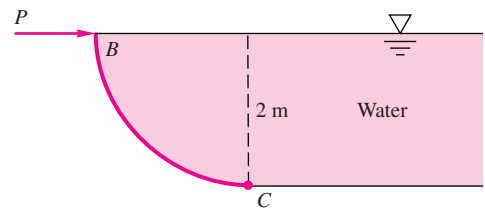

P2.86

P2.87 The bottle of champagne ($SG = 0.96$) in Fig. P2.87 is under pressure, as shown by the mercury-manometer reading. Compute the net force on the 2-in-radius hemispherical end cap at the bottom of the bottle.

120 Chapter 2 Pressure Distribution in a Fluid

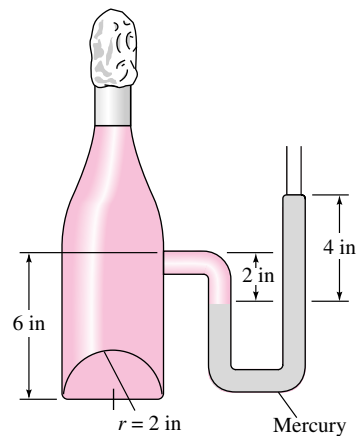

P2.87

- *P2.88** Gate ABC is a circular arc, sometimes called a *Tainter gate*, which can be raised and lowered by pivoting about point O . See Fig. P2.88. For the position shown, determine (a) the hydrostatic force of the water on the gate and (b) its line of action. Does the force pass through point O ?

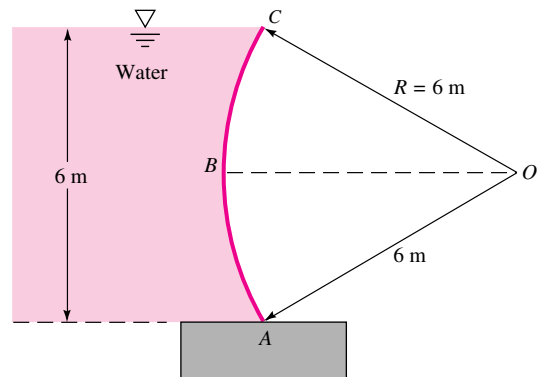

P2.88

- P2.89** The tank in Fig. P2.89 contains benzene and is pressurized to 200 kPa (gage) in the air gap. Determine the vertical hydrostatic force on circular-arc section AB and its line of action.
- P2.90** A 1-ft-diameter hole in the bottom of the tank in Fig. P2.90 is closed by a conical 45° plug. Neglecting the weight of the plug, compute the force F required to keep the plug in the hole.
- P2.91** The hemispherical dome in Fig. P2.91 weighs 30 kN and is filled with water and attached to the floor by six equally spaced bolts. What is the force in each bolt required to hold down the dome?
- P2.92** A 4-m-diameter water tank consists of two half cylinders, each weighing 4.5 kN/m, bolted together as shown

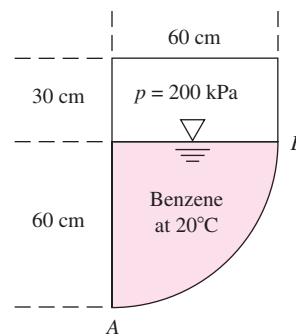

P2.89

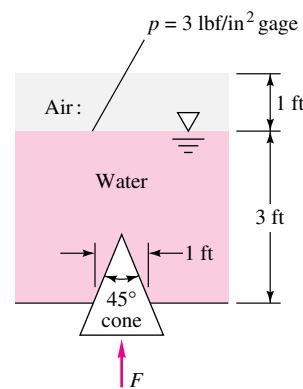

P2.90

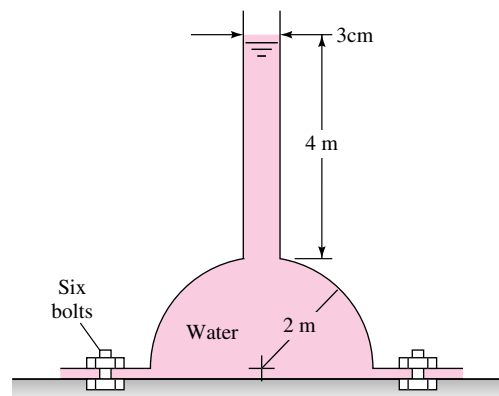

P2.91

in Fig. P2.92. If the support of the end caps is neglected, determine the force induced in each bolt.

- *P2.93** In Fig. P2.93, a one-quadrant spherical shell of radius R is submerged in liquid of specific weight γ and depth $h > R$. Find an analytic expression for the resultant hydrostatic force, and its line of action, on the shell surface.

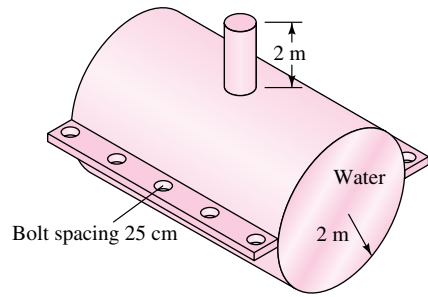

P2.92

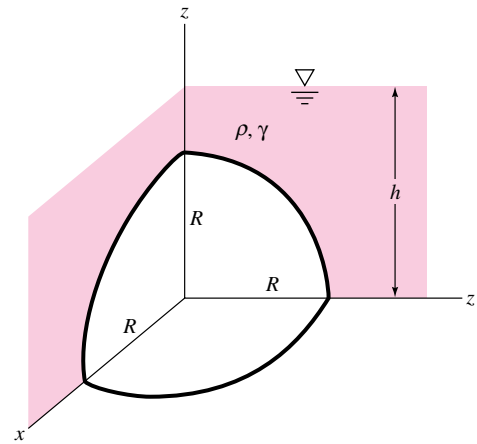

P2.93

P2.94 The 4-ft-diameter log (SG = 0.80) in Fig. P2.94 is 8 ft long into the paper and dams water as shown. Compute the net vertical and horizontal reactions at point C.

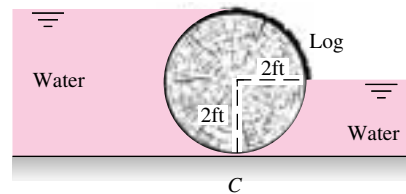

P2.94

***P2.95** The uniform body A in Fig. P2.95 has width b into the paper and is in static equilibrium when pivoted about hinge O . What is the specific gravity of this body if (a) $h = 0$ and (b) $h = R$?

P2.96 Curved panel BC in Fig. P2.96 is a 60° arc, perpendicular to the bottom at C . If the panel is 4 m wide into the paper, estimate the resultant hydrostatic force of the water on the panel.

P2.97 Gate AB in Fig. P2.97 is a three-eighths circle, 3 m wide into the paper, hinged at B , and resting against a smooth wall at A . Compute the reaction forces at points A and B .

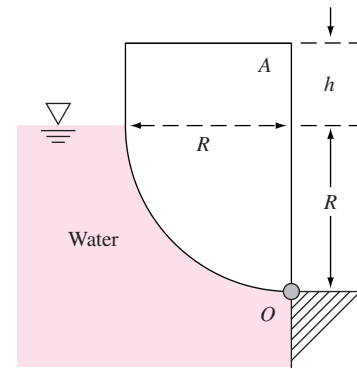

P2.95

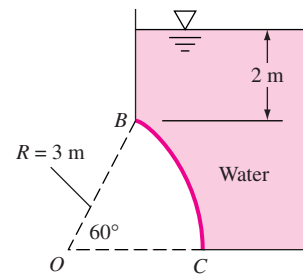

P2.96

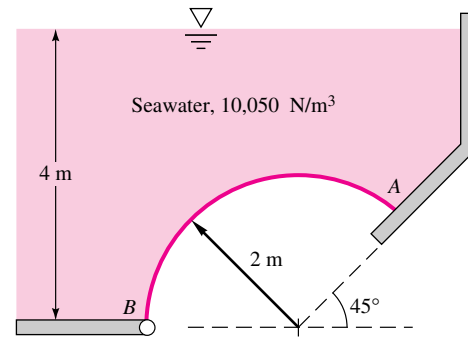

P2.97

P2.98 Gate ABC in Fig. P2.98 is a quarter circle 8 ft wide into the paper. Compute the horizontal and vertical hydrostatic forces on the gate and the line of action of the resultant force.

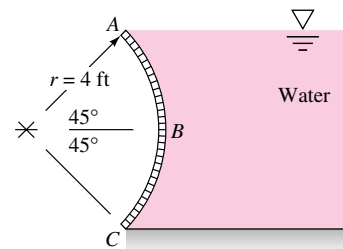

P2.98

122 Chapter 2 Pressure Distribution in a Fluid

- P2.99** A 2-ft-diameter sphere weighing 400 lbf closes a 1-ft-diameter hole in the bottom of the tank in Fig. P2.99. Compute the force F required to dislodge the sphere from the hole.

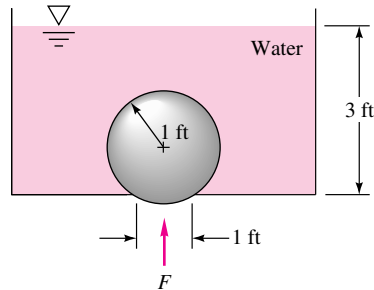

P2.99

- P2.100** Pressurized water fills the tank in Fig. P2.100. Compute the net hydrostatic force on the conical surface ABC .

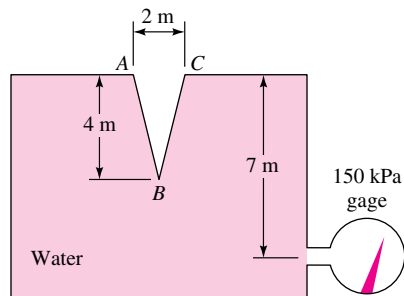

P2.100

- P2.101** A fuel truck has a tank cross section that is approximately elliptical, with a 3-m horizontal major axis and a 2-m vertical minor axis. The top is vented to the atmosphere. If the tank is filled half with water and half with gasoline, what is the hydrostatic force on the flat elliptical end panel?
- P2.102** A cubical tank is $3 \times 3 \times 3$ m and is layered with 1 meter of fluid of specific gravity 1.0, 1 meter of fluid with $SG = 0.9$, and 1 meter of fluid with $SG = 0.8$. Neglect atmospheric pressure. Find (a) the hydrostatic force on the bottom and (b) the force on a side panel.
- P2.103** A solid block, of specific gravity 0.9, floats such that 75 percent of its volume is in water and 25 percent of its volume is in fluid X , which is layered above the water. What is the specific gravity of fluid X ?
- P2.104** The can in Fig. P2.104 floats in the position shown. What is its weight in N?
- P2.105** It is said that Archimedes discovered the buoyancy laws when asked by King Hiero of Syracuse to determine whether his new crown was pure gold ($SG = 19.3$). Archimedes measured the weight of the crown in air to

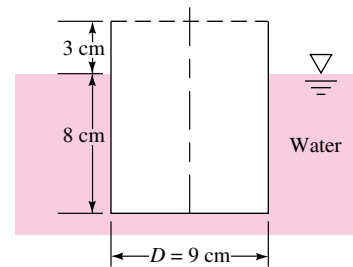

P2.104

be 11.8 N and its weight in water to be 10.9 N. Was it pure gold?

- P2.106** A spherical helium balloon is 2.5 m in diameter and has a total mass of 6.7 kg. When released into the U.S. standard atmosphere, at what altitude will it settle?
- P2.107** Repeat Prob. 2.62, assuming that the 10,000-lbf weight is aluminum ($SG = 2.71$) and is hanging submerged in the water.
- P2.108** A piece of yellow pine wood ($SG = 0.65$) is 5 cm square and 2.2 m long. How many newtons of lead ($SG = 11.4$) should be attached to one end of the wood so that it will float vertically with 30 cm out of the water?
- P2.109** A hydrometer floats at a level that is a measure of the specific gravity of the liquid. The stem is of constant diameter D , and a weight in the bottom stabilizes the body to float vertically, as shown in Fig. P2.109. If the position $h = 0$ is pure water ($SG = 1.0$), derive a formula for h as a function of total weight W , D , SG , and the specific weight γ_0 of water.

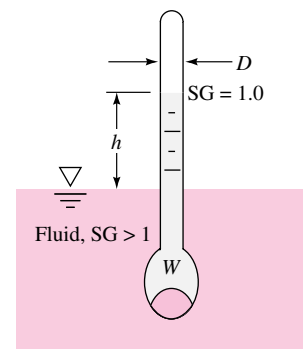

P2.109

- P2.110** An average table tennis ball has a diameter of 3.81 cm and a mass of 2.6 g. Estimate the (small) depth at which this ball will float in water at 20°C and sea-level standard air if air buoyancy is (a) neglected and (b) included.
- P2.111** A hot-air balloon must be designed to support basket, cords, and one person for a total weight of 1300 N. The balloon material has a mass of 60 g/m². Ambient air is

- at 25°C and 1 atm. The hot air inside the balloon is at 70°C and 1 atm. What diameter spherical balloon will just support the total weight? Neglect the size of the hot-air inlet vent.
- P2.112** The uniform 5-m-long round wooden rod in Fig. P2.112 is tied to the bottom by a string. Determine (a) the tension in the string and (b) the specific gravity of the wood. Is it possible for the given information to determine the inclination angle θ ? Explain.

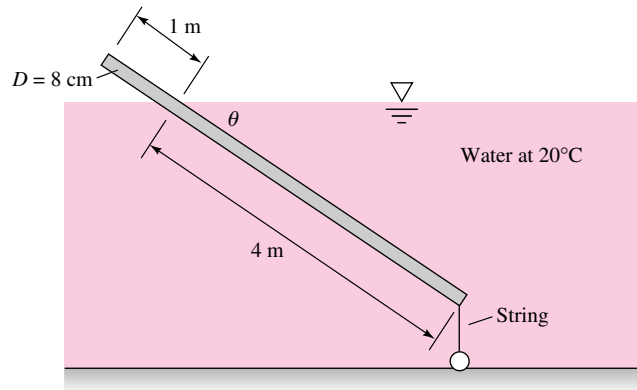

P2.112

- P2.113** A spar buoy is a buoyant rod weighted to float and protrude vertically, as in Fig. P2.113. It can be used for measurements or markers. Suppose that the buoy is maple wood (SG = 0.6), 2 in by 2 in by 12 ft, floating in seawater (SG = 1.025). How many pounds of steel (SG = 7.85) should be added to the bottom end so that $h = 18$ in?

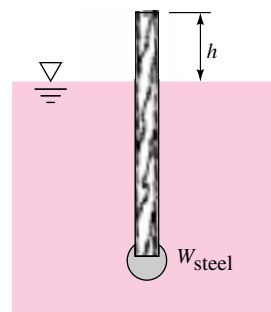

P2.113

- P2.114** The uniform rod in Fig. P2.114 is hinged at point B on the waterline and is in static equilibrium as shown when 2 kg of lead (SG = 11.4) are attached to its end. What is the specific gravity of the rod material? What is peculiar about the rest angle $\theta = 30^\circ$?

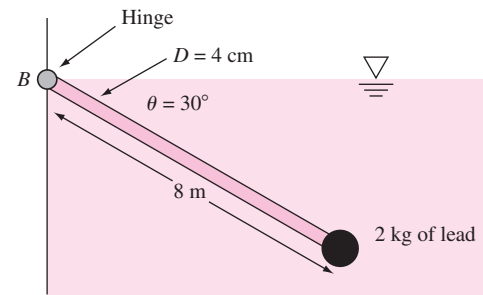

P2.114

- P2.115** The 2-in by 2-in by 12-ft spar buoy from Fig. P2.113 has 5 lbm of steel attached and has gone aground on a rock, as in Fig. P2.115. Compute the angle θ at which the buoy will lean, assuming that the rock exerts no moments on the spar.

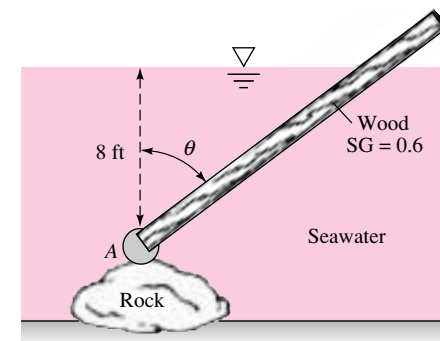

P2.115

- P2.116** The homogeneous 12-cm cube in Fig. P2.116 is balanced by a 2-kg mass on the beam scale when the cube is immersed in 20°C ethanol. What is the specific gravity of the cube?

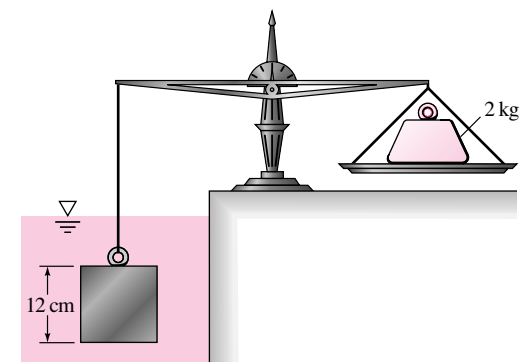

P2.116

124 Chapter 2 Pressure Distribution in a Fluid

- P2.117** The balloon in Fig. P2.117 is filled with helium and pressurized to 135 kPa and 20°C. The balloon material has a mass of 85 g/m². Estimate (a) the tension in the mooring line and (b) the height in the standard atmosphere to which the balloon will rise if the mooring line is cut.

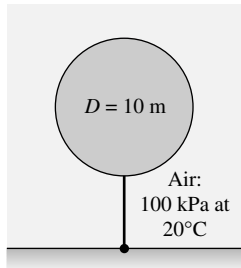

P2.117

- P2.118** A 14-in-diameter hollow sphere is made of steel ($SG = 7.85$) with 0.16-in wall thickness. How high will this sphere float in 20°C water? How much weight must be added inside to make the sphere neutrally buoyant?



- P2.119** When a 5-lbf weight is placed on the end of the uniform floating wooden beam in Fig. P2.119, the beam tilts at an angle θ with its upper right corner at the surface, as shown. Determine (a) the angle θ and (b) the specific gravity of the wood. (*Hint:* Both the vertical forces and the moments about the beam centroid must be balanced.)

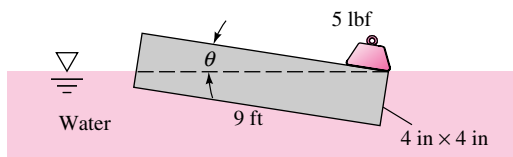

P2.119

- P2.120** A uniform wooden beam ($SG = 0.65$) is 10 cm by 10 cm by 3 m and is hinged at A, as in Fig. P2.120. At what angle θ will the beam float in the 20°C water?

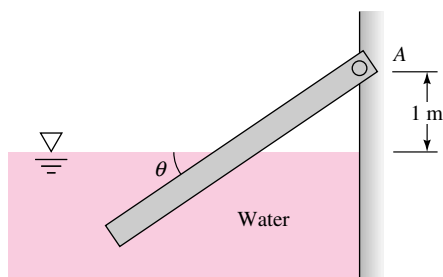

P2.120

- P2.121** The uniform beam in Fig. P2.121, of size L by h by b and with specific weight γ_b , floats exactly on its diagonal when a heavy uniform sphere is tied to the left corner, as shown. Show that this can happen only (a) when $\gamma_b = \gamma/3$ and (b) when the sphere has size

$$D = \left[\frac{Lhb}{\pi(SG - 1)} \right]^{1/3}$$

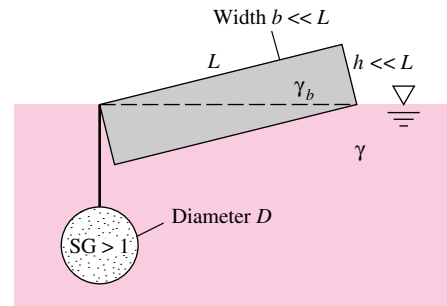

P2.121

- P2.122** A uniform block of steel ($SG = 7.85$) will “float” at a mercury–water interface as in Fig. P2.122. What is the ratio of the distances a and b for this condition?

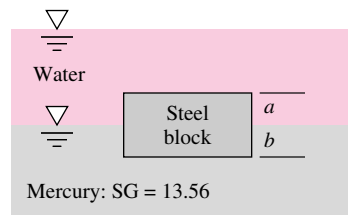

P2.122

- P2.123** A spherical balloon is filled with helium at sea level. Helium and balloon material together weigh 500 N. If the net upward lift force on the balloon is also 500 N, what is the diameter of the balloon?

- P2.124** A balloon weighing 3.5 lbf is 6 ft in diameter. It is filled with hydrogen at 18 lbf/in² absolute and 60°F and is released. At what altitude in the U.S. standard atmosphere will this balloon be neutrally buoyant?

- P2.125** Suppose that the balloon in Prob. 2.111 is constructed to have a diameter of 14 m, is filled at sea level with hot air at 70°C and 1 atm, and is released. If the air inside the balloon remains constant and the heater maintains it at 70°C, at what altitude in the U.S. standard atmosphere will this balloon be neutrally buoyant?

- P2.126** A block of wood (SG = 0.6) floats in fluid X in Fig. P2.126 such that 75 percent of its volume is submerged in fluid X. Estimate the vacuum pressure of the air in the tank.

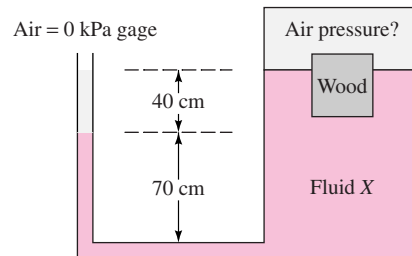

P2.126

- *P2.127** Consider a cylinder of specific gravity $S < 1$ floating vertically in water ($S = 1$), as in Fig. P2.127. Derive a formula for the stable values of D/L as a function of S and apply it to the case $D/L = 1.2$.

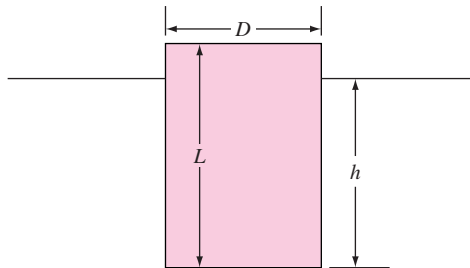

P2.127

- P2.128** An iceberg can be idealized as a cube of side length L , as in Fig. P2.128. If seawater is denoted by $S = 1.0$, then glacier ice (which forms icebergs) has $S = 0.88$. Determine if this “cubic” iceberg is stable for the position shown in Fig. P2.128.
- P2.129** The iceberg idealization in Prob. 2.128 may become unstable if its sides melt and its height exceeds its width. In Fig. P2.128 suppose that the height is L and the depth into the paper is L , but the width in the plane of the paper is $H < L$. Assuming $S = 0.88$ for the iceberg, find the ratio H/L for which it becomes neutrally stable (about to overturn).
- P2.130** Consider a wooden cylinder (SG = 0.6) 1 m in diameter and 0.8 m long. Would this cylinder be stable if placed to float with its axis vertical in oil (SG = 0.8)?
- P2.131** A barge is 15 ft wide and 40 ft long and floats with a draft of 4 ft. It is piled so high with gravel that its center of gravity is 2 ft above the waterline. Is it stable?

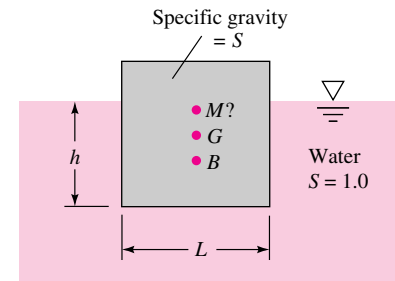

P2.128

- P2.132** A solid right circular cone has SG = 0.99 and floats vertically as in Fig. P2.132. Is this a stable position for the cone?

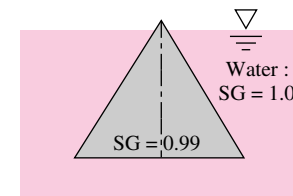

P2.132

- P2.133** Consider a uniform right circular cone of specific gravity $S < 1$, floating with its vertex down in water ($S = 1$). The base radius is R and the cone height is H . Calculate and plot the stability MG of this cone, in dimensionless form, versus H/R for a range of $S < 1$.

- P2.134** When floating in water (SG = 1.0), an equilateral triangular body (SG = 0.9) might take one of the two positions shown in Fig. P2.134. Which is the more stable position? Assume large width into the paper.

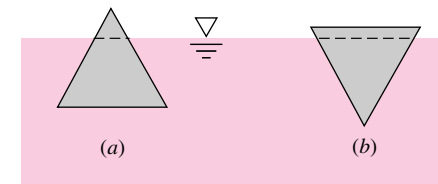

P2.134

- P2.135** Consider a homogeneous right circular cylinder of length L , radius R , and specific gravity SG, floating in water (SG = 1). Show that the body will be stable with its axis vertical if

$$\frac{R}{L} > [2SG(1 - SG)]^{1/2}$$

- P2.136** Consider a homogeneous right circular cylinder of length L , radius R , and specific gravity SG = 0.5, floating in water (SG = 1). Show that the body will be stable with its axis horizontal if $L/R > 2.0$.

126 Chapter 2 Pressure Distribution in a Fluid

P2.137 A tank of water 4 m deep receives a constant upward acceleration a_z . Determine (a) the gage pressure at the tank bottom if $a_z = 5 \text{ m}^2/\text{s}$ and (b) the value of a_z that causes the gage pressure at the tank bottom to be 1 atm.

P2.138 A 12-fl-oz glass, of 3-in diameter, partly full of water, is attached to the edge of an 8-ft-diameter merry-go-round, which is rotated at 12 r/min. How full can the glass be before water spills? (*Hint*: Assume that the glass is much smaller than the radius of the merry-go-round.)

P2.139 The tank of liquid in Fig. P2.139 accelerates to the right with the fluid in rigid-body motion. (a) Compute a_x in m/s^2 . (b) Why doesn't the solution to part (a) depend on the density of the fluid? (c) Determine the gage pressure at point A if the fluid is glycerin at 20°C .

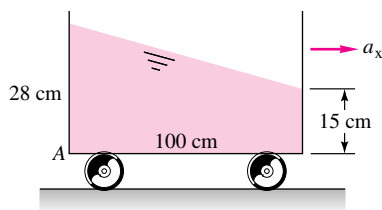

P2.139

P2.140 Suppose that the elliptical-end fuel tank in Prob. 2.101 is 10 m long and filled completely with fuel oil ($\rho = 890 \text{ kg}/\text{m}^3$). Let the tank be pulled along a horizontal road. For rigid-body motion, find the acceleration, and its direction, for which (a) a constant-pressure surface extends from the top of the front end wall to the bottom of the back end and (b) the top of the back end is at a pressure 0.5 atm lower than the top of the front end.

P2.141 The same tank from Prob. 2.139 is now moving with constant acceleration up a 30° inclined plane, as in Fig. P2.141. Assuming rigid-body motion, compute (a) the value of the acceleration a , (b) whether the acceleration is up or down, and (c) the gage pressure at point A if the fluid is mercury at 20°C .

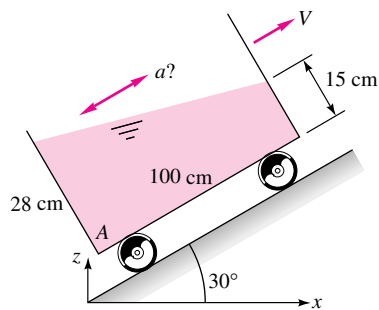

P2.141

P2.142 The tank of water in Fig. P2.142 is 12 cm wide into the paper. If the tank is accelerated to the right in rigid-body motion at $6.0 \text{ m}/\text{s}^2$, compute (a) the water depth on side AB and (b) the water-pressure force on panel AB. Assume no spilling.

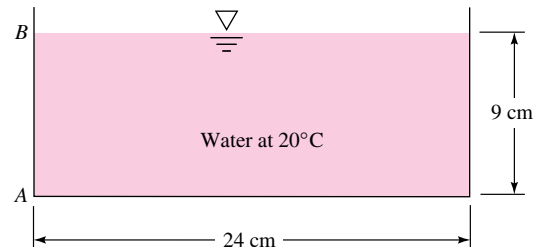

P2.142

P2.143 The tank of water in Fig. P2.143 is full and open to the atmosphere at point A. For what acceleration a_x in ft/s^2 will the pressure at point B be (a) atmospheric and (b) zero absolute?

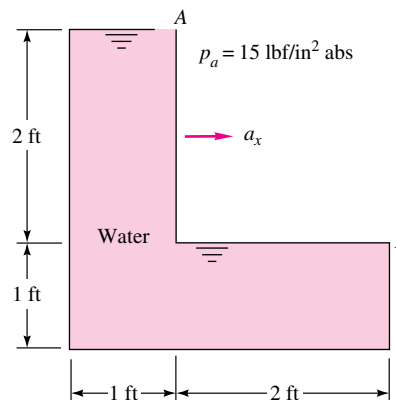

P2.143

P2.144 Consider a hollow cube of side length 22 cm, filled completely with water at 20°C . The top surface of the cube is horizontal. One top corner, point A, is open through a small hole to a pressure of 1 atm. Diagonally opposite to point A is top corner B. Determine and discuss the various rigid-body accelerations for which the water at point B begins to cavitate, for (a) horizontal motion and (b) vertical motion.

P2.145 A fish tank 14 in deep by 16 by 27 in is to be carried in a car that may experience accelerations as high as $6 \text{ m}/\text{s}^2$. What is the maximum water depth that will avoid spilling in rigid-body motion? What is the proper alignment of the tank with respect to the car motion?

- P2.146** The tank in Fig. P2.146 is filled with water and has a vent hole at point A. The tank is 1 m wide into the paper. Inside the tank, a 10-cm balloon, filled with helium at 130 kPa, is tethered centrally by a string. If the tank accelerates to the right at 5 m/s^2 in rigid-body motion, at what angle will the balloon lean? Will it lean to the right or to the left?

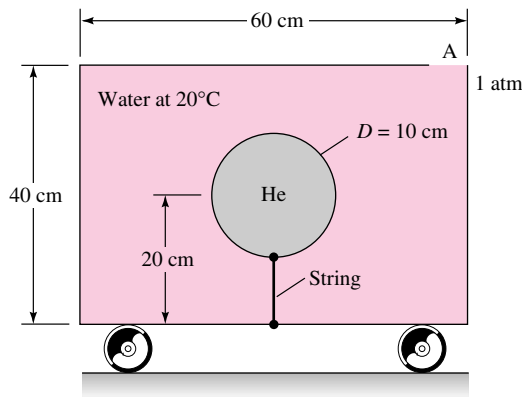

P2.146

- P2.147** The tank of water in Fig. P2.147 accelerates uniformly by freely rolling down a 30° incline. If the wheels are frictionless, what is the angle θ ? Can you explain this interesting result?

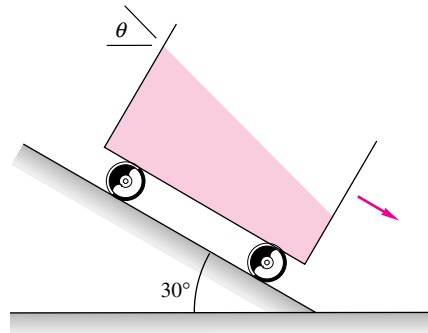

P2.147

- P2.148** A child is holding a string onto which is attached a helium-filled balloon. (a) The child is standing still and suddenly accelerates forward. In a frame of reference moving with the child, which way will the balloon tilt, forward or backward? Explain. (b) The child is now sitting in a car that is stopped at a red light. The helium-filled balloon is not in contact with any part of the car (seats, ceiling, etc.) but is held in place by the string, which is in turn held by the child. All the windows in the car are closed. When the traffic light turns

green, the car accelerates forward. In a frame of reference moving with the car and child, which way will the balloon tilt, forward or backward? Explain. (c) Purchase or borrow a helium-filled balloon. Conduct a scientific experiment to see if your predictions in parts (a) and (b) above are correct. If not, explain.

- P2.149** The 6-ft-radius waterwheel in Fig. P2.149 is being used to lift water with its 1-ft-diameter half-cylinder blades. If the wheel rotates at 10 r/min and rigid-body motion is assumed, what is the water surface angle θ at position A?

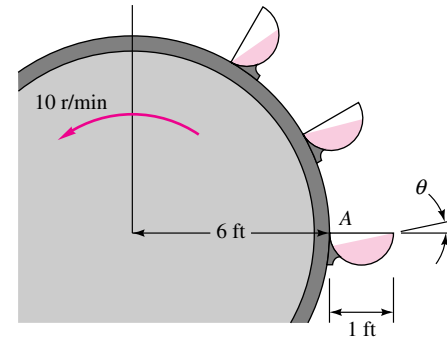

P2.149

- P2.150** A cheap accelerometer, probably worth the price, can be made from a U-tube as in Fig. P2.150. If $L = 18 \text{ cm}$ and $D = 5 \text{ mm}$, what will h be if $a_x = 6 \text{ m/s}^2$? Can the scale markings on the tube be linear multiples of a_x ?

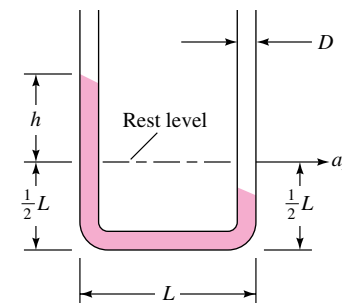

P2.150

- P2.151** The U-tube in Fig. P2.151 is open at A and closed at D. If accelerated to the right with uniform a_x , what acceleration will cause the pressure at point C to be atmospheric? The fluid is water ($\text{SG} = 1.0$).

- P2.152** A 16-cm-diameter open cylinder 27 cm high is full of water. Compute the rigid-body rotation rate about its central axis, in r/min, (a) for which one-third of the water will spill out and (b) for which the bottom will be bare exposed.

128 Chapter 2 Pressure Distribution in a Fluid

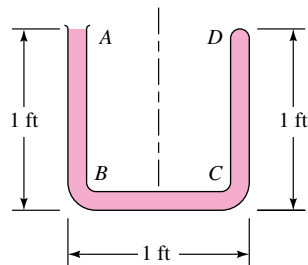

P2.151

P2.153 Suppose the U-tube in Fig. P2.150 is not translated but rather rotated about its right leg at 95 r/min. What will be the level h in the left leg if $L = 18$ cm and $D = 5$ mm?

P2.154 A very deep 18-cm-diameter can contains 12 cm of water overlaid with 10 cm of SAE 30 oil. If the can is rotated in rigid-body motion about its central axis at 150 r/min, what will be the shapes of the air–oil and oil–water interfaces? What will be the maximum fluid pressure in the can in Pa (gage)?

P2.155 For what uniform rotation rate in r/min about axis C will the U-tube in Fig. P2.155 take the configuration shown? The fluid is mercury at 20°C.

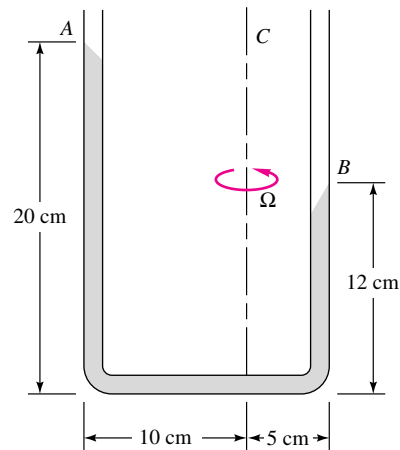

P2.155

P2.156 Suppose that the U-tube of Fig. P2.151 is rotated about axis DC . If the fluid is water at 122°F and atmospheric pressure is 2116 lbf/ft² absolute, at what rotation rate will the fluid within the tube begin to vaporize? At what point will this occur?

P2.157 The 45° V-tube in Fig. P2.157 contains water and is open at A and closed at C . What uniform rotation rate in r/min about axis AB will cause the pressure to be equal at points B and C ? For this condition, at what point in leg BC will the pressure be a minimum?

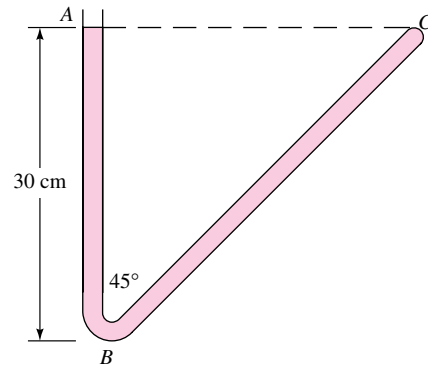

P2.157

***P2.158** It is desired to make a 3-m-diameter parabolic telescope mirror by rotating molten glass in rigid-body motion until the desired shape is achieved and then cooling the glass to a solid. The focus of the mirror is to be 4 m from the mirror, measured along the centerline. What is the proper mirror rotation rate, in r/min, for this task?



P2.159 The three-legged manometer in Fig. P2.159 is filled with water to a depth of 20 cm. All tubes are long and have equal small diameters. If the system spins at angular velocity Ω about the central tube, (a) derive a formula to find the change of height in the tubes; (b) find the height in cm in each tube if $\Omega = 120$ r/min. (Hint: The central tube must supply water to both the outer legs.)

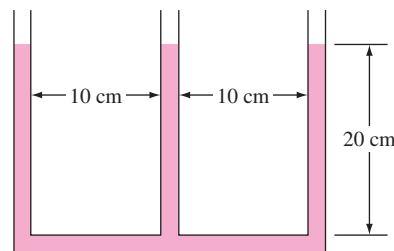

P2.159

Word Problems

W2.1 Consider a hollow cone with a vent hole in the vertex at the top, along with a hollow cylinder, open at the top, with the same base area as the cone. Fill both with water to the top. The *hydrostatic paradox* is that both containers have

the same force on the bottom due to the water pressure, although the cone contains 67 percent less water. Can you explain the paradox?

W2.2 Can the temperature ever *rise* with altitude in the real

- atmosphere? Wouldn't this cause the air pressure to increase upward? Explain the physics of this situation.
- W2.3** Consider a submerged curved surface that consists of a two-dimensional circular arc of arbitrary angle, arbitrary depth, and arbitrary orientation. Show that the resultant hydrostatic pressure force on this surface must pass through the center of curvature of the arc.
- W2.4** Fill a glass approximately 80 percent with water, and add a large ice cube. Mark the water level. The ice cube, having $SG \approx 0.9$, sticks up out of the water. Let the ice cube melt with negligible evaporation from the water surface. Will the water level be higher than, lower than, or the same as before?
- W2.5** A ship, carrying a load of steel, is trapped while floating in a small closed lock. Members of the crew want to get out, but they can't quite reach the top wall of the lock.

A crew member suggests throwing the steel overboard in the lock, claiming the ship will then rise and they can climb out. Will this plan work?

- W2.6** Consider a balloon of mass m floating neutrally in the atmosphere, carrying a person/basket of mass $M > m$. Discuss the stability of this system to disturbances.
- W2.7** Consider a helium balloon on a string tied to the seat of your stationary car. The windows are closed, so there is no air motion within the car. The car begins to accelerate forward. Which way will the balloon lean, forward or backward? (*Hint:* The acceleration sets up a horizontal pressure gradient in the air within the car.)
- W2.8** Repeat your analysis of Prob. W2.7 to let the car move at constant velocity and go around a curve. Will the balloon lean in, toward the center of curvature, or out?

Fundamentals of Engineering Exam Problems

- FE2.1** A gage attached to a pressurized nitrogen tank reads a gage pressure of 28 in of mercury. If atmospheric pressure is 14.4 psia, what is the absolute pressure in the tank?
(a) 95 kPa, (b) 99 kPa, (c) 101 kPa, (d) 194 kPa, (e) 203 kPa
- FE2.2** On a sea-level standard day, a pressure gage, moored below the surface of the ocean ($SG = 1.025$), reads an absolute pressure of 1.4 MPa. How deep is the instrument?
(a) 4 m, (b) 129 m, (c) 133 m, (d) 140 m, (e) 2080 m
- FE2.3** In Fig. FE2.3, if the oil in region B has $SG = 0.8$ and the absolute pressure at point A is 1 atm, what is the absolute pressure at point B ?
(a) 5.6 kPa, (b) 10.9 kPa, (c) 107 kPa, (d) 112 kPa, (e) 157 kPa

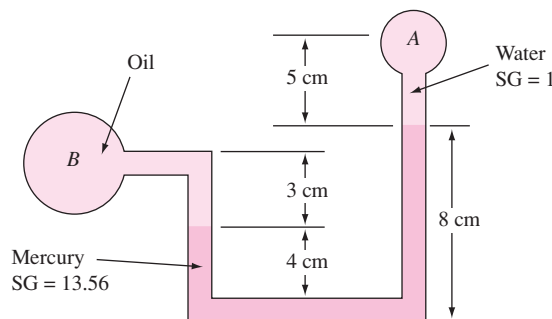

FE2.3

- FE2.4** In Fig. FE2.3, if the oil in region B has $SG = 0.8$ and the absolute pressure at point B is 14 psia, what is the absolute pressure at point A ?
(a) 11 kPa, (b) 41 kPa, (c) 86 kPa, (d) 91 kPa, (e) 101 kPa
- FE2.5** A tank of water ($SG = 1.0$) has a gate in its vertical wall 5 m high and 3 m wide. The top edge of the gate is 2 m below the surface. What is the hydrostatic force on the gate?
(a) 147 kN, (b) 367 kN, (c) 490 kN, (d) 661 kN, (e) 1028 kN
- FE2.6** In Prob. FE2.5, how far below the surface is the center of pressure of the hydrostatic force?
(a) 4.50 m, (b) 5.46 m, (c) 6.35 m, (d) 5.33 m, (e) 4.96 m
- FE2.7** A solid 1-m-diameter sphere floats at the interface between water ($SG = 1.0$) and mercury ($SG = 13.56$) such that 40 percent is in the water. What is the specific gravity of the sphere?
(a) 6.02, (b) 7.28, (c) 7.78, (d) 8.54, (e) 12.56
- FE2.8** A 5-m-diameter balloon contains helium at 125 kPa absolute and 15°C , moored in sea-level standard air. If the gas constant of helium is $2077 \text{ m}^2/(\text{s}^2 \cdot \text{K})$ and balloon material weight is neglected, what is the net lifting force of the balloon?
(a) 67 N, (b) 134 N, (c) 522 N, (d) 653 N, (e) 787 N
- FE2.9** A square wooden ($SG = 0.6$) rod, 5 cm by 5 cm by 10 m long, floats vertically in water at 20°C when 6 kg of steel ($SG = 7.84$) are attached to one end. How high above the water surface does the wooden end of the rod protrude?
(a) 0.6 m, (b) 1.6 m, (c) 1.9 m, (d) 2.4 m, (e) 4.0 m

130 Chapter 2 Pressure Distribution in a Fluid

- FE2.10** A floating body will be stable when its
 (a) center of gravity is above its center of buoyancy, (b)
 center of buoyancy is below the waterline, (c) center of

buoyancy is above its metacenter, (d) metacenter is above its center of buoyancy, (e) metacenter is above its center of gravity

Comprehensive Problems

- C2.1** Some manometers are constructed as in Fig. C2.1, where one side is a large reservoir (diameter D) and the other side is a small tube of diameter d , open to the atmosphere. In such a case, the height of manometer liquid on the reservoir side does not change appreciably. This has the advantage that only one height needs to be measured rather than two. The manometer liquid has density ρ_m while the air has density ρ_a . Ignore the effects of surface tension. When there is no pressure difference across the manometer, the elevations on both sides are the same, as indicated by the dashed line. Height h is measured from the zero pressure level as shown. (a) When a high pressure is applied to the left side, the manometer liquid in the large reservoir goes down, while that in the tube at the right goes up to conserve mass. Write an exact expression for $p_{1\text{gage}}$, taking into account the movement of the surface of the reservoir. Your equation should give $p_{1\text{gage}}$ as a function of h , ρ_m , and the physical parameters in the problem, h , d , D , and gravity constant g . (b) Write an approximate expression for $p_{1\text{gage}}$, neglecting the change in elevation of the surface of the reservoir liquid. (c) Suppose $h = 0.26$ m in a certain application. If $p_a = 101,000$ Pa and the manometer liquid has a density of 820 kg/m³, estimate the ratio D/d required to keep the error of the approximation of part (b) within 1 percent of the exact measurement of part (a). Repeat for an error within 0.1 percent.

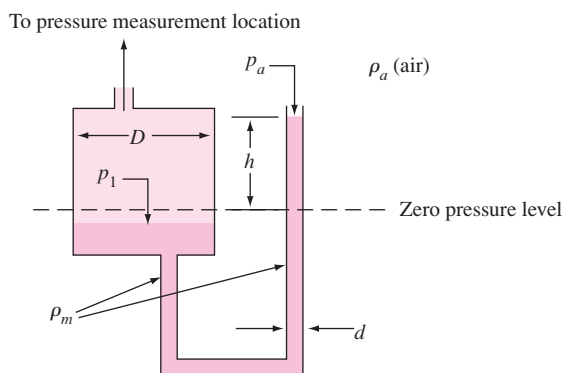

C2.1

- C2.2** A prankster has added oil, of specific gravity SG_0 , to the left leg of the manometer in Fig. C2.2. Nevertheless, the U-tube is still useful as a pressure-measuring device. It is

attached to a pressurized tank as shown in the figure. (a) Find an expression for h as a function of H and other parameters in the problem. (b) Find the special case of your result in (a) when $p_{\text{tank}} = p_a$. (c) Suppose $H = 5.0$ cm, p_a is 101.2 kPa, p_{tank} is 1.82 kPa higher than p_a , and $SG_0 = 0.85$. Calculate h in cm, ignoring surface tension effects and neglecting air density effects.

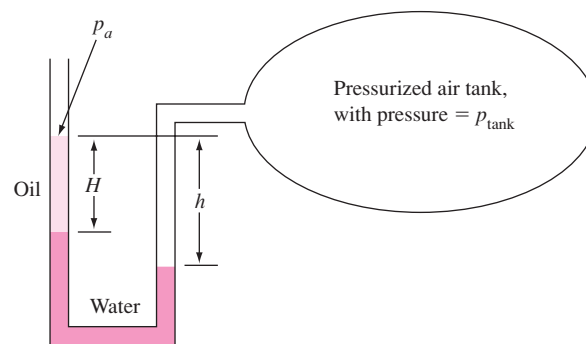

C2.2

- C2.3** Professor F. Dynamics, riding the merry-go-round with his son, has brought along his U-tube manometer. (You never know when a manometer might come in handy.) As shown in Fig. C2.3, the merry-go-round spins at constant angular velocity and the manometer legs are 7 cm apart. The manometer center is 5.8 m from the axis of rotation. Determine the height difference h in two ways: (a) approximately, by assuming rigid-body translation with \mathbf{a} equal to the average manometer acceleration; and (b) exactly, using rigid-body rotation theory. How good is the approximation?
- C2.4** A student sneaks a glass of cola onto a roller coaster ride. The glass is cylindrical, twice as tall as it is wide, and filled to the brim. He wants to know what percent of the cola he should drink before the ride begins, so that none of it spills during the big drop, in which the roller coaster achieves 0.55 -g acceleration at a 45° angle below the horizontal. Make the calculation for him, neglecting sloshing and assuming that the glass is vertical at all times.
- C2.5** *Dry adiabatic lapse rate* (DALR) is defined as the negative value of atmospheric temperature gradient, dT/dz ,

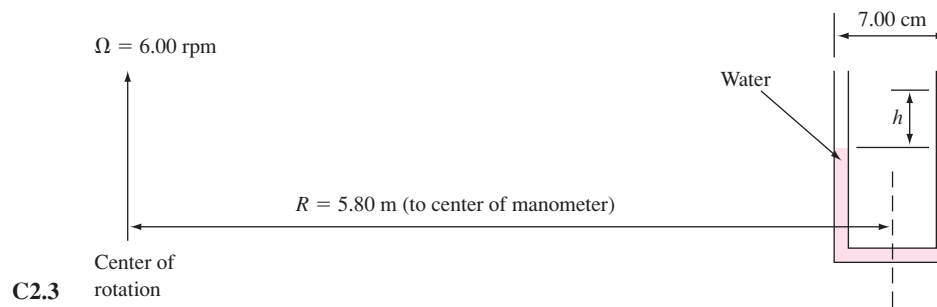

when temperature and pressure vary in an isentropic fashion. Assuming air is an ideal gas, $\text{DALR} = -dT/dz$ when $T = T_0(p/p_0)^a$, where exponent $a = (k-1)/k$, $k = c_p/c_v$ is the ratio of specific heats, and T_0 and p_0 are the temperature and pressure at sea level, respectively. (a) Assuming that hydrostatic conditions exist in the atmosphere, show that the dry adiabatic lapse rate is constant and is given by $\text{DALR} = g(k-1)/(kR)$, where R is the ideal gas constant for air. (b) Calculate the numerical value of DALR for air in units of $^\circ\text{C}/\text{km}$.

- C2.6** In “soft” liquids (low bulk modulus β), it may be necessary to account for liquid compressibility in hydrostatic calculations. An approximate density relation would be

$$dp \approx \frac{\beta}{\rho} d\rho = a^2 d\rho \quad \text{or} \quad p \approx p_0 + a^2(\rho - \rho_0)$$

where a is the speed of sound and (p_0, ρ_0) are the conditions at the liquid surface $z = 0$. Use this approximation to show that the density variation with depth in a soft liquid is $\rho = \rho_0 e^{-gz/a^2}$ where g is the acceleration of gravity and z is positive upward. Then consider a vertical wall of width b , extending from the surface ($z = 0$) down to depth $z = -h$. Find an analytic expression for the hydrostatic force F on this wall, and compare it with the incompressible result $F = \rho_0 g h^2 b / 2$. Would the center of pressure be below the incompressible position $z = -2h/3$?

Design Projects

- D2.1** It is desired to have a bottom-moored, floating system that creates a nonlinear force in the mooring line as the water level rises. The design force F need only be accurate in the range of seawater depths h between 6 and 8 m, as shown in the accompanying table. Design a buoyant system that will provide this force distribution. The system should be practical (of inexpensive materials and simple construction).

$h, \text{ m}$	$F, \text{ N}$	$h, \text{ m}$	$F, \text{ N}$
6.00	400	7.25	554
6.25	437	7.50	573
6.50	471	7.75	589
6.75	502	8.00	600
7.00	530		

- D2.2** A laboratory apparatus used in some universities is shown in Fig. D2.2. The purpose is to measure the hydrostatic force on the flat face of the circular-arc block and compare it with the theoretical value for given depth h . The counterweight is arranged so that the pivot arm is horizontal when the block is not submerged, whence the weight W can be correlated with the hydrostatic force when the submerged arm is again brought to horizontal. First show that the apparatus concept is valid in principle; then derive a formula for W as a function of h in terms of the system parameters. Finally, suggest some appropriate values of Y , L , and so on for a suitable apparatus and plot theoretical W versus h for these values.

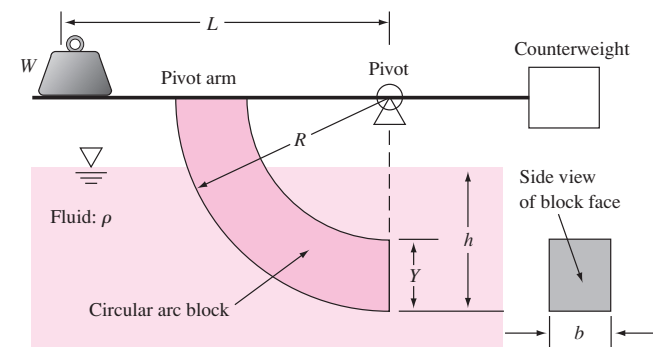

D2.2

132 Chapter 2 Pressure Distribution in a Fluid

D2.3 The Leary Engineering Company (see *Popular Science*, November 2000, p. 14) has proposed a ship hull with hinges that allow it to open into a flatter shape when entering shallow water. A simplified version is shown in Fig. D2.3. In deep water, the hull cross section would be triangular, with large draft. In shallow water, the hinges would open to an angle as high as $\theta = 45^\circ$. The dashed

line indicates that the bow and stern would be closed. Make a parametric study of this configuration for various θ , assuming a reasonable weight and center of gravity location. Show how the draft, the metacentric height, and the ship's stability vary as the hinges are opened. Comment on the effectiveness of this concept.

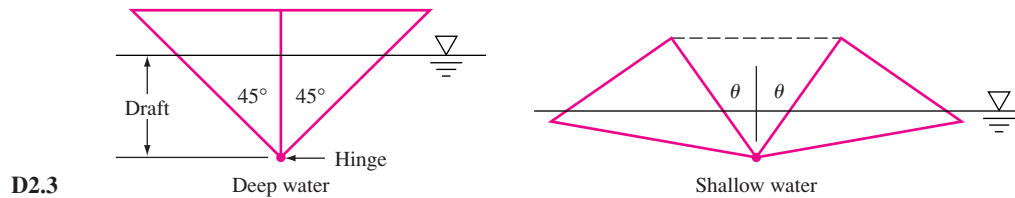

References

1. *U.S. Standard Atmosphere*, 1976, Government Printing Office, Washington, DC, 1976.
2. G. L. Pickard, *Descriptive Physical Oceanography*, Butterworth-Heinemann, Woburn, MA, 1990.
3. E. C. Tupper, *Introduction to Naval Architecture*, 3d ed., Butterworth-Heinemann, Woburn, MA, 1996.
4. D. T. Greenwood, *Principles of Dynamics*, 2d ed., Prentice-Hall, Englewood Cliffs, NJ, 1988.
5. R. I. Fletcher, "The Apparent Field of Gravity in a Rotating Fluid System," *Am. J. Phys.*, vol. 40, July 1972, pp. 959–965.
6. National Committee for Fluid Mechanics Films, *Illustrated Experiments in Fluid Mechanics*, M.I.T. Press, Cambridge, MA, 1972.
7. J. P. Holman, *Experimental Methods for Engineers*, 6th ed., McGraw-Hill, New York, 1993.
8. R. P. Benedict, *Fundamentals of Temperature, Pressure, and Flow Measurement*, 3d ed., Wiley, New York, 1984.
9. T. G. Beckwith and R. G. Marangoni, *Mechanical Measurements*, 5th ed., Addison-Wesley, Reading, MA, 1993.
10. J. W. Dally, W. F. Riley, and K. G. McConnell, *Instrumentation for Engineering Measurements*, Wiley, New York, 1984.
11. E. N. Gilbert, "How Things Float," *Am. Math. Monthly*, vol. 98, no. 3, 1991, pp. 201–216.
12. R. J. Figliola and D. E. Beasley, *Theory and Design for Mechanical Measurements*, 3d ed., Wiley, New York, 2000.
13. R. W. Miller, *Flow Measurement Engineering Handbook*, 3d ed., McGraw-Hill, New York, 1996.
14. L. D. Clayton, E. P. EerNisse, R. W. Ward, and R. B. Wiggins, "Miniature Crystalline Quartz Electromechanical Structures," *Sensors and Actuators*, vol. 20, Nov. 15, 1989, pp. 171–177.
15. J. H. Bell et al., "Surface Pressure Measurements Using Luminescent Coatings," *Annual Review of Fluid Mechanics*, vol. 33, 2001, pp. 155–206.

