

Student Solutions Manual

to accompany

Differential Equations

A Modeling Approach

Glenn Ledder

University of Nebraska - Lincoln



Higher Education

Boston Burr Ridge, IL Dubuque, IA Madison, WI New York San Francisco St. Louis
Bangkok Bogotá Caracas Kuala Lumpur Lisbon London Madrid Mexico City
Milan Montreal New Delhi Santiago Seoul Singapore Sydney Taipei Toronto

The McGraw-Hill Companies

Student Solutions Manual to accompany
LEDDER: DIFFERENTIAL EQUATIONS: A MODELING APPROACH
GLENN LEDDER

Published by McGraw-Hill Higher Education, an imprint of The McGraw-Hill Companies, Inc., 1221 Avenue of the Americas, New York, NY 10020. Copyright © 2005 by The McGraw-Hill Companies, Inc. All rights reserved.

No part of this publication may be reproduced or distributed in any form or by any means, or stored in a database or retrieval system, without the prior written consent of The McGraw-Hill Companies, Inc., including, but not limited to, network or other electronic storage or transmission, or broadcast for distance learning.

www.mhhe.com

CONTENTS

Chapter 1	INTRODUCTION	1
1.1	Natural Decay and Natural Growth	1
1.2	Differential Equations and Solutions	3
1.3	Mathematical Models and Mathematical Modeling	4
Chapter 2	BASIC CONCEPTS AND TECHNIQUES	6
2.1	A Collection of Mathematical Models	6
2.2	Separable First-Order Equations	10
2.3	Slope Fields	13
2.4	Existence of Unique Solutions	16
2.5	Euler's Method	19
2.6	Runge-Kutta Methods	22
Chapter 3	HOMOGENEOUS LINEAR EQUATIONS	25
3.1	Linear Oscillators	25
3.2	Systems of Linear Algebraic Equations	27
3.3	Theory of Homogeneous Linear Equations	29
3.4	Homogeneous Linear Equations with Constant Coefficients	30
3.5	Real Solutions from Complex Characteristic Values	31
3.6	Multiple Solutions for Repeated Characteristic Values	32
3.7	Some Other Homogeneous Linear Equations	33
Chapter 4	NONHOMOGENEOUS LINEAR EQUATIONS	35
4.1	More on Linear Oscillator Models	35
4.2	General Solutions for Nonhomogeneous Equations	36
4.3	The Method of Undetermined Coefficients	37
4.4	Forced Linear Oscillators	40
4.5	Solving First-Order Linear Equations	43
4.6	Particular Solutions for Second-Order Equations by Variation of Parameters	47
Chapter 5	AUTONOMOUS EQUATIONS AND SYSTEMS	53
5.1	Population Models	53
5.2	The Phase Line	54
5.3	The Phase Plane	56
5.4	The Direction Field and Critical Points	60
5.5	Qualitative Analysis	62
Chapter 6	ANALYTICAL METHODS FOR SYSTEMS	66
6.1	Compartment Models	66
6.2	Eigenvalues and Eigenspaces	70
6.3	Linear Trajectories	73
6.4	Homogeneous Systems with Real Eigenvalues	75

Contents

6.5	Homogeneous Systems with Complex Eigenvalues	77
6.6	Additional Solutions for Deficient Matrices	80
6.7	Qualitative Behavior of Nonlinear Systems	83
Chapter 7	THE LAPLACE TRANSFORM	88
7.1	Piecewise Continuous Functions	88
7.2	Definition and Properties of the Laplace Transform	89
7.3	Solution of Initial Value Problems with the Laplace Transform	90
7.4	Piecewise Continuous and Impulsive Forcing	91
7.5	Convolution and the Impulse Response Function	93
Chapter 8	VIBRATING STRINGS: A FOCUSED INTRODUCTION TO PARTIAL DIFFERENTIAL EQUATIONS	95
8.1	Transverse Vibration of a String	95
8.2	The General Solution of the Wave Equation	98
8.3	Vibration Modes of a Finite String	99
8.4	Fourier Series	101
8.5	Motion of a Plucked String	104
Chapter A	SOME ADDITIONAL TOPICS	109
A.1	Using Integrating Factors to Solve First-Order Linear Equations	109
A.2	Proof of the Existence and Uniqueness Theorem for First Order Equations	111
A.3	Error in Numerical Methods	113
A.4	Power Series Solutions	115
A.5	Matrix Functions	119
A.6	Nonhomogeneous Linear Systems	120
A.7	The One-Dimensional Heat Equation	125
A.8	Laplace's Equation	128

Section 1.1

1. (a) The temperature in the cup would not be uniform. It would be warmer near the center and cooler near the edges. The average temperature would decrease more slowly if the liquid were not mixed.
- (b) Styrofoam would slow the rate of heat transfer, thus decreasing the value of k .
- (c) If a metal spoon is used in place of a plastic one, more heat will be transferred to the spoon. More importantly, the metal spoon will also transfer heat to the surrounding atmosphere having the net effect of increasing the surface area in contact with the outside atmosphere. The effect is similar to that of adding a handle to the cup.

3. (a) We have

$$-\frac{dT}{dt} = k(T - 10), \quad T(0) = 68, \quad k = \frac{1}{9} \ln \left(\frac{58}{47} \right).$$

- (b) $T(18) = 58e^{18 \ln(58/47)/9} + 10 \approx 48$ degrees. This model predicts the pipes would not freeze.
 - (c) We assumed that the outside temperature is constant. It is reasonable to expect that the outside temperature would fall after sunset, which would lead the house to cool faster. It would make sense to revise the estimate downward.
5. The governing equation is $\frac{dy}{dt} = -kt$. The solution is $y(t) = Ce^{-kt}$. We are told that $y(29) = C/2$; thus, $k = \ln 2/29$. Therefore, $y(30) = 0.488C$; hence, approximately 49% is still present. Solving for $y(t) = C/100$ yields $t = 29 \ln(100)/\ln 2 \approx 192.67$ years.

7. (a) We know that $\frac{dy}{dt} = -ky$ and $Q(t) = ky(t)$. Thus, $\frac{dQ}{dt} = k\frac{dy}{dt} = -k^2y = -kQ$, which shows that Q decays exponentially.

- (b) Using the solution from Example 4, $Q = kCe^{-kt}$, where $C = 1$ gram and $k = 1.537 \times 10^{-10} \text{ yr}^{-1}$. Thus, $Q(0) = kC = 1.537 \times 10^{-10}$ and $Q(1.14 \times 10^9) = 1.2899 \times 10^{-10}$. Alternatively, if we know that $Q(t) = 1.537 \times 10^{-10} e^{-1.537 \times 10^{-10} t}$, $Q(0) = 1.537 \times 10^{-10}$, and $Q(t) = 1.2899 \times 10^{-10}$, then we can solve $Q(t) = 1.2899 \times 10^{-10}$ for t to find $t = 1.14 \times 10^9$.

9. The mathematical model is

$$\frac{dy}{dt} = -ky, \quad z = \frac{y}{y+w}, \quad w = \frac{9}{17}[y(0) - y(t)].$$

The solution of the differential equation is $y = y(0)e^{-kt}$. Thus,

$$z = \frac{17}{8 + 9e^{kt}}.$$

11. (a) The initial value problem is

$$\frac{dy}{dt} = -ky, \quad y(t_0) = Q_0 + 10, \quad k = \frac{\ln 2}{3.8}$$

for a dose at time t_0 with Q_0 the value of y just prior to the dose. We have $y = Ae^{-kt}$ from the differential equation, and then $A = (Q_0 + 10)e^{kt_0}$, so

$$y = (Q_0 + 10)e^{kt_0} e^{-kt}.$$

Chapter 1: Introduction

- (b) For the interval from time 0 to time 6, we have $Q_0 = 0$ and $t_0 = 0$. From part (a), $y = 10e^{-kt}$. For the interval from time 6 to time 12, we have $Q_0 = 10e^{-6k}$ and $t_0 = 6$. Then

$$y = 10(e^{-6k} + 1)e^{6k}e^{-kt} = 10(1 + e^{6k})e^{-kt}, \quad 6 \leq t \leq 12.$$

Similarly,

$$y = 10(1 + e^{6k} + e^{12k})e^{-kt}, \quad 12 \leq t \leq 18$$

and

$$y = 10(1 + e^{6k} + e^{12k} + e^{18k})e^{-kt}, \quad t \geq 18.$$

See Figure 1.

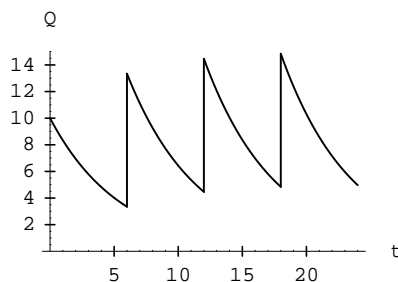

Figure 1: Exercise 1.1.11

13. (a) Let x be the amount owed and let p be the payment rate per month. Then

$$\frac{dx}{dt} = kx - p, \quad x(0) = 12000, \quad x(60) = 0.$$

Let $y = kx - p$. The problem for y is then $\frac{dy}{dt} = ky$ with $y(0) = 12000k - p$ and $y(60) = -p$. The differential equation and initial condition yield the solution $y = (12000k - p)e^{kt}$. The condition at $t = 60$ then yields $(12000k - p)e^{60k} = -p$, from which we obtain $p = 12000k/(1 - e^{-60k})$. Now, an interest rate of 5% means that the increase in amount is .05 x per year, or $\frac{.05x}{12}$ per month. Thus, $k = 1/240$ and

$$p = \frac{50}{1 - e^{-1/4}} \approx 226.04.$$

- (b) \$226.45. The error in the estimate is \$0.41, which is about 0.2% of the correct answer. The approximation is excellent.

15. The governing model is

$$\frac{dP}{dt} = kP, \quad P(0) = 203, \quad P(30) = 281,$$

with population in millions of people and $t = 0$ in 1970. Then $P(t) = Ce^{kt}$. The two additional conditions imply $C = 203$ and $k = \ln(281/203)/30 \approx 0.0108$. Thus $P(80) = 483$. The actual population will probably be less because the birthrate is much less in 2000 than in 1970 and will likely continue to decrease. This effect could be countered to some extent by a high level of immigration, but the immigration rate is far less than the overall growth rate of 1% per year.

Section 1.2

1. (a) ordinary, order 2.
 (b) partial, order 2.
 (c) ordinary, order 2.
3. $\phi = \frac{2}{5}e^{-2t} + 4e^{3t}$, $\phi' = -\frac{4}{5}e^{-2t} + 12e^{3t}$.
5. $\phi = 3 \cos t + \frac{1}{10}e^{3t}$, $\phi' = -3 \sin t + \frac{3}{10}e^{3t}$, and $\phi'' = -3 \cos t + \frac{9}{10}e^{3t}$.
7. $\phi = x^3 - 2$, $\phi' = 3x^2$, and $\phi'' = 6x$.
9. $\phi = \sqrt{1+x^2}$, $\phi' = x/\sqrt{1+x^2}$.
11. $\phi = \frac{t}{2} - \frac{1}{4} + Ce^{-2t}$, $\phi' = \frac{1}{2} - 2Ce^{-2t}$.
13. (a) Letting $y = e^{rt}$, we get $r - 3 = 0$ so $r = 3$.
 (b) Letting $y = e^{rt}$, we get $r^2 + 3r + 2 = 0$ so $r = -2, -1$.
 (c) Letting $y = e^{rt}$, we get $r^2 + 4r + 4 = 0$ so $r = -2$.
15. (a) Substituting $y = Ae^{-2t}$, we get $-2A + 3A = 1$ so $A = 1$.
 (b) Substituting $y = Ae^{-2t}$, we get $-2A - 2A = 1$ so $A = -\frac{1}{4}$.
 (c) Substituting $y = Ae^{-2t}$, we get $-2A + 2A = 1$ so there is no solution.
 (d) e^{-2t} is a solution of $y' + 2y = 0$.
17. The equilibrium solution $y = y_\infty$ satisfies $0 = 2y_\infty^2 - 2y_\infty$. Thus, $y_\infty = 0$ or $y_\infty = 1$. The solution $y_\infty = 0$ is not part of the family $1/(1 + Ce^{2t})$.
19. Rewriting this as $\frac{dt}{dy} = \frac{1}{4y}$ and integrating, $t = \frac{1}{4} \ln y + C$. Thus $y = e^{4(t-C)}$. Using the initial condition, $y = 3e^{4t}$.
21. Integrating both sides once, $\frac{dy}{dt} = -\frac{3}{2} \frac{1}{(1+2t)} + c_1$. The condition $\frac{dy}{dt}(0) = 0$ implies $c_1 = \frac{3}{2}$. Integrating again yields $y = -\frac{3}{4} \ln(1+2t) + \frac{3}{2}t + c_2$. The condition $y(0) = 1$ implies $c_2 = 1$.
23. Integrating both sides of the equation, $y = -\ln(|\cos t|) + c$. The initial condition implies $c = y_0$. Thus $y(t) = -\ln(|\cos t|) + y_0$. Since the argument of the logarithm must be positive, this solution is valid on $(-\pi/2, \pi/2)$.
25. Given that the initial condition is at $x = 3$, we write the solution as $y = \int_1^x \frac{e^{-s} ds}{s} + C$. We then have $C = 3$ and
- $$y = \int_1^x \frac{e^{-s} ds}{s} + 3.$$
27. (a) $\frac{dy}{dx} = \frac{2}{\sqrt{\pi}} e^{-x^2}$ with $y(0) = 0$.
 (b) $y = \frac{\sqrt{\pi}}{2} e^{t^2}$, $y' = \frac{\sqrt{\pi}}{2} 2te^{t^2} \operatorname{erf} t + \frac{\sqrt{\pi}}{2} e^{t^2} \frac{2}{\sqrt{\pi}} = 2ty + 1$.
29. $y = 1/(C - 2t)$, $y' = 2/(C - 2t)^2$. The initial condition implies $C = 1/2$ and $y = 2/(1 - 4t)$. The denominator of the solution must be non-zero, so the interval of existence is $(-\infty, 1/4)$.

Chapter 1: Introduction

31. $y = 1/(1 + Ce^{2t})$, $y' = -2Ce^{2t}/(1 + Ce^{2t})^2$. The initial condition implies $C = -1/2$; hence,

$$y = \frac{2}{2 - e^{2t}}.$$

The denominator of the solution must be non-zero, so the interval of existence is $(-\infty, \ln 2/2)$.

33. $y = -1/\sqrt{C - 2t}$, $y' = -1/(C - 2t)^{3/2}$. The initial condition implies $C = 1/4$; hence,

$$y = -\frac{16}{\sqrt{1 - 8t}}.$$

The argument of the square root must be non-negative, so the interval of existence is $(-\infty, 1/8)$.

Section 1.3

1. The net force is $F = -c_1y - c_2v$. Thus

$$m \frac{d^2y}{dt^2} = -c_1y - c_2 \frac{dy}{dt}.$$

The order is 2.

3. (a) We model the earth by concentrating all of the mass at the center of the earth. The distance between an object and the center of the earth is the radius of the earth, R , plus the height of the object above the center of the earth, y .

(b) We must have $F_g(0) = -mg$ and $F_g(0) = -\frac{A}{R^2}$, thus

$$A = mgR^2.$$

(c) Assuming that gravity is the only force and h is the height of the balloon above the earth's surface,

$$m \frac{d^2y}{dt^2} = -\frac{mgR^2}{(R + y)^2},$$

where $y(0) = h + R$ and $y'(0) = 0$. Yes, this can be solved by integrating both sides. Assuming that gravity and air resistance are the only forces (air resistance modeled as in Exercise 1.3.2),

$$m \frac{d^2y}{dt^2} = -\frac{mgR^2}{(R + y)^2} - k \frac{dy}{dt} \left| \frac{dy}{dt} \right|,$$

where $y(0) = h + R$ and $y'(0) = 0$. This problem cannot be solved by integrating both sides.

5. Integrating both sides of the equation, $y = \sqrt{C - 2e^t}$. Using the initial condition, we find $C = 2 + y_0^2$; thus,

$$y = \sqrt{2 + y_0^2 - 2e^t}, \quad -\infty < t < \ln \frac{1 + y_0^2}{2}.$$

7. Following the same steps as in Model Problem 1.3, we have

$$m \frac{d^2 y}{dt^2} = -mg, \quad y(0) = 0, \quad y'(0) = \frac{p}{m}.$$

The solution is $y = c_1 + c_2 t - \frac{g}{2} t^2$. The two initial conditions imply $c_1 = 0$ and $c_2 = p/m$. The velocity $y' = p/m - gt$ is zero when $t = p/(mg)$. Thus, the maximum height is

$$Y = \frac{p^2}{2gm^2}.$$

Of the three parameters, p is a property of the thrower, m is a property of the ball, and g is a constant. Thus, doubling the strength of the thrower increases the height by a factor of 4; similarly, doubling the mass of the ball decreases the height by a factor of 4.

Section 2.1

1. (a) The first assumption makes the population constant rather than variable. The second assumption means that contact between any two individuals is treated in the same way, rather than having to keep track of the contact between different types of individuals. The third assumption means that all contacts are treated equally. The fourth assumption means that the recovery process is independent of history, that is, the probability of recovery in any particular time interval does not depend on the amount of time the individual has had the disease..
 - (b) Over a small period of time (say a summer), it is reasonable to model the population as constant. It might be inappropriate over a longer time scale (for example a decade). For the second assumption, the contact between people on a crowded city street is likely to be fairly random and each person will have a similar number of contacts. If all of the contact between people comes from shaking hands, then it reasonable to expect that a predictable number of contacts between infected and healthy will result in new infections, thus making assumption three hold. The last assumption will hold for a disease that can be cured by the body at any time (possibly warts which may disappear of their own accord at any time). It will not be true for diseases that have a natural progression, e.g. flu or common cold. Nevertheless, this assumption is common in epidemiology models and usually does not introduce significant error.
 - (c) Many (most) people are neither susceptible or infective, and this category is not present in this model.
 - (d) The first two assumptions probably apply well to the common cold. The last two assumptions are more questionable. There are certainly kinds of contact that promote the spread of the common cold (e.g. kissing) and things individuals can do to reduce their own infection rate (e.g. washing hands). This brings assumption three into question. The common cold also has a natural progression (one recovers in 3-5 days). Depending on the time scale of the problem, this may be a serious issue. An alternative modeling option is to leave people in the population immediately after they are infected, but before symptoms appear, for a few days and then remove them from contact with others (while they are at home recovering). This is very different from assumption 4.
3. (a) From $dh/dt = -k\sqrt{h}$, we have the approximation

$$\Delta t \approx -\frac{\Delta h}{k\sqrt{h}} = -\frac{\sqrt{h}}{k} \frac{\Delta h}{h}.$$

Thus, measurable changes in h occur in a time of roughly $t_r = \sqrt{h_0}/k$.

(b) $\frac{dt}{dh} = -\frac{1}{k\sqrt{h}}$

(c) We have

$$\int_{h_0}^0 -\frac{1}{k\sqrt{h}} dh = \int_{h_0}^0 \frac{dt}{dh} dh = \int_0^{t_e} dt.$$

Integrating both sides yields $t_e = 2\sqrt{h_0}/k$.

- (d) The reference time is one-half of the amount of time for a bucket of depth h_0 to empty.
- (e) The substitution $h = h_0H$ yields the equation $\sqrt{h_0} \frac{dH}{dt} = -k\sqrt{H}$. From the formula $\tau = t/t_r$, we obtain

$$\frac{d}{dt} = \frac{1}{t_r} \frac{d}{d\tau};$$

hence, the dimensionless differential equation is $\frac{dH}{d\tau} = -\sqrt{H}$.

5. (a) The component of $\frac{d^2\mathbf{r}}{dt^2}$ in the direction of \mathbf{T} is s'' . The component of $\frac{d\mathbf{r}}{dt}$ in the direction of \mathbf{T} is s' . The component of $g\mathbf{k}$ in the direction of \mathbf{T} is $-g\sin\theta$. Thus we get $s'' = -bs' - g\sin\theta$, or

$$s'' + bs' + g\sin\theta = 0.$$

- (b) We have that $s = \theta L$. Thus $s' = L\theta'$ and $s'' = L\theta''$. Hence

$$\theta'' + b\theta' + (g/L)\sin\theta = 0.$$

- (c) Let $\tau = \sqrt{g/L}t$. Then the equation becomes

$$\theta'' + a\theta' + \sin\theta = 0,$$

where $a = b\sqrt{L/g}$.

7. (a) The height of a satellite is on the order of the radius of the earth. With $z_r = R$ for the length scale, we have $t_r = R/V$ for the time scale. Using $z = RZ$, we have

$$R\frac{d^2Z}{dt^2} = -\frac{g}{(1+Z)^2}, \quad Z(0) = 0, \quad R\frac{dZ}{dt}(0) = V.$$

Then, from $t = t_r\tau$, we have $\frac{d}{dt} = \frac{V}{R}\frac{d}{d\tau}$, and the problem becomes

$$\frac{d^2Z}{d\tau^2} = -\frac{gR}{V^2}\frac{1}{(1+Z)^2}, \quad Z(0) = 0, \quad \frac{dZ}{d\tau}(0) = 1.$$

The quantity $\alpha = gR/V^2$ is dimensionless.

- (b) Writing α as $R/(V^2/g)$, we see that V^2/g is a possible reference length.
 (c) Let $z = V^2Z/g$ and $t = V\tau/g$. Substitution of the Z for z changes the differential equation to

$$\frac{V^2}{g}\frac{d^2Z}{dt^2} = -\frac{g}{(1+\alpha^{-1}Z)^2}.$$

Then $\frac{d}{dt} = \frac{g}{V}\frac{d}{d\tau}$ yields

$$\frac{d^2Z}{d\tau^2} = -\frac{1}{(1+\alpha^{-1}Z)^2}.$$

Similarly, the initial conditions become $Z(0) = 0$ and $\frac{dZ}{d\tau}(0) = 1$.

- (d) α must be large.
 (e) V must be considerably larger than \sqrt{gR} .

9. Rewriting gives $\frac{d\tau}{dz} = (1-z)^{-1}e^{-pz/(1+\beta z)}$. Integrating both sides yields

$$\tau_Z = \int_0^{\tau_Z} d\tau = \int_0^Z \frac{1}{1-z} e^{-pz/(1+\beta z)} dz.$$

Chapter 2: Basic Concepts and Techniques

11. Since $e^{-pz/(1+z)} \geq e^{-p}$ we have

$$\int_0^1 \frac{e^{-pz/(1+z)}}{1-z} dz \geq e^{-p} \int_0^1 \frac{dz}{1-z}.$$

Due to the singularity in the integrand at $z = 1$,

$$\int_0^1 \frac{dz}{1-z} = \lim_{r \rightarrow 1^-} \int_0^r \frac{dz}{1-z} = \lim_{r \rightarrow 1^-} \ln|1-r| = \infty.$$

13. (a) $\frac{dQ}{dt} = \text{rate in} - \text{rate out}$; hence,

$$\frac{dQ}{dt} = 0r - \frac{Q}{V}r = -\frac{Q}{V}r.$$

(b) The solution is $Q(t) = Q_0 e^{-rt/V}$.

(c) Solve $Q(t) = 0.1Q_0$, to find $rt = V \ln 10$. For Lake Erie, $t \approx 5.88$ years, and for Lake Superior, $t \approx 425$ years.

(d) Lake Erie can be cleaned up much more quickly than Lake Superior, given equal starting levels.

15. (a) $\frac{dQ}{dt} = \text{rate in} - \text{rate out}$; hence,

$$\frac{dQ}{dt} = C_0 r - \frac{Q}{V}r, \quad Q(0) = 0.$$

(b) Let $u = Q - C_0 V$. The problem of part (a) becomes

$$\frac{du}{dt} = -\frac{ru}{V}, \quad u(0) = -C_0 V.$$

Hence, $u = -C_0 V e^{-rt/V}$ and then $Q = C_0 V (1 - e^{-rt/V})$.

(c) For $0 \leq t \leq 20$, we use the solution in part (b) to get $C/C_0 = 1 - e^{-rt/V}$ (note that the ratio of C to C_0 approaches 1 if t is allowed to approach ∞). At $t = 20$ we have $Q(20) = -C_0 V e^{-20r/V} + C_0 V$. Using as an initial condition and the solution from Exercise 13, $Q = C_0 V e^{-rt/V} (1 + e^{20r/V})$. Therefore

$$C/C_0 = e^{-rt/V} (1 + e^{20r/V}) \quad \text{for } 20 \leq t \leq 40.$$

(Note that the ratio of C to C_0 approaches 0 as t approaches ∞ .)

(d) In the course of the first 20 years, Lake Erie becomes ten times more polluted than Lake Superior. After the cleanup begins, it takes about 6 years before the pollutant level in Lake Erie is reduced to that of Lake Superior. By the 10-year mark after pollution stops, Lake Erie is very clean, while Lake Superior has changed little from its (relatively low) maximum. See Figure 2.

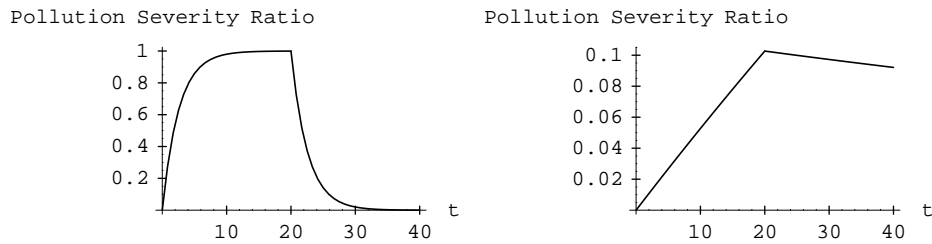

Figure 2: Exercise 2.1.15

17. (a)

$$\frac{dQ}{dt} = -kQ + \frac{Q_0}{T}, \quad Q(0) = 0$$

(b) Let $y = kQ - Q_0/T$. The problem becomes $\frac{dy}{dt} = -ky$ with $y(0) = -Q_0/T$. Thus, $y = -Q_0T^{-1}e^{-kt}$ and

$$Q = \frac{Q_0}{kT}(1 - e^{-kt}).$$

If this solution were correct for all time, Q would approach the equilibrium solution Q_0/kT .

(c) We have $Q < Q_0/kT$ for all time, and we want $Q < Q_T$. This is guaranteed to happen if we choose T so that $Q_0/kT \leq Q_T$. Thus, we choose

$$T = \frac{Q_0}{kQ_T}.$$

(d) The problem is

$$\frac{dQ}{dt} = -kQ, \quad Q(T) = \frac{Q_0}{kT}(1 - e^{-kT}).$$

The differential equation yields $Q = Ae^{-kt}$; then,

$$Ae^{-kT} = \frac{Q_0}{kT}(1 - e^{-kT}).$$

Solving for A and substituting into the formula for Q yields the result

$$Q = \frac{Q_0}{kT}(e^{kT} - 1)e^{-kt}, \quad t > T.$$

(e) The indicated substitutions yield the results

$$y = \frac{1}{S} \begin{cases} 1 - e^{-\tau} & \tau \leq S \\ (e^S - 1)e^{-\tau} & \tau \geq S. \end{cases}$$

(f) Larger S means a greater total dose relative to the maximum safe amount. This means that the graph has a later and lower peak, owing to the requirement that the drug be administered over a longer time interval. See Figure 3.

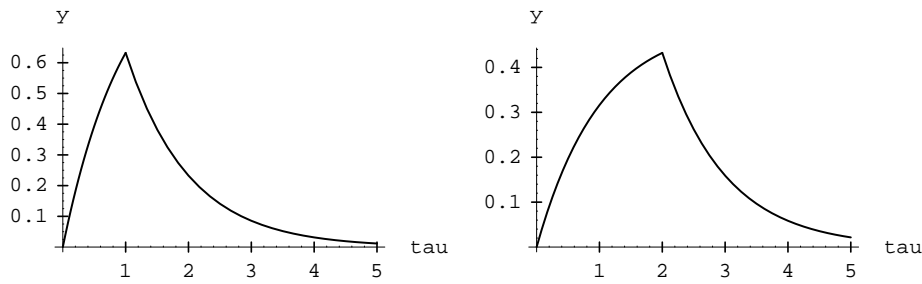

Figure 3: Exercise 2.1.17

Section 2.2

1. Separable. Evaluating $\int dy = \int (t - 1) dt$ and using the initial condition yields

$$y = \frac{1}{2}t^2 - t + 3.$$

3. Separable. Evaluating $\int y^{-3} dy = \int dt$ and using the initial condition yields

$$y = \sqrt{\frac{1}{1 - 2t}}.$$

Note that the negative root does not satisfy the initial condition.

5. Separable. Evaluating $\int y^{-2} dy = \int te^t dt$ yields

$$y = -\frac{1}{(t - 1)e^t + C}.$$

7. Separable. Evaluating $\int e^y dy = \int (\ln x/x) dx$ yields

$$y = \ln \left[\frac{1}{2}(\ln x)^2 + C \right].$$

9. Separable. Evaluating $\int y dy = -\int 2x dx$ yields

$$y = \pm\sqrt{C - 2x^2}.$$

Both square roots are included because no initial condition is specified.

11. Separable. Evaluating $\int y^2/(1 + y^3) dy = \int xe^{x^2} dx$ yields

$$y = \left(Ae^{3e^{x^2}/2} - 1 \right)^{1/3}.$$

13. Evaluating $\int y^{-2} dy = \int 2t dt$ and using the initial conditions yields

$$y = \frac{5}{1 - 5t^2}.$$

The denominator of the solution can never be zero, so the interval of existence is $(-1/\sqrt{5}, 1/\sqrt{5})$. See Figure 4.

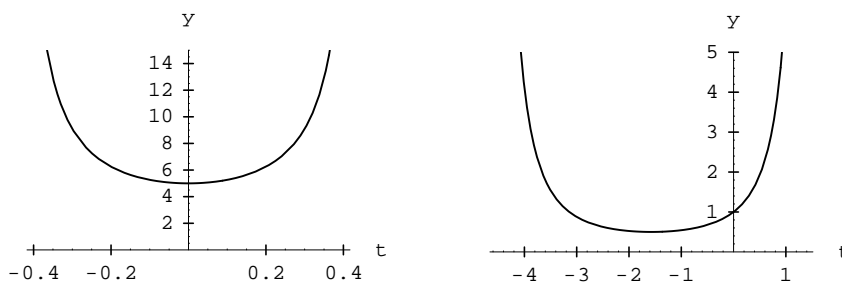

Figure 4: Exercises 2.2.13 and 2.2.15

15. Evaluating $\int y^{-2} dy = \int \cos t dt$ and using the initial conditions yields

$$y = \frac{1}{1 - \sin t}.$$

The denominator of the solution can never be zero, so the interval of existence is $(-3\pi/2, \pi/2)$. See Figure 4.

17. Evaluating $\int y/(1 + y^2) dy = \int 1/x dx$ and using the initial conditions yields

$$y = -\sqrt{5x^2 - 1}.$$

The positive root does not satisfy the initial condition. The argument of the square root must be non-negative, so the interval of existence is $[1/\sqrt{5}, \infty)$. See Figure 5.

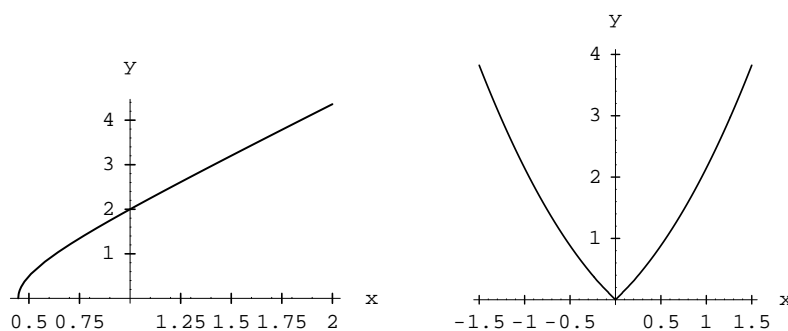

Figure 5: Exercises 2.2.17 and 2.2.19

19. Differentiating gives $\frac{dy}{dx} = 2x + \frac{1}{1+y} \frac{dy}{dx}$. See Figure 5.

21. Differentiating gives $e^y \frac{dy}{dx} + y + x \frac{dy}{dx} = 2x$. See Figure 6.

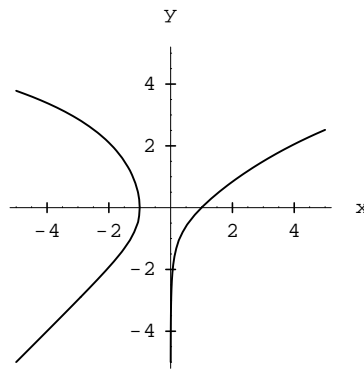

Figure 6: Exercise 2.2.21

23. (a) Evaluating $\int (y - 2) dy = \int dt$ yields $\frac{1}{2}y^2 - 2y = t + C$. Completing the square then yields $(y - 2)^2 = 2t + 2C + 4$, or

$$y = 2 \pm \sqrt{2t + c},$$

where $c = 2C + 4$.

- (b) Setting $y(0) = a$ determines $c = (a - 2)^2$. Thus

$$y = 2 \pm \sqrt{2t + (a - 2)^2}.$$

The argument of the square root must be non-negative, so the interval of existence is $[-\frac{(a-2)^2}{2}, \infty)$.

25. Differentiating, we find $dy/dx = Ae^x = y$; thus, the orthogonal family must satisfy $\frac{dy}{dx} = -1/y$. Evaluating, $\int y dy = -\int dx$ or

$$y = \pm\sqrt{c - 2x}.$$

See Figure 7.

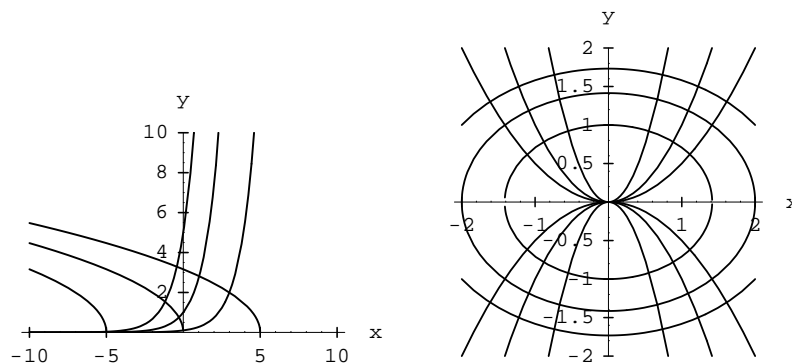

Figure 7: Exercises 2.2.25 and 2.2.27

27. Differentiating, we find $dy/dx = 2y/x$; thus, the orthogonal family must satisfy $dy/dx = -x/(2y)$. Evaluating, $\int 2y dy = \int -x dx$ or $y^2 = c - x^2/2$. This is more conveniently written as

$$2y^2 + x^2 = C^2,$$

where we have used C^2 rather than $2c$ because the constant must be nonnegative. See Figure 7.

29. Substituting $v = e^t y$, we find $\frac{dv}{dt} = e^t(2t + 2)$. Thus, $v = 2te^t + C$ and $y = 2t + Ce^{-t}$.

31. Substituting $v = e^t y$, we find $\frac{dv}{dt} = (t^2 + 2t)e^t$. Thus, $v = t^2 e^t + C$ and $y = t^2 + Ce^{-t}$.

33. Substituting $y = xv$, we find $x\frac{dv}{dx} = 1$. Thus, $v = \ln|x| + C$ and $y = x \ln|x| + Cx$.

35. Substituting $y = xv$, we find $x\frac{dv}{dx} = -v^{-1}$. Thus, $v = \pm\sqrt{C - 2\ln|x|}$ and $y = \pm x\sqrt{C - \ln x^2}$.

37. Substituting $v = (x - y)/2$, we find $\frac{dv}{dx} = (1 - v)/2$. Thus, $v = 1 - Ce^{-x/2}$ and $y = x - 2 - Ce^{-x/2}$.

39. With $v = y^2 - x^2$, we have $\frac{dv}{dx} = 2y\frac{dy}{dx} - 2x$; combining this with the differential equation yields $\frac{dv}{dx} = -2x(v + 1)$. Thus, $v = -1 + Ce^{-x^2} - 1$ and $y^2 = x^2 - 1 + Ce^{-x^2}$.

41. Differentiating $v(x) = y^2(x) - x^2$ yields

$$\frac{dv}{dx} = 2\left(y\frac{dy}{dx} - x\right).$$

This equation is separable if and only if $y\frac{dy}{dx} - x$ is separable; setting $y\frac{dy}{dx} - x = f(x)g(v)$, we obtain the requirement

$$y\frac{dy}{dx} = x + f(x)g(y^2 - x^2)$$

for some functions f and g . Note that both Exercises 39 and 40 are of the form

$$y\frac{dy}{dx} = xF(y^2 - x^2),$$

which appears to be quite different. However, setting $f(x) = x$ and $F(v) = 1 + g(v)$ in the more general form recovers this special case.

Section 2.3

1. The differential equation is $\frac{dy}{dt} = \frac{2y - 5t + 3}{t + 1}$. See Figure 8.

3. From the solution $y = 2t + Ce^{-t}$, we see that solutions approach $y = 2t$ as $t \rightarrow \infty$. The plot of the slope field, solutions curves, and isoclines are as shown. The isocline is the dashed curve. See Figure 8.

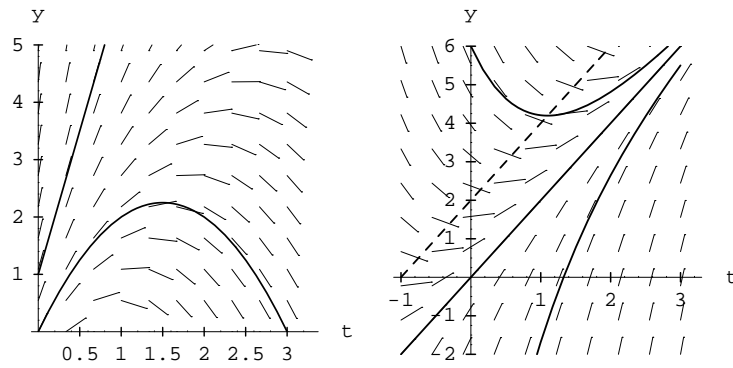

Figure 8: Exercises 2.3.1 and 2.3.3

5. From the solution $y = t^2 + Ce^{-t}$, we see that solutions approach $y = t^2$ as $t \rightarrow \infty$. The plot of the slope field, solutions curves, and isoclines are as shown. The isocline is the dashed curve. See Figure 9.

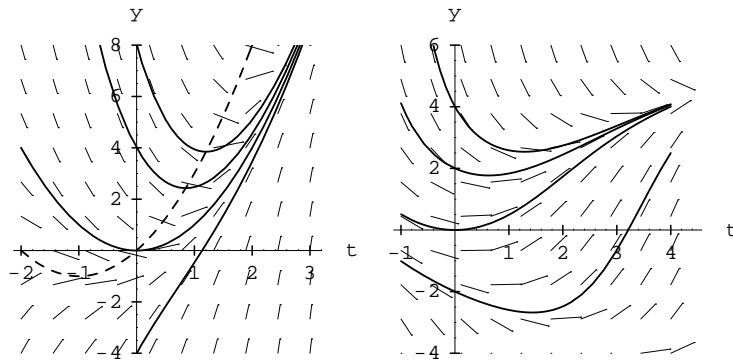

Figure 9: Exercises 2.3.5 and 2.3.7

7. This problem cannot be solved by any of the methods in a differential equations course. Mathematica gives a solution in terms of Bessel functions with imaginary arguments, while Maple gives a solution in terms of Airy functions. The slope field and solution curves can still be generated numerically. Note from the plot that the solutions seem to be approaching the $y = \sqrt{5t}$ nullcline as $t \rightarrow \infty$. This behavior can be confirmed by the method at the bottom of page 82 of the text. The guess $t \approx 0.2y^2$ yields the approximate behaviors $y = \pm\sqrt{5t}$, for which $\frac{dy}{dt} = \pm\sqrt{5/4t}$. Since the omitted term vanishes as $t \rightarrow \infty$, the formulas $y = \pm\sqrt{5t}$ capture the possible long-term behaviors. Neither of the guesses $\frac{dy}{dt} \approx t$ nor $\frac{dy}{dt} \approx -0.2y^2$ yield a consistent approximation. Note that there do not appear to be solutions that approach $y = -\sqrt{5t}$. Both the graph and the analysis are needed to obtain the correct long-term behavior result. See Figure 9.

9. The solution of the initial value problem is $y = 5/(1 - 5t^2)$ on the interval $(-\sqrt{0.2}, \sqrt{0.2})$, and the solution approaches infinity at the endpoints of the interval. See Figure 10.

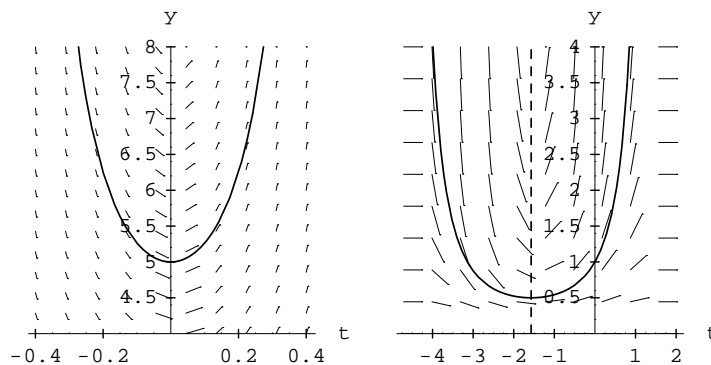

Figure 10: Exercises 2.3.9 and 2.3.11

11. The solution of the initial value problem is $y = 1/(1 - \sin t)$ on the interval $[-3\pi/2, \pi/2]$, and the solution approaches infinity at the endpoints of the interval. The isoclines are $y = 0$ and $t = -\pi/2$. See Figure 10.
13. The solution of the initial value problem is $y = -\sqrt{5x^2 - 1}$; thus, y approaches $-\sqrt{5}x$ as $x \rightarrow \infty$. There are no isoclines. See Figure 11.

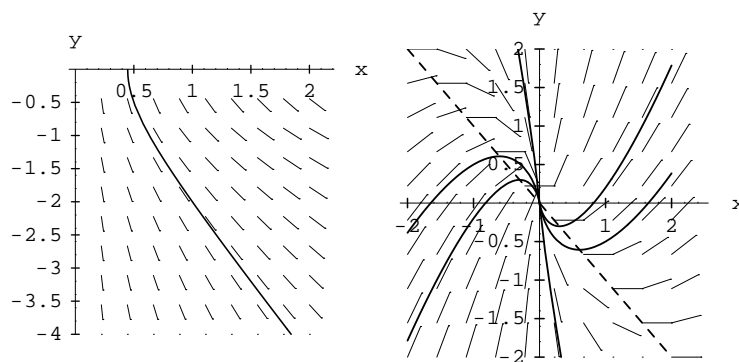

Figure 11: Exercises 2.3.13 and 2.3.15

15. The solution of the differential equation is $y = x \ln|x| + Cx$. The long-term behavior as $x \rightarrow \infty$ is $y \approx Cx$. The isocline is the dashed curve in the plot. See Figure 11.
17. The solution of the differential equation is $y = \pm x\sqrt{C - \ln x^2}$. Individual solution curves are bounded in x . The isoclines are the dashed lines in the plot. See Figure 12.

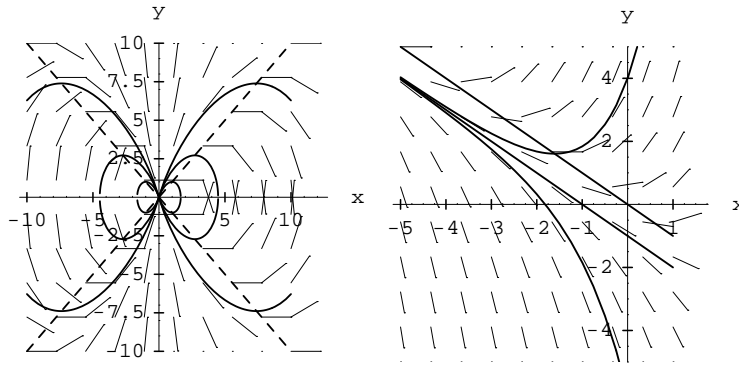

Figure 12: Exercises 2.3.17 and 2.3.19

19. Let $v(x) = x + y(x)$. Then

$$\frac{dv}{dx} = 1 + \frac{dy}{dx} = 1 + x + y = 1 + v.$$

This equation is separable, but it is also linear with constant forcing, and it is easy to solve with the substitution $v = u - 1$, after which we obtain the solution

$$y = Ae^x - 1 - x$$

with the long-term behavior $y \approx Ae^x$. The isocline is the dashed curve in the plot. See Figure 12.

21. The zero isoclines are $i = 0$ and $i = 1 - 1/R_0$. If the initial condition is $I(0) > 0$, then all solutions converge toward the value $i = 1 - 1/R_0$. See Figure 13.

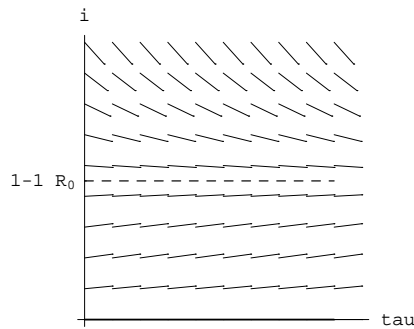

Figure 13: Exercise 2.3.21

Section 2.4

1. $f = y^{1/3}(x + 1)^{-1}$ and $\frac{\partial f}{\partial y} = \frac{1}{3}y^{-2/3}(x + 1)^{-1}$. f is not continuous at $x = -1$ and $\frac{\partial f}{\partial y}$ is not continuous at $x = -1$ and $y = 0$. Theorem 2.4.1 guarantees a unique solution if (x_0, y_0) is chosen so that $x_0 \neq -1$ and $y_0 \neq 0$.

3. $f = \sqrt{25 - t^2 - y^2}(t + y + 1)^{-1}$ and $\frac{\partial f}{\partial y} = (t^2 - 25 + ty - y)(25 - t^2 - y^2)^{-1/2}(t + y + 1)^{-2}$. f is not continuous at $y = -t - 1$ and $25 - t^2 - y^2 < 0$ and $\frac{\partial f}{\partial y}$ is not continuous at $y = -t - 1$ and $25 - t^2 - y^2 \leq 0$. Theorem 2.4.1 guarantees a unique solution if (t_0, y_0) is chosen so that $y_0 \neq -t_0 - 1$ and $y_0^2 + t_0^2 \leq 25$.

5. We have

$$p_1 = \frac{x}{(x-2)(x+1)}, \quad p_2 = \frac{1}{(x-2)(x+1)}.$$

These functions are not continuous at $x = 2$ and $x = -1$, so the guaranteed interval of existence from Theorem 2.4.2 is $(-1, 2)$.

7. We have

$$p_1 = \frac{e^x}{\cos x}, \quad g = \frac{x}{\cos x}.$$

These functions are not continuous at $x = \pi/2 + n\pi$ for $n \in \mathbb{Z}$, so the guaranteed interval of existence from Theorem 2.4.2 is $(-\pi/2, \pi/2)$.

9. This is a linear equation, so Theorem 2.4.2 applies. We have

$$p_1 = 2x \frac{dy}{dx}, \quad g = -\ln(1-x).$$

Then g is not continuous for $x < 1$, so the guaranteed interval of existence from Theorem 2.4.2 is $(-\infty, 1)$.

11. (a) This is a linear equation, so Theorem 2.4.2 applies. We have

$$p_1 = -\frac{2x}{1-x^2}, \quad p_2 = \frac{n(n+1)}{1-x^2}.$$

These functions are not continuous at $x = \pm 1$, so the guaranteed interval of existence from Theorem 2.4.2 is $(-1, 1)$.

- (b) Yes, any initial condition where $x_0 = \pm 1$.

- (c) If $n = 0$ then the equation is

$$(1-x^2) \frac{d^2y}{dx^2} - 2x \frac{dy}{dx} = 0.$$

The zeroth degree solution of this that satisfies $y(1) = 1$ is $y = 1$. If $n = 1$, then the equation is

$$(1-x^2) \frac{d^2y}{dx^2} - 2x \frac{dy}{dx} + 2y = 0.$$

To find the first degree solution of this problem, let $y = ax + b$. Substituting into the equation and using the initial condition shows $a = 1$ and $b = 0$. Thus, $y = x$. If $n = 2$, then the equation is

$$(1-x^2) \frac{d^2y}{dx^2} - 2x \frac{dy}{dx} + 6y = 0.$$

To find the second degree solution of this problem, let $y = ax^2 + bx + c$. Substituting into the equation and using the initial condition shows $a = 3/2$, $b = 0$ and $c = -1/2$. Thus, $y = \frac{3}{2}x^2 - \frac{1}{2}$. If $n = 3$, then the equation is

$$(1-x^2) \frac{d^2y}{dx^2} - 2x \frac{dy}{dx} + 12y = 0.$$

Chapter 2: Basic Concepts and Techniques

To find the third degree solution of this problem, let $y = ax^3 + bx^2 + cx + d$. Substituting into the equation and using the initial condition shows $a = 5/2$, $b = 0$, $c = -3/2$ and $d = 0$. Thus, $y = \frac{5}{2}x^3 - \frac{3}{2}x$.

(d) No, The initial condition does not satisfy the hypotheses of Theorem 2.4.1 or Theorem 2.4.2, so those theorems do not apply.

13. (a) Evaluating $\int h^{-1/2} dh = \int -2 dt$, we find $\sqrt{h} = -t + c$. The initial condition shows $c = 2$. Thus $h = (2 - t)^2$.

(b) At $t = 2$, the height of the water is zero; thus, the bucket is empty.

(c)

$$h = \begin{cases} (2 - t)^2, & t \leq 2 \\ 0, & 2 < t \end{cases}$$

(d) The function $(2 - t)^2$ satisfies the differential equation for $-\infty < t < 2$ and the zero function satisfies the differential equation for $t > 2$. It remains to check the differential equation at $t = 2$. Note

$$\lim_{t \rightarrow 2^-} \frac{dh}{dt} = 0, \quad \lim_{t \rightarrow 2^+} \frac{dh}{dt} = \lim_{t \rightarrow 2^+} (2t - 4) = 0.$$

These limits agree, and therefore $\frac{dh}{dt}(2) = 0 = \sqrt{h(2)}$. The piecewise-defined function of part (c) satisfies the differential equation for all t .

(e) No, Theorem 2.4.1 says nothing about this initial value problem since the initial condition occurs when $t_0 = 0$.

(f) See Figure 14.

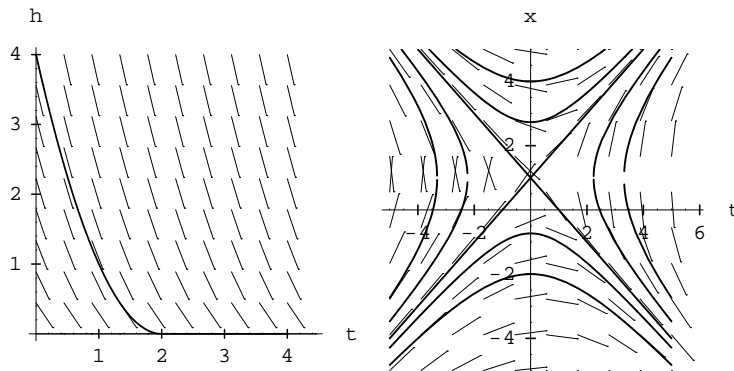

Figure 14: Exercises 2.4.13 and 2.4.15

15. (a) We have

$$f = \frac{t}{x-1}, \quad \frac{df}{dx} = -\frac{t}{(x-1)^2}.$$

Thus f and $\frac{df}{dx}$ are not continuous at $x = 1$. The hypotheses of Theorem 2.4.1 are not satisfied, so the theorem says nothing.

(b) Evaluating $\int (x-1) dx = \int t dt$ yields

$$\frac{x^2}{2} - x + \frac{t^2}{2} + C,$$

and the initial condition yields $C = -1/2$. From the quadratic formula, we obtain the solutions $x = 1 \pm t$. Both of these functions solve the initial value problem.

(c) See Figure 14.

(d) No, Theorem 2.4.1 does not apply.

19. Let $z(x, t) = x/(2\sqrt{kt})$. Note that $\partial z/\partial t = -x/(4\sqrt{kt^3}) = -z/(2t)$ and $\partial z/\partial x = 1/(2\sqrt{kt})$. From $y(x, t) = \operatorname{erf}(z(x, t))$, we have

$$\frac{\partial y}{\partial t} = \left(-\frac{z}{2t}\right) \left(\frac{2}{\sqrt{\pi}} e^{-z^2}\right) = -\frac{z}{\sqrt{\pi}t} e^{-z^2}, \quad \frac{\partial y}{\partial x} = \left(\frac{1}{2\sqrt{kt}}\right) \left(\frac{2}{\sqrt{\pi}} e^{-z^2}\right) = \frac{1}{\sqrt{\pi kt}} e^{-z^2},$$

and

$$k \frac{\partial^2 y}{\partial x^2} = k \left(\frac{1}{2\sqrt{kt}}\right) \left(-\frac{2z}{\sqrt{\pi kt}} e^{-z^2}\right) = -\frac{z}{\sqrt{\pi}t} e^{-z^2} = \frac{\partial y}{\partial t}.$$

21.

$$\frac{dy}{dx} = c_1 \frac{d}{dx} \operatorname{Ai}(x) + c_2 \frac{d}{dx} \operatorname{Bi}(x)$$

and

$$\frac{d^2 y}{dx^2} = c_1 \frac{d^2}{dx^2} \operatorname{Ai}(x) + c_2 \frac{d^2}{dx^2} \operatorname{Bi}(x) = c_1 x \operatorname{Ai}(x) + c_2 x \operatorname{Bi}(x) = xy.$$

Section 2.5

1.

	Approximation	Solution	Error
t	$\Delta t = 0.1$	$y(t)$	$\Delta t = 0.1$
0.1	2.000	2.010	0.010
0.2	2.020	2.037	0.017
0.3	2.058	2.082	0.024
0.4	2.112	2.141	0.029

3.

	Approximation			Solution	Error		
t	Δt			$y(t)$	Δt		
	0.02	0.01	0.005		0.02	0.01	0.005
0.1	5.206	5.234	5.248	5.263	0.057	0.029	0.015
0.4	16.45	19.34	21.61	25.00	8.55	5.64	3.39

Halving the step size reduces the error by about one half at $t=0.1$; the improvement at $t=0.4$ is less. See Figure 15. The first plot is for step size 0.02, the next for step size 0.01, and the last graph is for step size 0.005. The approximations are the data points marked with squares.

Chapter 2: Basic Concepts and Techniques

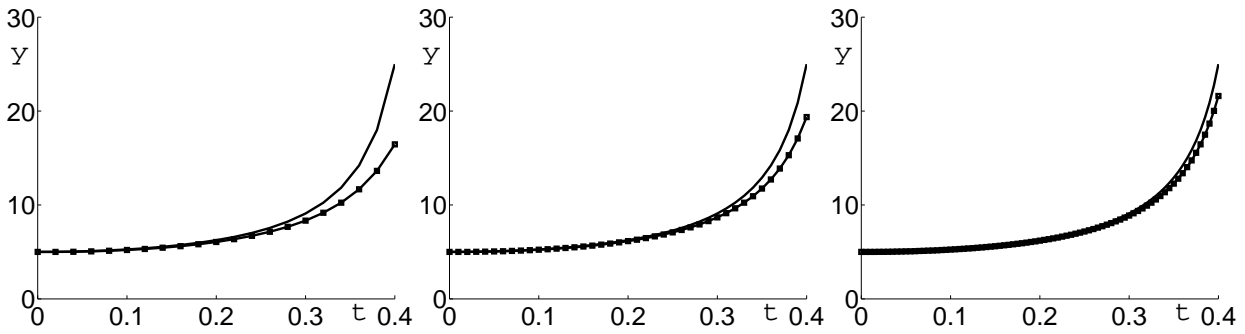

Figure 15: Exercise 2.5.3 with step sizes 0.02, 0.01 and 0.005 respectively.

5.

t	Approximation			Solution $y(t)$	Error		
	Δt	Δt	Δt		Δt	Δt	Δt
	0.2	0.1	0.05		0.2	0.1	0.05
2	3.571	3.514	3.486	3.459	0.112	0.055	0.027

The error is approximately cut in half if the step size is cut in half, with the error magnitude approximately $0.54\Delta t$. See Figure 16. The first plot is for step size 0.2, the second is for step size 0.1, and the last is for step size 0.05. The approximations are the data points marked with squares.

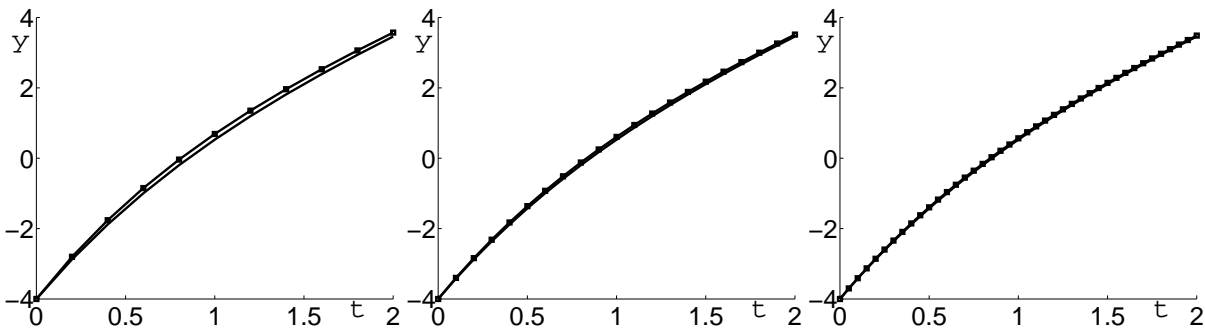

Figure 16: Exercise 2.5.5 with 10, 20 and 40 steps respectively.

7. See Figure 17.

t	Approximation			Solution $y(t)$	Error		
	Δt	Δt	Δt		Δt	Δt	Δt
	0.2	0.1	0.05		0.2	0.1	0.05
2	4.232	4.618	4.822	5.033	0.801	0.415	0.211

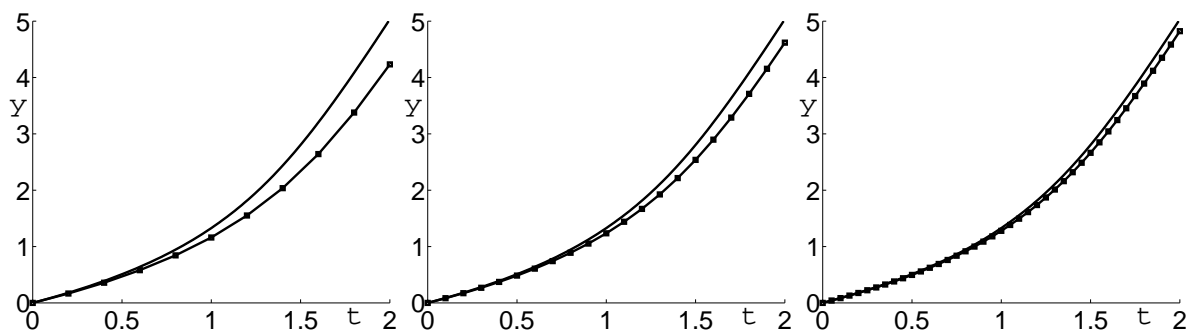

Figure 17: Exercise 2.5.7 with 10, 20 and 40 steps respectively.

9. The solution of the initial value problem is

$$y = \frac{1}{1 - \sin t}, \quad -\frac{3\pi}{2} < t < \frac{\pi}{2}.$$

The solution ceases to exist at $t = \pi/2$; however, the numerical approximation scheme always yields a finite slope at the points t_n . Therefore, the Euler approximation “jumps” across the line $t = \pi/2$ and begins to follow a different solution curve. See Figure 18.

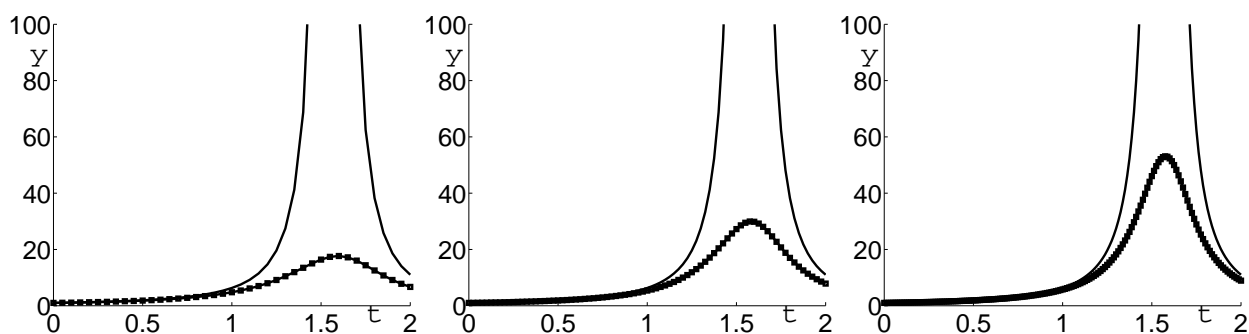

Figure 18: Exercise 2.5.9 with 40, 80 and 160 steps respectively.

11. (a) Euler’s method on the interval $[0, 1]$ estimates that the value of y for step size 0.025 when $t = 1$ is 0.4789.
- (b) Euler’s method on the interval $[0, 1]$ estimates that the value of y for step size 0.0125 when $t = 1$ is 0.4846.
- (c) Let y_a be the answer from part a and y_b be the answer from part b. The assumption on the error leads us to the equation $y(1) - y_a = 2(y(1) - y_b)$. If we solve for $y(1)$ we get $y(1) = 2y_b - y_a \approx 0.4903$. Of course this answer is not the exact value of $y(1)$, but it is the best answer that can be given from the available data.

Section 2.6

1.

t	Approximation			Solution	Error		
	Euler	Mod. Euler	rk4	$y(t)$	Euler	Mod. Euler	rk4
0.2	2.0200	2.0400		2.0374	0.0174	0.0026	
0.4	2.1122	2.1448	2.1408	2.1406	0.0286	0.0040	0.0002

Each approximation for $t = 0.2$ uses two evaluations of the derivative function, and each approximation for $t = 0.4$ uses four evaluations of the derivative function. The very large differences in accuracy are due to the differences in the methods.

3. (a)-(e)

t	Approximation			Solution	Error		
	Δt			$y(t)$	Δt		
	0.05	0.025	0.0125		0.05	0.025	0.0125
0.1	5.2613	5.2629	5.2631	5.2632	0.00187	0.00027	0.00004
0.4	21.70	23.74	24.61	25.00	3.30	1.26	0.39

For the modified Euler method, halving the step size reduces the error by about one-sixth at $t=0.1$; the error at $t=0.4$ is reduced by roughly one-third. (Theoretically, the error should be reduced by roughly one-quarter.) Given the same number of function evaluations, the modified Euler results are much better than the Euler results. See Figure 19.

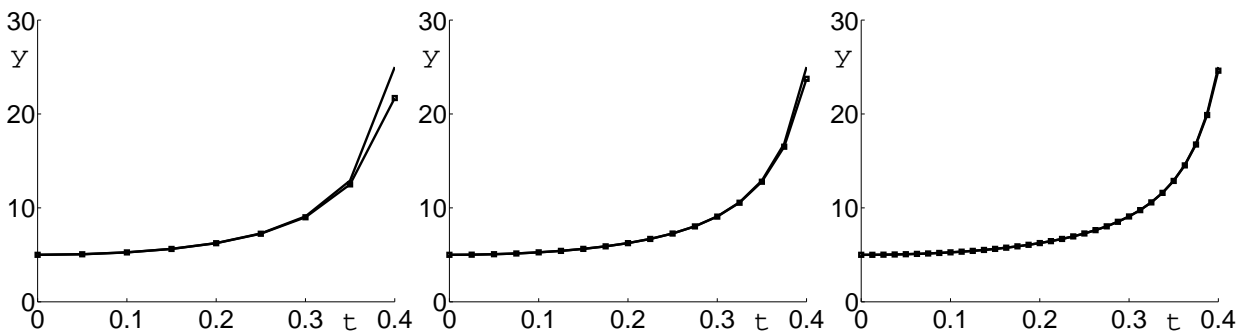

Figure 19: Exercise 2.6.3 with step size 0.05, 0.25, and 0.0125 respectively

(f)

t	Approximation		Solution $y(t)$	Error	
	Δt			Δt	
	0.1	0.05		0.1	0.05
0.1	5.26320	5.26316	5.26316	4.6×10^{-5}	3.4×10^{-6}
0.4	24.13	24.87	25.00	0.87	0.13

Halving the step size reduces the error by about one-fourteenth at $t=0.1$; the error at $t=0.4$ is reduced by roughly one-sixth. (Theoretically, the error should be reduced by roughly one-eighth.)

5. The Modified Euler and rk4 methods are better at tracking the sudden increase in slope as $t \rightarrow \pi/2$ and roughly comparable to each other. Neither is able to identify that the solution does not exist for $t \geq \pi/2$. See Figures 20 and 21.

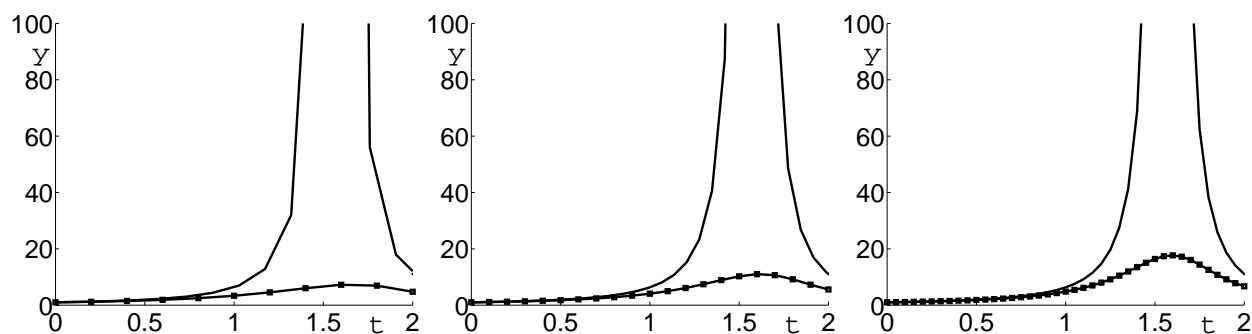

Figure 20: Exercise 2.6.5c with 20, 40, and 80 steps respectively

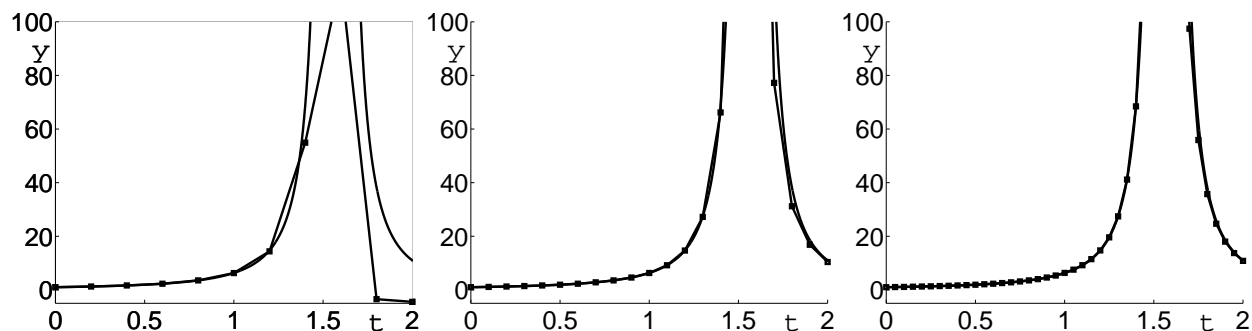

Figure 21: Exercise 2.6.5e with 20, 40, and 80 steps respectively

Chapter 2: Basic Concepts and Techniques

7. Increasing the heat liberated by the reaction makes the reaction accelerate faster and approach completion earlier. The following graphs are generated using rk4 with a step size of 0.001 and 2000 steps. See Figures 22 and 23.

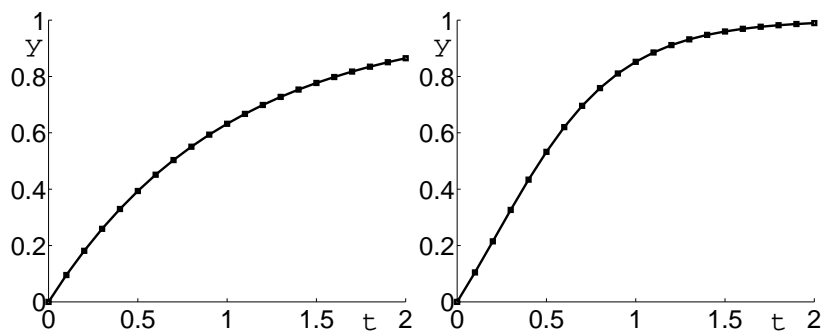

Figure 22: Exercise 2.6.7 with $\beta = 0$ and $\beta = 1$ respectively.

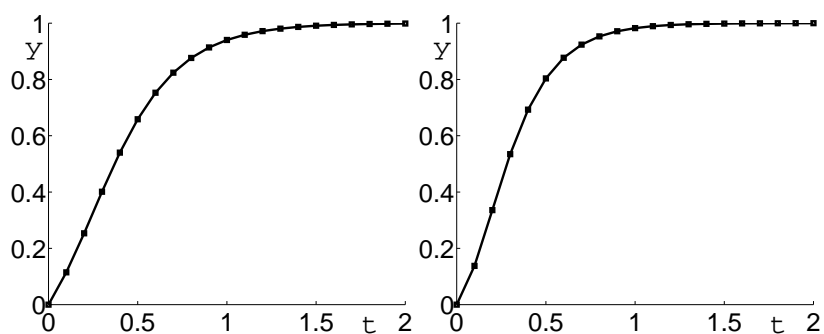

Figure 23: Exercise 2.6.7 with $\beta = 2$ and $\beta = 4$ respectively.

Section 3.1

1. The solution is $y = c_1 \cos t + c_2 \sin t$. The initial conditions imply $y = -\cos t - \sqrt{3} \sin t$. The amplitude is 2 and the phase shift is $\delta = 4\pi/3$. Thus, $y = 2 \cos(t - 4\pi/3)$. See Figure 24.

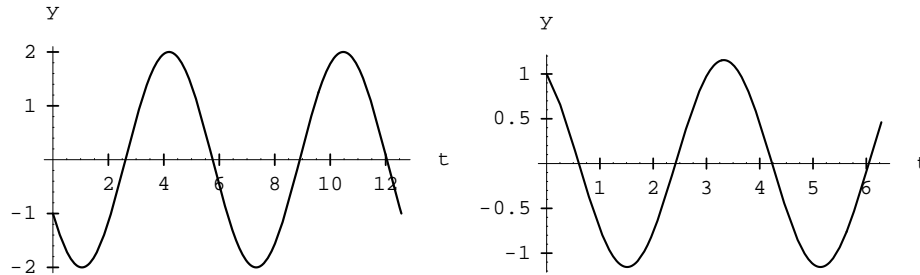

Figure 24: Exercises 3.1.1 and 3.1.3

3. The solution is $y = c_1 \cos \sqrt{3}t + c_2 \sin \sqrt{3}t$. The initial conditions imply $y = \cos \sqrt{3}t - \frac{1}{\sqrt{3}} \sin \sqrt{3}t$. The amplitude is $2/\sqrt{3}$ and the phase shift is $\delta = -\pi/6$. Thus, $y = \frac{2}{\sqrt{3}} \cos(\sqrt{3}t + \pi/6)$. See Figure 24.
5. The solution is $y = c_1 \cos \sqrt{5}t + c_2 \sin \sqrt{5}t$. The initial conditions imply $y = -2 \cos \sqrt{5}t - \frac{6}{\sqrt{5}} \sin \sqrt{5}t$. The amplitude is $\sqrt{56/5}$ and the phase shift is $\delta = \pi - \arcsin(-3/\sqrt{14})$. Thus, $y = \sqrt{\frac{56}{5}} \cos(\sqrt{5}t - \delta)$. See Figure 25.

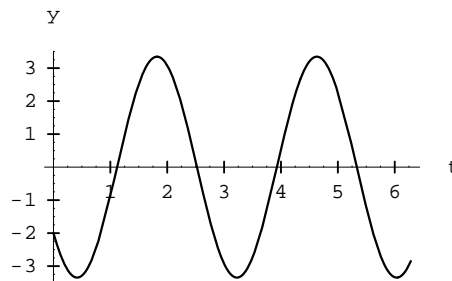

Figure 25: Exercise 3.1.5

7. The spring is governed by $y'' + 0.1ky = 0$, where k is the spring constant. Thus $y = c_1 \cos \sqrt{0.1k}t + c_2 \sin \sqrt{0.1k}t$. The period of motion is $2\pi\sqrt{10/k}$. Since this must be 1, $k = 40\pi^2$. Any resulting oscillation will always be of period 1.
9. The spring is governed by $my'' + ky = 0$, where m is the mass and k is the spring constant. Thus $y = c_1 \cos \sqrt{k/m}t + c_2 \sin \sqrt{k/m}t$. The information about the period tells us that $5\sqrt{k} = 2\pi\sqrt{m}$. Adding two pounds to the end of the spring gives us the equation $(m + 1/16)y'' + ky = 0$, where m is the original mass and k is the spring constant. Thus $y = c_1 \cos \sqrt{k/(m + 1/16)}t + c_2 \sin \sqrt{k/(m + 1/16)}t$. The information about the period tells us that $7\sqrt{k} = 2\pi\sqrt{(m + 1/16)}$. Eliminating k and solving for m in these two equations yields $m = 25/(16 \cdot 24) \approx 0.065$.

Chapter 3: Homogeneous Linear Equations

11. The spring constant is $k = 4 \cdot 980$. Thus we have $y'' + 196y = 0$. The solution is $y = c_1 \cos 14t + c_2 \sin 14t$. The initial conditions $y(0) = -2$ and $y'(0) = -1$ result in the solution

$$y = -2 \cos 14t - \frac{1}{14} \sin 14t.$$

The period is $\pi/7$ and the amplitude is $A = \sqrt{785}/14$. From $\cos \delta = -28/\sqrt{785}$ and $\sin \delta = -1/\sqrt{785}$, we have $\delta = \pi - \arcsin(-1/\sqrt{785}) \approx 3.177$.

13. The mass is $m = w/g = 1/16$ and the spring constant is $k = w/\Delta L = 4$, so the governing equation is $y'' + 64y = 0$. The initial conditions are $y(0) = 1/4$ and $y'(0) = 1$, and the corresponding solution is

$$y = \frac{1}{4} \cos 8t + \frac{1}{8} \sin 8t.$$

The amplitude is $A = \sqrt{5}/8$ and the phase shift is $\delta = \arcsin(1/\sqrt{5})$. See Figure 26.

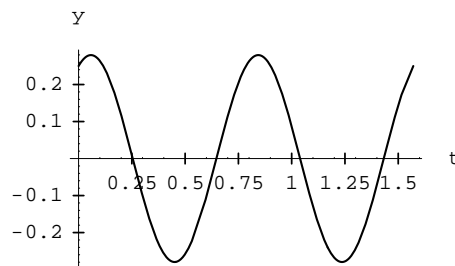

Figure 26: Exercise 3.1.13

15. (a) The linear approximation of $\sin \theta$ near $\theta = 0$ is $\sin \theta \approx \theta$. Thus $\theta'' + \frac{g}{L}\theta = 0$, from which we can immediately identify the period as $2\pi\sqrt{L/g}$.
- (b) We can multiply the equation by $2d\theta/dt$ to obtain

$$2\frac{d\theta}{dt} + \frac{2g}{L}\frac{d\theta}{dt}\sin \theta = 0.$$

Integrating both sides of this equation yields $(d\theta/dt)^2 - (2g/L)\cos \theta = C$. The initial conditions combine to yield $C = -(2g/L)\cos A$; we therefore arrive at the equation

$$\left(\frac{d\theta}{dt}\right)^2 = \frac{2g}{L}(\cos \theta - \cos A).$$

- (c) The right side of the equation of part (b) is positive as θ decreases from A to 0, so the equation makes sense. We choose the negative square root since θ is decreasing. We also know that $\theta = A$ when $t = 0$ and $\theta = 0$ when $t = T/4$. From part (a), the linear period is $T_0 = 2\pi\sqrt{L/g}$, so we have F defined by $T = 2\pi\sqrt{L/g}F$. Combining this information yields the problem

$$\frac{dt}{d\theta} = -\sqrt{\frac{L}{2g}} \frac{1}{\sqrt{\cos \theta - \cos A}}, \quad t(A) = 0, \quad t(0) = \frac{\pi}{2} \sqrt{\frac{L}{g}} F.$$

- (d) Multiplying the differential equation $dt/d\theta = G(\theta)$ by $d\theta$ and integrating over the interval $0 \leq \theta \leq A$ yields $\int_{t(0)}^{t(A)} dt = \int_0^A G(\theta) d\theta$. Using the function G and values $t(0)$ and $t(A)$ from part (c) yields, after simplification,

$$F = \frac{\sqrt{2}}{\pi} \int_0^A \frac{d\theta}{\sqrt{\cos \theta - \cos A}}.$$

- (e) Let $x = \cos \theta$. Then $dx = -\sin \theta d\theta = -\sqrt{1-x^2} d\theta$. The limits of integration become $x = 1$ and $x = \cos A$. We therefore have

$$F = \frac{\sqrt{2}}{\pi} \int_b^1 \frac{dx}{\sqrt{x-b} \sqrt{1-x^2}}, \quad b = \cos A.$$

- (f) As of this writing, Maple 9.5 has a bug in its “assume” command. The statement “assume($b > 0, b < 1$); getassumptions b ;” yields the output “{ $b::\text{RealRange}(-\infty, \text{Open}(1))$ }”, which is wrong. Instead, it is necessary to use “assume($b, \text{RealRange}(\text{Open}(0), \text{Open}(1))$);”. Once this has been done correctly, the formula for F from part (e) yields the response

$$F := \frac{2\text{EllipticK}\left(\frac{\sqrt{2-2b}}{2}\right)}{\pi}$$

Mathematica returns a long solution that includes hypergeometric functions as well as elliptic functions. In general, computer algebra systems have a lot of predefined functions, some of which only specialists would recognize. This really doesn't make any difference, as the integrals can always be calculated numerically. Numerical calculation is preferable for those cases where the predefined function is slow to compute. Whenever you get a messy formula, it is always a good idea to obtain graphs using both the formula and numerical approximation; if the results are different, it becomes necessary to determine which is correct.

- (g) We have $A = \pi a/180$ and $b = \cos(\pi a/180)$ along with the integral of part (e) or the formula of part (f). See Figure 27.

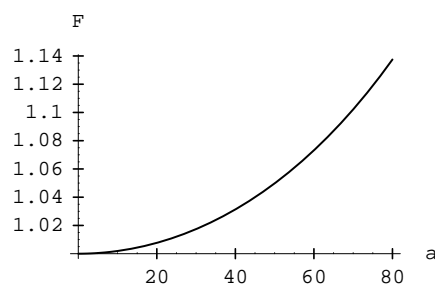

Figure 27: Exercise 3.1.15

Section 3.2

1.

$$\left(\begin{array}{ccc|c} 2 & 3 & -4 & -8 \\ 1 & -2 & -2 & -4 \\ 1 & 3 & 0 & 2 \end{array} \right) \cong \left(\begin{array}{ccc|c} 1 & 3/2 & -2 & -4 \\ 0 & 1 & 0 & 0 \\ 0 & 0 & 1 & 3 \end{array} \right) \cong \left(\begin{array}{ccc|c} 1 & 0 & 0 & 2 \\ 0 & 1 & 0 & 0 \\ 0 & 0 & 1 & 3 \end{array} \right)$$

Therefore, $x = 2$, $y = 0$, $z = 3$ is the unique solution.

Chapter 3: Homogeneous Linear Equations

3.

$$\left(\begin{array}{ccc|c} 2 & 1 & -2 & 10 \\ 3 & 2 & 2 & 1 \\ 5 & 4 & 3 & 4 \end{array} \right) \cong \left(\begin{array}{ccc|c} 1 & 1/2 & -1 & 5 \\ 0 & 1 & 10 & -28 \\ 0 & 0 & 1 & 3 \end{array} \right) \cong \left(\begin{array}{ccc|c} 1 & 0 & 0 & 1 \\ 0 & 1 & 0 & 2 \\ 0 & 0 & 1 & -3 \end{array} \right)$$

Therefore, $x = 1$, $y = 2$, $z = -3$ is the unique solution.

5.

$$\left(\begin{array}{ccc|c} 2 & 6 & 1 & 8 \\ 1 & 2 & -1 & -2 \\ 5 & 7 & -4 & 5 \end{array} \right) \cong \left(\begin{array}{ccc|c} 1 & 3 & 1/2 & 4 \\ 0 & 1 & 3/2 & 6 \\ 0 & 0 & 1 & 6 \end{array} \right) \cong \left(\begin{array}{ccc|c} 1 & 0 & 0 & 10 \\ 0 & 1 & 0 & -3 \\ 0 & 0 & 1 & 6 \end{array} \right)$$

Therefore, $x = 10$, $y = -3$, $z = 6$ is the unique solution.

7.

$$\left(\begin{array}{ccc|c} 1 & -2 & 3 & -7 \\ 4 & 3 & 1 & 5 \\ 2 & 7 & -5 & 19 \end{array} \right) \cong \left(\begin{array}{ccc|c} 1 & -2 & 3 & -7 \\ 0 & 11 & -11 & 33 \\ 0 & 11 & -11 & 33 \end{array} \right)$$

The matrix is singular, so there cannot be a unique solution.

9.

$$\left(\begin{array}{cccc|c} 1 & 1 & -1 & 0 & -1 \\ 1 & 1 & 1 & 1 & 2 \\ -1 & 1 & 0 & 1 & 1 \\ 1 & 0 & 2 & 1 & 3 \end{array} \right) \cong \left(\begin{array}{cccc|c} 1 & 1 & -1 & 0 & -1 \\ 0 & 1 & -3 & -1 & -4 \\ 0 & 0 & 1 & 3/5 & 8/5 \\ 0 & 0 & 0 & 1 & 1 \end{array} \right) \cong \left(\begin{array}{cccc|c} 1 & 0 & 0 & 0 & 0 \\ 0 & 1 & 0 & 0 & 0 \\ 0 & 0 & 1 & 0 & 1 \\ 0 & 0 & 0 & 1 & 1 \end{array} \right)$$

Therefore, $w = 0$, $x = 0$, $y = 1$, $z = 1$ is the unique solution.

11.

$$\begin{vmatrix} 0 & 3 & 2 \\ 1 & 0 & 4 \\ -1 & 0 & -3 \end{vmatrix} = -3 \begin{vmatrix} 1 & 4 \\ -1 & -3 \end{vmatrix} = -3(-3 + 4) = -3.$$

13.

$$\begin{vmatrix} 2 & 0 & 3 \\ 1 & 7 & 2 \\ 4 & 6 & 2 \end{vmatrix} = 2 \begin{vmatrix} 7 & 2 \\ 6 & 2 \end{vmatrix} + 3 \begin{vmatrix} 1 & 7 \\ 4 & 6 \end{vmatrix} = -62.$$

15.

$$\begin{vmatrix} 1 & -2 & 1 & 2 \\ 4 & 0 & 5 & 0 \\ 0 & 1 & 6 & 1 \\ 1 & 1 & -1 & 5 \end{vmatrix} = \begin{vmatrix} 1 & 0 & 13 & 4 \\ 4 & 0 & 5 & 0 \\ 0 & 1 & 6 & 1 \\ 1 & 0 & -7 & 4 \end{vmatrix} = - \begin{vmatrix} 1 & 13 & 4 \\ 4 & 5 & 0 \\ 1 & -7 & 4 \end{vmatrix} = - \begin{vmatrix} 0 & 20 & 0 \\ 4 & 5 & 0 \\ 1 & -7 & 4 \end{vmatrix} \\ = 20 \begin{vmatrix} 4 & 0 \\ 1 & 4 \end{vmatrix} = 320.$$

17. Ignoring the value of c for the moment, we have

$$\left(\begin{array}{c|c} 1 & 1 \\ 2 & c \end{array} \middle| \begin{array}{c} 3 \\ 7 \end{array} \right) \cong \left(\begin{array}{c|c} 1 & 1 \\ 0 & c-2 \end{array} \middle| \begin{array}{c} 3 \\ 1 \end{array} \right).$$

The matrix is singular if $c = 2$. Otherwise, we can easily solve the decoupled system that remains:

$$y = \frac{1}{c-2}, \quad x = 3 - y = \frac{3c-7}{c-2}.$$

19. Ignoring the value of c for the moment, we have

$$\begin{aligned} \left(\begin{array}{ccc|c} 1 & 2 & 1 & 4 \\ 2 & 0 & -3 & 6 \\ 0 & c & 4 & 0 \end{array} \right) &\cong \left(\begin{array}{ccc|c} 1 & 2 & 1 & \\ 0 & -4 & -5 & \\ 0 & c & 4 & \end{array} \right) \cong \left(\begin{array}{ccc|c} 1 & 0 & -3/2 & 3 \\ 0 & 1 & 5/4 & 1/2 \\ 0 & 0 & \frac{16-5c}{4} & -c/2 \end{array} \right) \\ &\cong \left(\begin{array}{ccc|c} 1 & 0 & -3/2 & 3 \\ 0 & 1 & 5/4 & 1/2 \\ 0 & 0 & 16-5c & -2c \end{array} \right). \end{aligned}$$

The matrix is singular if $c = 16/5$. Otherwise, we can easily solve the decoupled system that remains:

$$z = \frac{-2c}{16-5c}, \quad y = \frac{1}{2} - \frac{5}{4}z = \frac{8}{16-5c}, \quad x = 3 + \frac{3}{2}z = \frac{48-18c}{16-5c}.$$

21. The augmented matrix is

$$\left(\begin{array}{cc|c} 1 & -3 & 0 \\ 2 & -6 & 0 \end{array} \right) \cong \left(\begin{array}{cc|c} 1 & -3 & 0 \\ 0 & 0 & 0 \end{array} \right).$$

The system reduces to the single equation $x - 3y = 0$, so a one-parameter family of solutions is $x = 3c$, $y = c$.

Section 3.3

1. $y = t^3 - t$, $y' = 3t^2 - 1$, $y'' = 6t$, so $L[y] = 2t^2 + 4t$.
3. $y = e^{-t} \cos t$, $y' = -e^{-t} \cos t - e^{-t} \sin t$, $y'' = 2e^{-t} \sin t$, so $L[y] = 2e^{-t}(\sin t + \cos t)$.
5. $y = c_1 e^{-2t}$, $y' = -2c_1 e^{-2t}$, $y'' = 4c_1 e^{-2t}$, so $L[y] = 6c_1 e^{-2t}$.
7. $y = c_1 \cos 2t$, $y' = -2c_1 \sin 2t$, $y'' = -4c_1 \cos 2t$, so $L[y] = -6c_1 \sin 2t$.
9. Let $g = 2t^2 + 4t$; then $y = t^3 - t$ solves $L[y] = g$.
11. (a) $y_1 = 1$, $y_1' = 0$, $y_1'' = 0$, and $y_1''' = 0$. $y_2 = t$, $y_2' = 1$, $y_2'' = 0$, and $y_2''' = 0$. $y_3 = e^{2t}$, $y_3' = 2e^{2t}$, $y_3'' = 4e^{2t}$, and $y_3''' = 8e^{2t}$.
(b) $y = c_1 + c_2 t + c_3 e^{2t}$.
13. (a) $y_1 = e^t$, $y_1' = e^t$, and $y_1'' = e^t$. $y_2 = te^t$, $y_2' = e^t + te^t$, and $y_2'' = 2e^t + te^t$.
(b) $y = c_1 e^t + c_2 te^t$.
15. (a) $(-\infty, \infty)$.
(b) $y_1 = e^{-2t}$, $y_1' = -2e^{-2t}$, and $y_1'' = 4e^{-2t}$. $y_2 = e^{3t}$, $y_2' = 3e^{3t}$, and $y_2'' = 9e^{3t}$.
(c) $W = \begin{vmatrix} e^{-2t} & e^{3t} \\ -2e^{-2t} & 3e^{3t} \end{vmatrix} = 5e^t \neq 0$, so this is a linearly independent set of solutions.
(d) $W = 5e^t$ and $W' = 5e^t = W$.
(e) $y = c_1 e^{-2t} + c_2 e^{3t}$.
(f) The initial conditions yield $y = \frac{1}{5}(e^{3t} - e^{-2t})$.
(g) $(-\infty, \infty)$.

Chapter 3: Homogeneous Linear Equations

17. (a) $(0, \infty)$.
(b) $y_1 = x^2$, $y_1' = 2x$, and $y_1'' = 2$. $y_2 = x^2 \ln x$, $y_2' = 2x \ln x + x$, and $y_2'' = 2 \ln x + 3$.
(c) $W = \begin{vmatrix} x^2 & x^2 \ln x \\ 2x & 2x \ln x + x \end{vmatrix} = x^3 \neq 0$ on $(0, \infty)$, so this is a linearly independent set of solutions.
(d) $W = x^3$ and $W' = 3x^2 = \frac{3}{x}W$.
(e) $y = c_1x^2 + c_2x^2 \ln x$.
(f) The initial conditions yield $y = x^2 - 3x^2 \ln x$.
(g) $(0, \infty)$.
19. (a) $(-\infty, \infty)$.
(b) $y_1 = 1$, $y_1' = 0$, $y_1'' = 0$, and $y_1''' = 0$. $y_2 = t$, $y_2' = 1$, $y_2'' = 0$, and $y_2''' = 0$. $y_3 = e^{-2t}$, $y_3' = -2e^{-2t}$, $y_3'' = 4e^{-2t}$, and $y_3''' = -8e^{-2t}$.
(c) $W = \begin{vmatrix} 1 & t & e^{-2t} \\ 0 & 1 & -2e^{-2t} \\ 0 & 0 & 4e^{-2t} \end{vmatrix} = 4e^{-2t} \neq 0$, so this is a linearly independent set of solutions.
(d) $W = 4e^{-2t}$ and $W' = -8e^{-2t} = -2W$.
(e) $y = c_1 + c_2t + c_3e^{-2t}$.
(f) The initial conditions yield $y = 1$.
(g) $(-\infty, \infty)$.

Section 3.4

1. The characteristic polynomial is $r^2 + 4r + 3$. The characteristic values are $r = -1, -3$. The solution is $y = c_1e^{-t} + c_2e^{-3t}$.
3. The characteristic polynomial is $r^2 - 4$. The characteristic values are $r = 2, -2$. The solution is $y = c_1e^{2t} + c_2e^{-2t}$.
5. The characteristic polynomial is $r^3 + 5r^2 + 4r$. The characteristic values are $r = 0, -1, -4$. The solution is $y = c_1 + c_2e^{-t} + c_3e^{-4t}$.
7. The characteristic polynomial is $r^2 + 5r + 6$. The characteristic values are $r = -2, -3$. The general solution is $y = c_1e^{-2t} + c_2e^{-3t}$. The initial conditions give $y = 6e^{-2t} - 4e^{-3t}$. The long time approximation is $6e^{-2t}$. See Figure 28.
9. The characteristic polynomial is $r^2 + 2r - 8$. The characteristic values are $r = 2, -4$. The solution is $y = c_1e^{2t} + c_2e^{-4t}$. The initial conditions give $y = \frac{8}{3}e^{2t} + \frac{4}{3}e^{-3t}$. The long time approximation is $\frac{8}{3}e^{2t}$. See Figure 28.

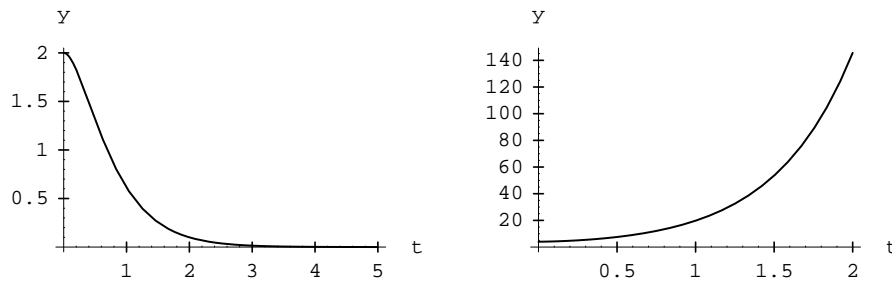

Figure 28: Exercises 3.4.7 and 3.4.9

11. (a) Given the equation $y'' + by' + 4y = 0$, the critical amount of damping occurs when there is exactly one characteristic value. The characteristic value is $r = (-b \pm \sqrt{b^2 - 16})/2$. This will have only one solution when $b = 4$.
- (b) We are considering the equation $y'' + 8y' + 4y = 0$, with $y(0) = 1$ and $y'(0) = 0$. The characteristic polynomial is $r^2 + 8r + 4$. The characteristic values are $r = -4 \pm 2\sqrt{3}$. The general solution is $y = c_1 e^{(-4+2\sqrt{3})t} + c_2 e^{(-4-2\sqrt{3})t}$. The initial conditions yield $y = \frac{3+3\sqrt{3}}{6} e^{(-4+2\sqrt{3})t} + \frac{3-2\sqrt{3}}{6} e^{(-4-2\sqrt{3})t}$.
- (c) For any initial conditions, the solution is $y = c_1 e^{(-4+2\sqrt{3})t} + c_2 e^{(-4-2\sqrt{3})t}$. We have $y = 1$ at time 0 and $y \approx c_1 e^{(-4+2\sqrt{3})t}$ as $t \rightarrow \infty$. The solution will reach 0 at a finite time if $c_1 < 0$. The critical case is where $c_1 = 0$. The solution is then $y = e^{(-4-2\sqrt{3})t}$, from which we have $y'(0) = -4 - 2\sqrt{3}$. The requirement is $s > 4 + 2\sqrt{3} \approx 7.46$.

Section 3.5

- The characteristic equation is $r^2 + 5 = 0$. The characteristic values are $r = \pm\sqrt{5}i$. The general solution is $y = c_1 \cos \sqrt{5}t + c_2 \sin \sqrt{5}t$.
- The characteristic equation is $r^2 - 4r + 8 = 0$. The characteristic values are $r = 2 \pm 2i$. The general solution is $y = e^{2t}(c_1 \cos 2t + c_2 \sin 2t)$.
- The characteristic equation is $r^3 - r = 0$. The characteristic values are $r = 0, \pm 1$. The general solution is $y = c_1 + c_2 e^t + c_3 e^{-t}$.
- The characteristic equation is $r^2 + 4r + 5 = 0$. The characteristic values are $r = -2 \pm i$. The general solution is $y = e^{-2t}(c_1 \cos t + c_2 \sin t)$. The initial conditions yield

$$y = e^{-2t}(2 \cos t + 4 \sin t).$$

The amplitude is $A = \sqrt{20}$, so the envelope is $\pm\sqrt{20}e^{-2t}$. See Figure 29.

- The characteristic equation is $r^2 + 2r + 6 = 0$. The characteristic values are $r = -1 \pm \sqrt{5}i$. The general solution is $y = e^{-t}(c_1 \cos \sqrt{5}t + c_2 \sin \sqrt{5}t)$. The initial conditions yield

$$y = \frac{2}{\sqrt{5}} e^{-t} \sin \sqrt{5}t.$$

The amplitude is $A = \frac{2}{\sqrt{5}}$, so the envelope is $\pm\frac{2}{\sqrt{5}}e^{-t}$. See Figure 29.

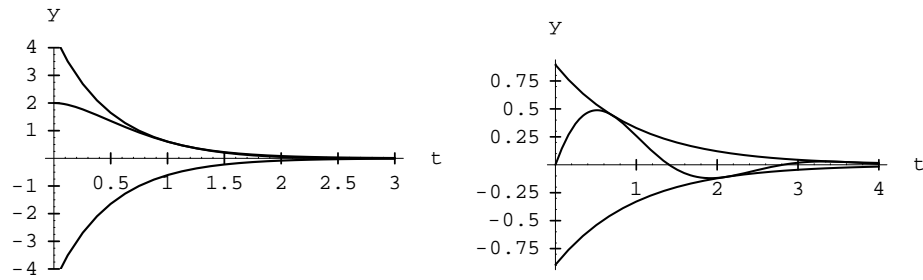

Figure 29: Exercises 3.5.7 and 3.5.9

11.

$$W[e^{\alpha} \cos \beta t, e^{\alpha} \sin \beta t] = \begin{vmatrix} e^{\alpha t} \cos \beta t & e^{\alpha t} \sin \beta t \\ \alpha e^{\alpha t} \cos \beta t - \beta e^{\alpha t} \sin \beta t & \alpha e^{\alpha t} \sin \beta t + \beta e^{\alpha t} \cos \beta t \end{vmatrix} = \beta e^{2\alpha t}.$$

13. Given the equation $y'' + by' + 4y = 0$, the critical amount of damping occurs when there is exactly one characteristic value. The characteristic value is $r = (-b \pm \sqrt{b^2 - 16})/2$. This will have only one solution when $b = 4$. We are considering the equation $y'' + 2y' + 4y = 0$, with $y(0) = 1$ and $y'(0) = 0$. The characteristic polynomial is $r^2 + 2r + 4$. The characteristic values are $r = -1 \pm \sqrt{3}i$. The general solution is $y = e^{-t}(c_1 \cos \sqrt{3} t + c_2 \sin \sqrt{3} t)$. The initial conditions yield

$$y = e^{-t} \left(\cos \sqrt{3} t + \frac{1}{\sqrt{3}} \sin \sqrt{3} t \right).$$

See Figure 30.

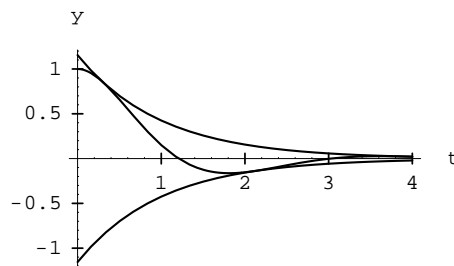

Figure 30: Exercise 3.5.13

Section 3.6

1. The characteristic polynomial is $r^2 - 4r + 4 = (r - 2)^2$. The characteristic value is $r = 2$. The general solution is $y = (c_1 + c_2 t)e^{2t}$. The initial conditions yield

$$y = (2 - 3t)e^{2t}.$$

3. The characteristic polynomial is $r^3 - 6r^2 + 13r = r(r^2 - 6r + 13)$. The characteristic values are $r = 0, 3 \pm 2i$. The general solution is $y = c_1 + e^{3t}(c_2 \cos 2t + c_3 \sin 2t)$. The initial conditions yield

$$y = 1 + 2e^{3t} \cos 2t.$$

5. Let $y_2 = e^x v(x)$. Then $y_2' = e^x(v' + v)$ and $y_2'' = e^x(v'' + 2v' + v)$. Substituting into the differential equation for y yields $xv'' - 2v' = 0$. A solution of this equation is $v = x^3$; thus, we have $y_2 = x^3 e^x$. The general solution is

$$y = c_1 e^x + c_2 x^3 e^x.$$

7. Let $y_2 = e^x v(x)$. Then $y_2' = e^x(v' + v)$ and $y_2'' = e^x(v'' + 2v' + v)$. Substituting into the differential equation for y yields $v'' - e^x v' = 0$. A solution of this equation is $v' = \exp(e^x)$; thus, we have $v = \int_0^x \exp(e^s) ds$ and $y_2 = e^x \int_0^x \exp(e^s) ds$. The general solution is

$$y = c_1 e^x + c_2 e^x \int_0^x \exp(e^s) ds.$$

9. Let $y_2 = x^{-1/2}(\sin x)v(x)$. Then $y_2' = (x^{-1/2} \sin x)v' + (x^{-1/2} \cos x - \frac{1}{2}x^{-3/2} \sin x)v$ and $y_2'' = (x^{-1/2} \sin x)v'' + (2x^{-1/2} \cos x - x^{-3/2} \sin x)v' + [-x^{-3/2} \cos x + (\frac{3}{4}x^{-5/2} - x^{-1/2}) \sin x]v$. Substituting into the differential equation for y yields $(\sin x)v'' + 2(\cos x)v' = 0$. A solution of this equation is $v' = -\csc^2 x$; thus, we have $v' = \cot x$ and $y_2 = x^{-1/2} \cos x$. The general solution is

$$y = c_1 x^{-1/2} \sin x + c_2 x^{-1/2} \cos x.$$

11. Let $y_2 = e^{x^2} v(x)$. Then $y_2' = e^{x^2} v' + 2xe^{x^2} v$ and $y_2'' = e^{x^2} v'' + 4xe^{x^2} v' + (8x^2 + 4)e^{x^2} v$. Substituting into the differential equation for y yields $v'' + 2xv' = 0$. A solution of this equation is $v = \int_0^x e^{-s^2} ds$; thus, we have $y_2 = e^{x^2} \operatorname{erf}(x)$. The general solution is

$$y = c_1 e^{x^2} + c_2 \operatorname{erf}(x).$$

13. Let $y = e^{-t} v(t)$. Then $y_2' = e^{-t}(v' - v)$, $y_2'' = e^{-t}(v'' - 2v' + v)$, and $y_2''' = e^{-t}(v''' - 3v'' + 3v' - v)$. Substituting into the differential equation for y yields $v''' = 0$; thus, we have $v = c_1 + c_2 t + c_3 t^2$. The general solution is

$$y = (c_1 + c_2 t + c_3 t^2)e^{-t}.$$

Section 3.7

1. Let $x = e^t$. The differential equation in terms of t is $2y'' - y' - 3y = 0$. The characteristic equation is $2r^2 - r - 3 = 0$. The characteristic values are $r = \frac{3}{2}, -1$. The general solution is $y = c_1 e^{3t/2} + c_2 e^{-t} = c_1 x^{3/2} + c_2 x^{-1}$. The initial conditions yield $y = 2x^{3/2} - x^{-1}$. As $x \rightarrow 0$ the solution behaves like $1/x$. See Figure 31.
3. Let $x = -e^t$. The differential equation in terms of t is $y'' - 4y' + 4y = 0$. The characteristic equation is $r^2 - 4r + 4 = 0$. The characteristic values are $r = 2$. The general solution is $y = (c_1 + c_2 t)e^{2t} = c_1 x^2 + c_2 x^2 \ln(-x)$. The initial conditions yield $y = 2x^2 + 7x^2 \ln(-x)$. As $x \rightarrow 0$ the solution behaves like $7x^2 \ln(-x)$. See Figure 31.

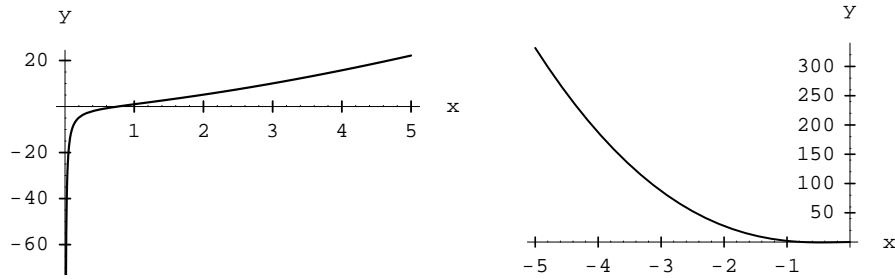

Figure 31: Exercises 3.7.1 and 3.7.3

5. Let $y = x^r$. Then the differential equation becomes $r^2 - r + \beta = 0$. The solution of this is $r = (\frac{1}{2} \pm \sqrt{1 - 4\beta})/2$. In order for the solution to vanish as $x \rightarrow 0$, we need the real part of r to be positive for both roots. If $1 - 4\beta \leq 0$, this is always true. If $1 - 4\beta > 0$, we need $1 - \sqrt{1 - 4\beta} > 0$ which implies $\beta > 0$. Thus we need $\beta > 0$.
7. We begin with the equation $m \frac{d^2 y}{dt^2} + b \frac{dy}{dt} + ky = 0$. Then $\frac{dy}{dt} = \sqrt{k/m} \frac{dy}{dr}$ and $\frac{d^2 y}{dt^2} = (k/m) \frac{d^2 y}{dr^2}$. Substituting these and the expression for β into the equation, we get $y'' + 2\beta y' + y = 0$. β is the damping coefficient relative to the critical damping value.
9. (a) With $\lambda = 0$, the equation is $r^2 \frac{d^2 y}{dr^2} + r \frac{dy}{dr} - \nu^2 y = 0$. The guess $y = r^m$ yields the characteristic equation $m^2 = \nu^2$. The solution is $y = c_1 r^\nu + c_2 r^{-\nu}$ if $\nu \neq 0$ and $y = c_1 + c_2 \ln r$ if $\nu = 0$.
- (b) Let $x = \lambda r$. The equation becomes $x^2 \frac{d^2 y}{dx^2} + x \frac{dy}{dx} + (x^2 - \nu^2)y = 0$. The solution of this is $y = c_1 J_\nu(x) + c_2 Y_\nu(x) = c_1 J_\nu(\lambda r) + c_2 Y_\nu(\lambda r)$.
11. Let $y = x^r f$. Then $y' = r x^{r-1} f + x^r f'$ and $y'' = r(r-1)x^{r-2} f + 2r x^{r-1} f' + x^r f''$. Substituting these into the equation yields

$$x^2 f'' + (2r - 1)x f' + (x^2 + r^2 - 2r)f = 0.$$

For this to be an equation of Bessel type, the coefficient of f' must be x . Thus $r = 1$. The equation is then a Bessel equation with $\nu = 1$. Thus $f = c_1 J_1(x) + c_2 Y_1(x)$ and $y = c_1 x J_1(x) + c_2 x Y_1(x)$.

Section 4.1

1. We must solve the equation $0.001v' + v = 1.5$. Let $y = v - 1.5$. Then $y' + 1000y = 0$ and $y(0) = -1.5$. The solution of this problem is $y = -1.5e^{-1000t}$. Therefore, $v = 1.5 - 1.5e^{-1000t}$. The current is

$$i = 10^{-3}y' = 1.5e^{-1000t}.$$

3. We must solve the equation $0.04v'' + 0.4v' + v = 10$. Let $y = v - 10$. Then $y'' + 10y' + 25y = 0$, $y(0) = -10$, and $y'(0) = 0$. The solution of this problem is $y = (-50t - 10)e^{-5t}$. Therefore, $v = 10 + (-50t - 10)e^{-5t}$. The current is

$$i = 0.01y' = 250te^{-5t}.$$

5. We must solve the equation $v'' + 0.2v' + v = 20$. Let $y = v - 20$. Then $y'' + 0.2y' + y = 0$, $y(0) = 0$, and $y'(0) = 100i(0) = 100$. The solution of this problem is $y = 100\beta^{-1}e^{-0.1t} \sin \beta t$, where $\beta = \sqrt{0.99} \approx 1$. Therefore, $v = 20 + 100\beta^{-1}e^{-0.1t} \sin \beta t$. The current is

$$i = 0.01y' = e^{-0.1t}(\cos \beta t - 0.1\beta^{-1} \sin \beta t).$$

7. (a) $Li' + Ri = E, i(0) = i_0$.

(b) Let $k = E/R$ and $y = i - k$. The problem becomes $Ly' + Ry = 0$ with $y(0) = i_0 - k$.

(c) The solution of this problem is $y = (i_0 - k)e^{-Rt/L}$.

(d) $i = \frac{E}{R} + \left(i_0 - \frac{E}{R}\right)e^{-Rt/L}$.

(e) The steady state current is E/R .

(f) Without the capacitor there will be no oscillations in current. If the capacitor is added then the steady state solution for the current must be zero.

9. (a) When the switch is closed, we have an RL series circuit with $R = 2.6$, $L = 0.0058$, and $E = 12$. The initial condition is $i_0 = 0$. By Exercise 7, we have $i = (E/R)(1 - e^{-RT/L}) \approx 4.615(1 - e^{-448t})$ and $v_L = Li' = Ee^{-RT/L} \approx 12e^{-448t}$. Note that the current approaches E/R as $t \rightarrow \infty$; also, v_R approaches E and v_L approaches 0.

(b) When the switch is opened, we have an RLC series circuit with $R = 2.6$, $L = 0.0058$, $C = 0.0005$, and $E = 12$. The initial conditions are $v(0) = E - v_R(0) - v_L(0) = 0$ and $v'(0) = C^{-1}i(0) = E/(RC)$. We therefore have (approximately) the initial value problem

$$0.0000029v'' + 0.01508v' + v = 12, \quad v(0) = 0, \quad v'(0) = 796.$$

The solution of this problem is $v = 12 + e^{-224t}(497 \sin 18568t - 12 \cos 18568t)$. From $v_L = Lv''$, we obtain

$$v_L \approx -497e^{-224t} \sin 18568t.$$

(c) Most of the time, the switch is open and the voltage drifts from 12 down to 0. When the switch is closed, the voltage becomes $-497e^{-224t} \sin 18568t$. The amplitude of the oscillation is given by the envelope $\pm 497e^{-224t}$. This means that closing the switch almost immediately causes an oscillating voltage of amplitude almost 500 volts. This spike is further amplified in the ignition coil, creating an enormous static charge at the spark plug gap. This charge jumps the gap, somewhat like a miniature bolt of lightning. The switch opens very quickly, reducing the voltage in the primary coil back to 12.

Chapter 4: Nonhomogeneous Linear Equations

11. (a) The system is critically damped when $L_0 = 1$.
 (b) We have the problem $Lv'' + 2v' + v = 1$, with $v(0) = 0$ and $v'(0) = 0$. Setting $y = v - 1$, we have $Ly'' + 2y' + y = 0$, with $y(0) = -1$ and $y'(0) = 0$. For the overdamped $L = 0$ case, we have $v = 1 - e^{-t/2}$ and $i = \frac{1}{2}e^{-t/2}$. The other cases are underdamped, and we obtain

$$y = -e^{-t/L} \left(\cos \frac{\sqrt{L-1}}{L} t + \frac{1}{\sqrt{L-1}} \sin \frac{\sqrt{L-1}}{L} t \right).$$

Then $i = y'$ yields

$$i = \frac{1}{\sqrt{L-1}} e^{-t/L} \sin \frac{\sqrt{L-1}}{L} t.$$

- (c) See Figure 32.

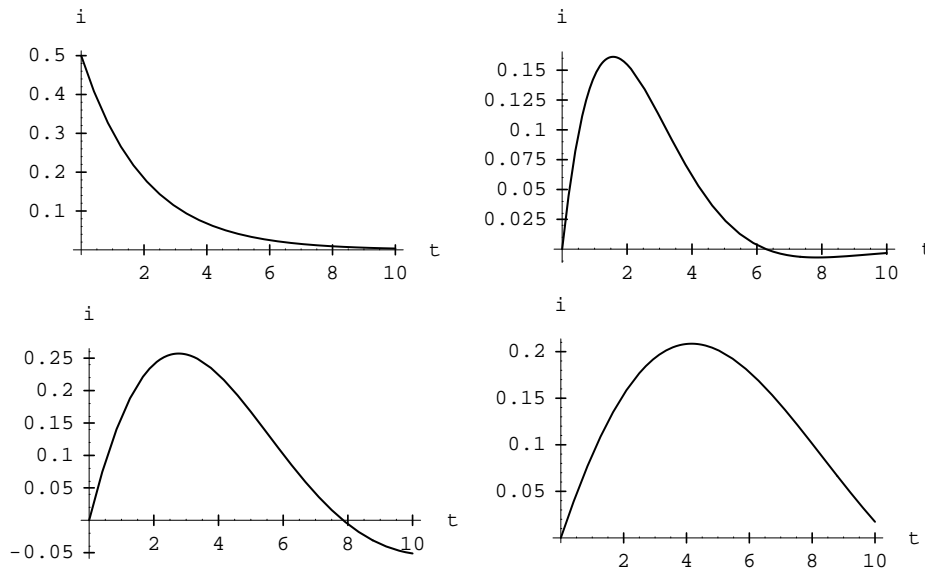

Figure 32: Exercise 4.1.11

- (d) Increasing inductance is like increasing the mass in a spring-mass model. When inductance is above the critical value, the circuit is underdamped. Increasing L speeds up the oscillation and slows down the envelope decay. Below the critical value, the circuit is overdamped and further decrease in L slows down the solution decay.

Section 4.2

1. The characteristic values of L are $\lambda = \pm 2$, so the complementary solution is $y_c = c_1 e^{2t} + c_2 e^{-2t}$. Using the trial solution $y = Ae^t$, we obtain $A = -\frac{1}{3}$. Therefore,

$$y = -\frac{1}{3}e^t + c_1 e^{2t} + c_2 e^{-2t}.$$

3. The characteristic value of L is $\lambda = -3$, so the complementary solution is $y_c = (c_1 + c_2 t)e^{-3t}$. Using the trial solution $y = Ae^{2t}$, we obtain $A = \frac{1}{25}$. Therefore,

$$y = \frac{1}{25}e^{2t} + (c_1 + c_2 t)e^{-3t}.$$

5. The characteristic value of L is $\lambda = -4$, so the complementary solution is $y_c = ce^{-4t}$. Using the trial solution $y = A \cos 3t + B \sin 3t$, we obtain $A = \frac{4}{25}$ and $B = \frac{3}{25}$. Therefore,

$$y = \frac{4}{25} \cos 3t + \frac{3}{25} \sin 3t + ce^{-4t}.$$

7. The characteristic values of L are $\lambda = \pm 2i$, so the complementary solution is $y_c = c_1 \cos 2t + c_2 \sin 2t$. Using the trial solution $y = A \sin 3t + B \cos 3t$, we obtain $A = -\frac{1}{5}$ and $B = 0$. Therefore,

$$y = -\frac{1}{5} \sin 3t + c_1 \cos 2t + c_2 \sin 2t.$$

9. The characteristic value of L is $\lambda = -2$, so the complementary solution is $y_c = ce^{-2t}$. Using the trial solution $y = Ae^t$, we obtain $A = 1$. Using the initial condition yields

$$y = e^t + 2e^{-2t}.$$

11. The characteristic value of L is $\lambda = -5$, so the complementary solution is $y_c = ce^{-5t}$. Using the trial solution $y = A \cos 2t + B \sin 2t$, we obtain $A = -\frac{6}{29}$ and $B = \frac{15}{29}$. Using the initial condition yields

$$y = -\frac{6}{29} \cos 2t + \frac{15}{29} \sin 2t + \frac{93}{29} e^{-5t}.$$

13. (a) Since, $y_p = A \cos 2t + B \sin 2t$, $y'_p = -2A \sin 2t + 2B \cos 2t$. Substituting these into the equation and solving yields $y = \frac{5}{13} \cos 2t - \frac{1}{13} \sin 2t$.
 (b) This cannot be done.
 (c) The appropriate trial solution is $y = A \cos 2t + B \sin 2t + C \cos 4t + D \sin 4t$. Substituting this into the equation and matching coefficients yields $y = \frac{3}{13} \cos 2t + \frac{2}{13} \sin 2t + \frac{4}{25} \cos 4t - \frac{3}{25} \sin 4t$.

15. (a) 2.
 (b) $1 + 2t$.
 (c) $2t + 2t^2$.
 (d) Taking $Y = At^2 + Bt + C$, $L[Y] = 2At^2 + 2(A+B)t + B + 2C$. Thus $A = 1/2$, $B = -1/2$ and $C = 3/4$. Therefore,

$$y = \frac{t^2}{2} - \frac{t}{2} + \frac{3}{4}.$$

- (e) y_p should be a polynomial of degree k . Note that 0 can never be a characteristic value of L because $p \neq 0$.

Section 4.3

1. (a) The characteristic value is 3, the degree is 1.
 (b) The characteristic value is 0, the degree is 3.
 (c) Not a generalized exponential.
 (d) The characteristic value is $1 \pm 3i$, the degree is 1.

Chapter 4: Nonhomogeneous Linear Equations

3. Let $Y = te^{3t}$; then $Y' = e^{3t} + 3te^{3t}$, $Y'' = 6e^{3t} + 9te^{3t}$, and

$$L[Y] = (7 + 10t)e^{3t}.$$

$L[Y]$ is a generalized exponential with characteristic value 3 and degree 1.

5. Let $Y = te^t$; then $Y' = e^t + te^t$, $Y'' = 2e^t + te^t$, and

$$L[Y] = 3e^t.$$

$L[Y]$ is a generalized exponential with characteristic value 1 and degree 0.

7. The characteristic values of L are $\lambda = \pm 1$. The characteristic value of g is -1 . Thus the appropriate choice for a trial solution is

$$Y = (At + Bt^2)e^{-t};$$

then

$$L[Y] = (-2A + 2B - 4Bt)e^{-t}.$$

Setting $L[Y] = (-6 + 4t)e^{-t}$, we obtain a particular solution $y_p = (2t - t^2)e^{-t}$.

9. The characteristic values of L are $\lambda = 1, -2$. The characteristic value of g is 3. Thus the appropriate choice for a trial solution is

$$Y = (A + Bt)e^{3t};$$

then

$$L[Y] = (10A + 7B + 10Bt)e^{3t}.$$

Setting $L[Y] = te^{3t}$, we obtain a particular solution $y_p = (-\frac{7}{100} + \frac{1}{10}t)e^{3t}$.

11. The characteristic values of L are $\lambda = 1, -2$. The characteristic value of g is 1. Thus the appropriate choice for a trial solution is

$$Y = Ate^t;$$

then

$$L[Y] = 3Ae^t.$$

Setting $L[Y] = 4e^t$, we obtain a particular solution $y_p = \frac{4}{3}te^t$.

13. The characteristic values of L are $\lambda = \pm 2i$. The characteristic value of g is $1 \pm 2i$. Thus the appropriate choice for a trial solution is

$$Y = e^t(A \cos 2t + B \sin 2t);$$

then

$$L[Y] = e^t[(A + 4B) \cos 2t + (-4A + B) \sin 2t].$$

Setting $L[Y] = e^t \cos 2t$, we obtain a particular solution $y_p = e^t(\frac{1}{17} \cos 2t + \frac{4}{17} \sin 2t)$.

15. The characteristic values of L are $\lambda = -1, -2$. The characteristic value of g is 1. Thus the appropriate choice for a trial solution is

$$Y = (A + Bt + Ct^2)e^t;$$

then

$$L[Y] = [(6A + 5B + 2C) + (6B + 10C)t + 6Ct^2]e^t.$$

Setting $L[Y] = 3t^2e^t$, we obtain a particular solution $y_p = e^t(\frac{19}{36} - \frac{5}{6}t + \frac{1}{2}t^2)$

17. The characteristic values of L are $\lambda = \pm 2$. The characteristic value for the first part of g is 2 and for the second part is 1. Thus the appropriate choice for a trial solution is

$$Y = Ate^{2t} + (B + Ct)e^t;$$

then

$$L[Y] = 4Ae^{2t} + (-3B + 2C - 3Ct)e^t.$$

Setting $L[Y] = e^{2t} + te^t$, we obtain a particular solution $y_p = \frac{1}{4}te^{2t} + (-\frac{2}{9} - \frac{1}{3}t)e^t$

19. The characteristic values of L are $\lambda = \pm 3i$. Thus the complementary solution is $y_c = c_1 \cos 3t + c_2 \sin 3t$. The characteristic value for the right hand side is 3 so the appropriate choice for a trial solution is

$$Y = Ae^{3t};$$

then

$$L[Y] = 18Ae^{3t}.$$

Setting $L[Y] = 6e^{3t}$, we obtain $A = 1/3$, so the general solution is

$$y = \frac{1}{3}e^{3t} + c_1 \cos 3t + c_2 \sin 3t.$$

Using the initial conditions, we get $y = \frac{1}{3}e^{3t} - \frac{1}{3} \cos 3t$.

21. The equation becomes $y'' - 3y' + 2y = e^{4t}$. The characteristic values of the new equation are 1 and 2. Thus, the complementary solution is $y_c = c_1e^t + c_2e^{2t}$. The characteristic value for the right hand side is 4. An appropriate choice for a trial solution is

$$Y = Ae^{4t};$$

then

$$L[Y] = 6Ae^{4t}.$$

Setting $L[Y] = e^{4t}$, we obtain $A = 1/6$, so the general solution is

$$y = \frac{1}{6}e^{4t} + c_1e^t + c_2e^{2t} = \frac{1}{6}x^4 + c_1x + c_2x^2.$$

23. The equation becomes $y'' - 3y' + 2y = te^{3t}$. The characteristic values of the new equation are 1 and 2. Thus, the complementary solution is $y_c = c_1e^t + c_2e^{2t}$. The characteristic value for the right hand side is 3. An appropriate choice for a trial solution is

$$Y = (A + Bt)e^{3t};$$

Chapter 4: Nonhomogeneous Linear Equations

then

$$L[Y] = (2A + 3B + 2Bt)e^{3t}.$$

Setting $L[Y] = te^{3t}$, we obtain $A = -\frac{3}{4}$ and $B = \frac{1}{2}$, so the general solution is

$$y = \left(-\frac{3}{4} + \frac{1}{2}t\right)e^{3t} + c_1e^t + c_2e^{2t} = \left(-\frac{3}{4} + \frac{1}{2}\ln x\right)x^3 + c_1x + c_2x^2.$$

25. (a) $Y = A + Bt + Ct^2$. $Y' = B + 2Ct$. $L[Y] = B + 2Ct + At^2 + Bt^3 + Ct^4$.
 (b) If $L[Y] = 2t + 5t^2 + t^4$ then $A = 5$, $B = 0$, and $C = 1$. Thus $Y = 5 + t^2$. There is no way to select A , B , and C so that $L[Y] = t + 5t^2 + t^4$.
 (c) The image of $L[A + Bt + Ct^2]$ has three degrees of freedom, and the set of all fourth degree polynomials has five degrees of freedom.

Section 4.4

3. The characteristic values are $\lambda = -\frac{1}{2} \pm \frac{\sqrt{35}}{2}i$. The complementary solution is

$$y_c = e^{-t/2} \left(c_1 \cos \frac{\sqrt{35}t}{2} + c_2 \sin \frac{\sqrt{35}t}{2} \right).$$

The right hand side has characteristic values $\pm 3i$, so a particular solution has the form $Y = A \cos 3t + B \sin 3t$. The method of undetermined coefficients yields $A = 0$ and $B = 1/3$. Using the initial conditions then yields the solution

$$y = \frac{1}{3} \sin t - \frac{2}{\sqrt{35}} e^{-t/2} \sin \frac{\sqrt{35}t}{2}.$$

The steady-state solution is

$$y_{ss} = \frac{1}{3} \sin t = \frac{1}{3} \cos \left(t - \frac{\pi}{2} \right).$$

See Figure 33.

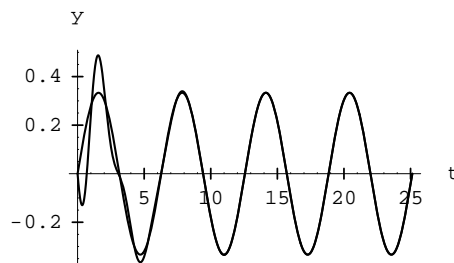

Figure 33: Exercise 4.4.3

5. The characteristic values are $\lambda = (-3 \pm \sqrt{5})/2$. The complementary solution is

$$y_c = c_1 e^{(-3+\sqrt{5})t/2} + c_2 e^{(-3-\sqrt{5})t/2}.$$

The right hand side has characteristic values $\pm 5i$, so a particular solution has the form $Y = A \cos 5t + B \sin 5t$. The method of undetermined coefficients yields $A = -5/267$ and $B = -8/267$. Using the initial conditions then yields the solution

$$y = -\frac{5}{267} \cos 5t - \frac{8}{267} \sin 5t + \frac{5 + 19\sqrt{5}}{534} e^{(-3+\sqrt{5})t/2} + \frac{5 - 19\sqrt{5}}{534} e^{(-3-\sqrt{5})t/2}.$$

The steady-state solution is

$$y_{ss} = \sqrt{\frac{89}{267}} \cos(5t - \delta), \quad \delta = \pi + \arcsin \frac{8}{\sqrt{89}}.$$

See Figure 34.

7. Let $Y = A_0 e^{3it}$ so that $Y' = 3iA_0 e^{3it}$ and $Y'' = -9A_0 e^{3it}$. Substituting this into the differential equation yields $A_0 = 1/3i$. Thus the amplitude is $|A_0| = \frac{1}{3}$, which matches the amplitude in problem 3.

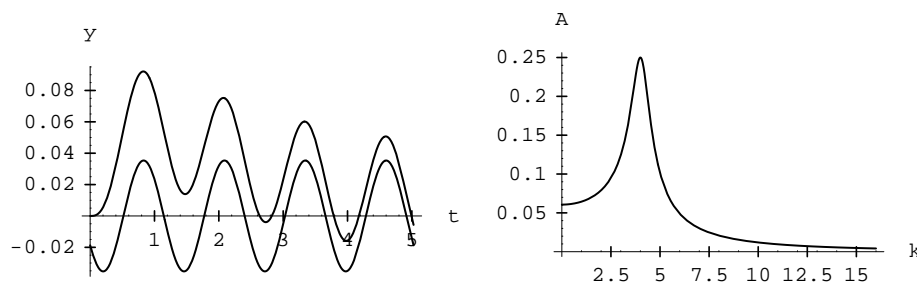

Figure 34: Exercises 4.4.5 and 4.4.9

9. (a) Taking $g = e^{4it}$ and $Y = A_0 e^{4it}$, we find $Y' = 4iA_0 e^{4it}$ and $Y'' = -16A_0 e^{4it}$. Substituting these into the differential equation yields $|A_0| = 1/\sqrt{(k^2 - 16)^2 + 16}$.
- (b) The amplitude is maximized when the denominator, $\sqrt{(k^2 - 16)^2 + 16}$, is minimized. This occurs when $(k^2 - 16)^2$ is minimized and this occurs when $k = 4$.
- (c) See Figure 34.
11. (a) The characteristic values are $\lambda = \pm 2i$, so the complementary solution is $y_c = c_1 \cos 2t + c_2 \sin 2t$. A particular solution has the form $Y = A \cos 1.4t$. The method of undetermined coefficients yields $A = 25/51$. Using the initial conditions and writing the solution in amplitude-phase shift form,

$$y(t) = \frac{25}{51} \cos 1.4t - \frac{25}{51} \cos 2t.$$

- (b) See Figure 35.

Chapter 4: Nonhomogeneous Linear Equations

(c) $\cos[2(t - 10\pi)] - \cos 1.4(t - 10\pi)] = \cos(2t - 20\pi) - \cos(1.4t - 14\pi) = \cos 2t - \cos 1.4t.$

(d) The characteristic values are $\lambda = \pm 2i$, so the complementary solution is $y_c = c_1 \cos 2t + c_2 \sin 2t$. A particular solution has the form $Y = A \cos \sqrt{2}t$. The method of undetermined coefficients yields $A = 1/2$. Using the initial conditions and writing the solution in amplitude-phase shift form,

$$y(t) = -\frac{1}{2} \cos 2t + \frac{1}{2} \cos \sqrt{2}t.$$

(e) See Figure 35.

(f) We would like to have $\cos(2(t+k)) - \cos(\beta(t+k)) = \cos 2t - \cos \beta t$ for some k . Expanding the left hand side we get

$$\cos 2k \cos 2t - \sin 2k \sin 2t - \cos \beta k \cos \beta t + \sin \beta k \sin \beta t = \cos 2t - \cos \beta t.$$

This equation reduces to

$$\cos 2k = 1, \quad \cos \beta k = 1.$$

Thus, we need the smallest k for which $2k$ and βk are integer multiples of 2π . So we may write $k = n\pi$ for some integer n and $\beta k = 2m\pi$ for some integer m ; combining these, we have $n\beta = 2m$. This implies that β is a rational number, so let it be p/q in reduced form. Then $pn = 2mq$. We seek the smallest n for which this equation is satisfied for some integer m . If p is even, we may take $m = p/2$ and obtain $n = q$; thus, the period is $q\pi$. If p is odd, we take $m = p$ and obtain $n = 2q$; thus, the period is $2q\pi$.

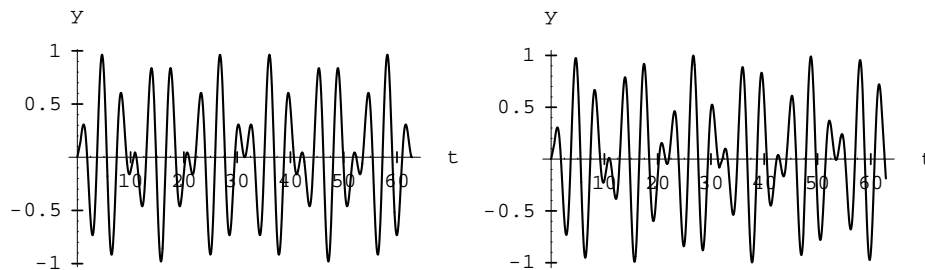

Figure 35: Exercise 4.4.11, (b) and (e)

13. (a) The outdoor temperature can be modeled by $20 - 5 \cos(\pi t/12)$. Using this in Newton's law of cooling surrounding temperature [see Section 1.1 Equation (3)], we obtain the differential equation $-\frac{dT}{dt} = k[T - (20 - 5 \cos \frac{\pi t}{12})]$, which we can rewrite as

$$\frac{dT}{dt} + kT = 20k - 5k \cos \frac{\pi t}{12}.$$

(Note that the problem could as easily be done in degrees Fahrenheit.)

- (b) The characteristic value of the complementary solution is $-k < 0$, so this solution decays to 0. The steady-state solution is the particular solution, which has the form

$$T_p = A \cos \frac{\pi t}{12} + B \sin \frac{\pi t}{12} + C.$$

Substitution into the differential equation yields the steady-state solution

$$T_p = 20 - \left[\frac{720k^2}{144k^2 + \pi^2} \cos \frac{\pi t}{12} + \frac{60k\pi}{144k^2 + \pi^2} \sin \frac{\pi t}{12} \right],$$

or

$$T_p = 20 - \frac{60k}{\sqrt{144k^2 + \pi^2}} \cos \left(\frac{\pi t}{12} - \arcsin \frac{\pi}{\sqrt{144k^2 + \pi^2}} \right).$$

(c) From $kt_h = \ln 2$ and $t_h = 3$, we have $k = \ln 2/3$ and

$$T_p = 20 - \frac{20 \ln 2}{\sqrt{16 \ln^2 2 + \pi^2}} \cos \left(\frac{\pi t}{12} - \arcsin \frac{\pi}{\sqrt{16 \ln^2 2 + \pi^2}} \right).$$

See Figure 36.

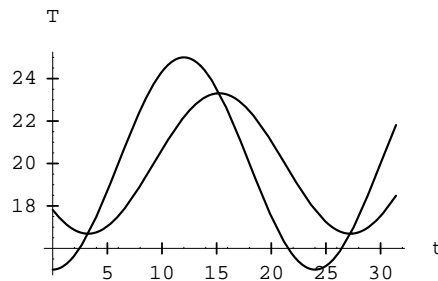

Figure 36: Exercise 4.4.13

(d) To compare with the outside temperature $S = 20 - 5 \cos(\pi t/12)$, it is most convenient to rewrite the steady-state solution in the form $T_p = 20 - A \cos(\pi[t - C]/12)$. In this form, the constant C represents the time lag of the response to the outdoor temperature variation. We have

$$A = \frac{20 \ln 2}{\sqrt{16 \ln^2 2 + \pi^2}} \approx 3.31, \quad C = \frac{12}{\pi} \arcsin \frac{\pi}{\sqrt{16 \ln^2 2 + \pi^2}} \approx 3.24,$$

and so $T_p \approx 20 - 3.31 \cos \frac{\pi(t-3.24)}{12}$. The inside temperature fluctuates between 16.7°C and 23.3°C as compared to the outside temperature fluctuation between 15°C and 25°C . The coldest inside temperature occurs 3.24 months later than the coldest outside temperature.

Section 4.5

1. The complementary solution via separation of variables is $y_c = ce^{4t}$. To solve by variation of parameters, let $y = u(t)e^{4t}$. Then $e^{4t}u' = te^t$. Thus $u(t) = \left(-\frac{t}{3} - \frac{1}{9}\right)e^{-3t}$. To solve by the method of undetermined coefficients, let $Y = (At + B)e^t$. Then $A = -\frac{1}{3}$ and $B = -\frac{1}{9}$. Either way,

$$y = \left(-\frac{t}{3} - \frac{1}{9}\right)e^t + ce^{4t}.$$

Chapter 4: Nonhomogeneous Linear Equations

3. The complementary solution via separation of variables is $y_c = ce^{4t}$. To solve by variation of parameters, let $y = u(t)e^{4t}$. Then $e^{4t}u' = te^{4t}$. Thus $u(t) = t^2/2$. To solve by the method of undetermined coefficients, let $Y = t(At + B)e^{4t}$. Then $A = \frac{1}{2}$ and $B = 0$. Either way,

$$y = \frac{t^2}{2}e^{4t} + ce^{4t}.$$

5. The complementary solution via separation of variables is $y_c = ce^{3t}$. To solve by variation of parameters, let $y = u(t)e^{3t}$. Then $e^{3t}u' = \cos t$. Thus $u(t) = e^{-3t} \left(\frac{1}{10} \sin t - \frac{3}{10} \cos t \right)$. To solve by the method of undetermined coefficients, let $Y = A \cos t + B \sin t$. Then $A = -\frac{3}{10}$ and $B = \frac{1}{10}$. Either way,

$$y = \frac{1}{10} \sin t - \frac{3}{10} \cos t + ce^{3t}.$$

7. The complementary solution via separation of variables is $y_c = ce^{-t}$. To solve by variation of parameters, let $y = u(t)e^{-t}$. Then $e^{-t}u' = 1/(1 + e^t)$. Thus $u = \ln(e^t + 1)$. Hence,

$$y = \ln(e^t + 1)e^{-t} + ce^{-t}.$$

9. The complementary solution via separation of variables is $y_c = ce^{-t^2/2}$. To solve by variation of parameters, let $y = u(t)e^{-t^2/2}$. Then $e^{-t^2/2}u' = 2t$. Thus $u = 2e^{t^2/2}$. Hence,

$$y = 2 + ce^{-t}.$$

11. The complementary solution via separation of variables is $y_c = ce^{-t^2}$. To solve by variation of parameters, let $y = u(t)e^{-t^2}$. Then $e^{-t^2}u' = e^{-t^2} \cos t$. Thus $u = \sin t$. Hence,

$$y = e^{-t^2} \sin t + ce^{-t^2}.$$

13. The complementary solution via separation of variables is $y_c = ct^{-1}e^{-t}$. To solve by variation of parameters, let $y = t^{-1}e^{-t}u(t)$. Then $t^{-1}e^{-t}u' = t^{-1}$. Thus $u = e^t$. Hence,

$$y = \frac{1 + ce^{-t}}{t}.$$

15. The complementary solution via separation of variables is $y_c = \sec t$. To solve by variation of parameters, let $y = u(t) \sec t$. Then $(\sec t)u' = 1$. Thus $u = \sin t$. Hence,

$$y = \tan t + c \sec t.$$

17. The complementary solution via separation of variables is $y_c = t^2$. To solve by variation of parameters, let $y = u(t)t^2$. Then $t^2u' = 6t^4$. Thus $u = 2t^3$ and $y = 2t^5 + ct^2$. Using the initial condition, we get

$$y = 2t^5 - 2t^2, \quad -\infty < t < \infty.$$

19. The complementary solution via separation of variables is $y_c = 1 + t^2$. To solve by variation of parameters, let $y = u(t)(1 + t^2)$. Then $(1 + t^2)u' = 1$. Thus $u = \arctan t$ and $y = (1 + t^2)(\arctan t + c)$. Using the initial condition, we get

$$y = (1 + t^2) \arctan t, \quad -\infty < t < \infty.$$

- 21.** The complementary solution via separation of variables is $y_c = \cos^2 t$. To solve by variation of parameters, let $y = u(t) \cos^2 t$. Then $(\cos^2 t)u' = 1$. Thus $u = \tan t$ and $y = \sin t \cos t + c \cos^2 t$. Using the initial condition, we get

$$y = \cos t(\cos t + \sin t), \quad -\pi/2 < t < \pi/2.$$

- 23.** The complementary solution via separation of variables is $y_c = e^{4t^2}$. To solve by variation of parameters, let $y = u(t)e^{4t^2}$. Then $e^{4t^2}u' = 1$. Thus

$$u = \int_0^t e^{-4s^2} ds = \frac{1}{2} \int_0^{2t} e^{-r^2} dr = \frac{\sqrt{\pi}}{4} \operatorname{erf} 2t, \quad y = \frac{\sqrt{\pi}}{4} e^{4t^2} \operatorname{erf} 2t + ce^{4t^2}.$$

Using the initial condition, we get

$$y = \frac{\sqrt{\pi}}{4} e^{4t^2} \operatorname{erf} 2t + e^{4t^2}, \quad -\infty < t < \infty.$$

- 25.** Rewrite the equation as $t^2 y^{-3} y' + 2ty^{-2} = 1$. Let $w = y^{-2}$. In terms of w , the equation becomes $t^2 w' - 4tw = -2$. The complementary solution via separation of variables is ct^4 . Now the substitution $w = u(t)t^4$ yields the equation $t^4 u' = -2t^{-2}$. We obtain $u = 2/(5t^5)$ and $w = 2/(5t) + ct^4$. Therefore

$$y = \left(\frac{2}{5t} + \frac{c}{t^4} \right)^{-1/2}.$$

- 27.** Rewrite the equation as $p^{-2} p' - rp^{-1} = -r/K$. Let $w = p^{-1}$. In terms of w , the equation becomes $w' + rw = -r/K$. This is the same as Newton's law of cooling; by various methods, the solution is $w = 1/K + ce^{-rt}$. Thus,

$$p = \frac{K}{1 + cKe^{-rt}}.$$

- 29.** (a) If $n = -m$, we have $ty' + my = kt^{-m}$. The complementary solution via separation of variables is ct^{-m} . The substitution $y = u(t)t^{-m}$ yields the equation $t^{-m}u' = kt^{-m-1}$, from which we obtain $u = k \ln t$ and

$$y = (k \ln t + c)t^{-m}.$$

- (b) If $n \neq -m$, the procedure from part (a) yields $u' = kt^{m+n-1}$. Hence, $u = \frac{k}{m+n} t^{m+n}$ and

$$y = \frac{k}{m+n} t^n + ct^{-m}.$$

- (c) With some initial conditions, such as $y(0) = 0$, the solution is $y = kt^n/(m+n)$, which is valid for all t . This does not contradict the existence and uniqueness theorem. It is always possible to get a better result than what is guaranteed by the theorem.
- (d) No. Regardless of the value of c , the particular solution is undefined at $t = 0$ when $n < 0$.

Chapter 4: Nonhomogeneous Linear Equations

31. (a) Solving the associated homogeneous problem by separation of variables, $y_c = \cos t$. To solve for a particular solution using variation of parameters, let $y = u(t) \cos t$. Then $(\cos t)u' = \sin t$, so $u = -\ln|\cos t|$ and the general solution is $y = \cos t(c - \ln|\cos t|)$. The solution of the initial value problem is then

$$y = [k - \ln(\cos t)] \cos t, \quad -\frac{\pi}{2} < t < \frac{\pi}{2}.$$

- (b) With L'Hôpital's rule, we have

$$\lim_{t \rightarrow \pm\pi/2} y = \lim_{t \rightarrow \pm\pi/2} \frac{k - \ln(\cos t)}{\sec t} = \lim_{t \rightarrow \pm\pi/2} \frac{\tan t}{\sec t \tan t} = \lim_{t \rightarrow \pm\pi/2} \cos t = 0.$$

- (c) For the solution to vanish in the interior of its interval of validity, we must have $\ln(\cos t) = k$ for some $t \in (-\pi/2, \pi/2)$. Over this interval in t , the cosine function has the range $(0, 1]$, so any negative value of k satisfies the requirement.
- (d) Rewriting the differential equation, we have $y' = (\tan t)(\cos t - y)$; hence, the solution has critical points wherever $\tan t = 0$ or $y(t) = \cos t$. Given the solution of part (a) and the interval of validity, we have a critical point at $t = 0$ and a critical point wherever $\ln(\cos t) = k - 1$. The latter equation has a solution if and only if $k < 1$, by the argument of part (c). For the origin to be the global minimum, it must certainly be a local minimum as well. Differentiating the original differential equation yields $y'' + y' \tan t + y \sec^2 t = \cos t$, which we can evaluate at $t = 0$ to obtain $y''(0) = 1 - k$. Thus, the origin is a local maximum if $k > 1$ and not if $k < 1$. Since $y(0) = k > 0$ for the $k > 1$ case and $y \rightarrow 0$ approaching the endpoints of the interval, it follows that the origin is the global maximum whenever $k > 1$. It remains only to consider the case $k = 1$. One way to check this case is to expand $y = [1 - \ln(\cos t)] \cos t$ as a power series about $t = 0$. Combining the series $\ln(1 + x) = x - \frac{1}{2}x^2 + \frac{1}{3}x^3 + \dots$ and $\cos t = 1 - \frac{1}{2}t^2 + \frac{1}{24}t^4 + \dots$, we obtain

$$\begin{aligned} \ln(\cos t) &= \ln\left(1 - \frac{1}{2}t^2 + \frac{1}{24}t^4 + \dots\right) \\ &= \left(-\frac{1}{2}t^2 + \frac{1}{24}t^4 + \dots\right) - \frac{1}{2}\left(-\frac{1}{2}t^2 + \frac{1}{24}t^4 + \dots\right)^2 + \dots \\ &= \left(-\frac{1}{2}t^2 + \frac{1}{24}t^4 + \dots\right) - \frac{1}{2}\left(\frac{1}{4}t^4 + \dots\right) \\ &= -\frac{1}{2}t^2 - \frac{1}{12}t^4 + \dots \end{aligned}$$

Thus,

$$y = [1 - \ln(\cos t)] \cos t = \left(1 + \frac{1}{2}t^2 + \frac{1}{12}t^4 + \dots\right) \left(1 - \frac{1}{2}t^2 + \frac{1}{24}t^4 + \dots\right) = 1 - \frac{1}{8}t^4 + \dots$$

This approximation is valid in the limit as $t \rightarrow 0$, so we may conclude that the origin is a local maximum of y as well as being a local maximum of $1 - \frac{1}{8}t^4$.

33. First solve the problem on the interval $0 < t \leq T$. The complementary solution is $y_c = e^{-t}$. A particular solution is $y_p = 1$. Thus $y = 1 - e^{-t}$. Now we want to solve the initial value problem $y' + y = 0$ with $y(T) = 1 + e^{-T}$. The solution of this is $y = ce^{-t}$ where $c = e^T - 1$. Thus we have

$$y = \begin{cases} 1 - e^{-t}, & 0 < t \leq T \\ (e^T - 1)e^{-t}, & T < t \end{cases}$$

35. (a) The conditions in the problem are modeled by the an equation of the form

$$\frac{dP}{dt} = (a - c \cos(bt))P - R,$$

for some choice of a , b , and c . The condition on the period implies $b = \pi/6$. The condition on the half-life at the minimum means that $c - a = \ln 2/6$. The condition on the growth rate at the maximum means that $c + a = \ln 2/3$. Solving for a and c yields the desired equation.

- (b) By separation of variables, we obtain

$$P_1 = \exp \left[\frac{\ln 2}{12} \left(t - \frac{18}{\pi} \sin \frac{\pi t}{6} \right) \right].$$

- (c) Using variation of parameters, let $P_p = u(t)P_1$. Then $P_1 u' = -R$. Thus, $u = -R \int_0^t P_1^{-1}(s) ds$. Therefore,

$$P_p = -R \exp \left[\frac{\ln 2}{12} \left(t - \frac{18}{\pi} \sin \frac{\pi t}{6} \right) \right] \int_0^t \exp \left[-\frac{\ln 2}{12} \left(\tau - \frac{18}{\pi} \sin \frac{\pi \tau}{6} \right) \right] d\tau.$$

- (d) Since $P(0) = 1$ and $P(0) = P_1(0)[u(0) + c] = c$, we have $c = 1$. Thus, $P = P_1(t)[1 - R \int_0^t P_1^{-1}(s) ds]$, or

$$P = \left\{ 1 - R \int_0^t \exp \left[-\frac{\ln 2}{12} \left(\tau - \frac{18}{\pi} \sin \frac{\pi \tau}{6} \right) \right] d\tau \right\} \exp \left[\frac{\ln 2}{12} \left(t - \frac{18}{\pi} \sin \frac{\pi t}{6} \right) \right].$$

- (e) Observe that $P_1(12) = 2$. If $P(12) = 1$, then $1 = 2[1 - R \int_0^{12} P_1^{-1}(s) ds]$, or $R \int_0^{12} P_1^{-1}(s) ds = \frac{1}{2}$. Computing the integral numerically yields $R \approx 0.0543$.
- (f) The minimum population occurs at 3 months and the maximum population occurs at 9 months. These peaks lag behind the growth rate peaks because there is a period of low but increasing growth after $t = 0$ and a period of high but decreasing growth after $t = 6$. See Figure 37.

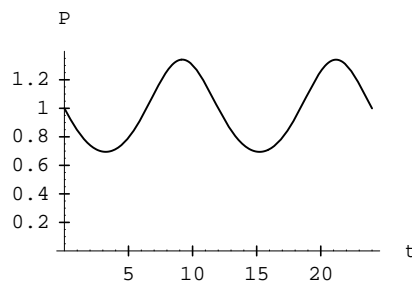

Figure 37: Exercise 4.5.35

Section 4.6

1. The complementary solution via undetermined coefficients is $y_c = c_1 e^t + c_2 e^{-t}$. The system of equations produced by variation of parameters is

$$\begin{aligned} e^t u_1' + e^{-t} u_2' &= 0 \\ e^t u_1' - e^{-t} u_2' &= (-6 + 4t)e^{-t} \end{aligned}$$

Chapter 4: Nonhomogeneous Linear Equations

The solution to this system is $u'_1 = (-3 + 2t)e^{-2t}$, $u'_2 = 3 - 2t$, so $u_1 = (1 - t)e^{-2t}$ and $u_2 = 3t - t^2$. A particular solution is

$$y = u_1 e^t + u_2 e^{-t} = e^{-t}(-t^2 + 2t + 1).$$

This differs from that of Section 4.3, but both are correct.

3. The complementary solution via undetermined coefficients is $y_c = c_1 e^t + c_2 e^{-2t}$. The system of equations produced by variation of parameters is

$$\begin{aligned} e^t u'_1 + e^{-2t} u'_2 &= 0 \\ e^t u'_1 - 2e^{-2t} u'_2 &= te^{3t} \end{aligned} \cdot$$

The solution to this system is $u'_1 = \frac{1}{3}te^{2t}$, $u'_2 = -\frac{1}{3}te^{5t}$, so $u_1 = (\frac{1}{6}t - \frac{1}{12})e^{2t}$ and $u_2 = (\frac{1}{75} - \frac{1}{15}t)e^{5t}$. A particular solution is

$$y = u_1 e^t + u_2 e^{-2t} = e^{3t} \left(\frac{t}{10} - \frac{7}{100} \right).$$

5. The complementary solution via undetermined coefficients is $y_c = c_1 \cos 2t + c_2 \sin 2t$. The system of equations produced by variation of parameters is

$$\begin{aligned} (\cos 2t)u'_1 + (\sin 2t)u'_2 &= 0 \\ -2(\sin 2t)u'_1 + 2(\cos 2t)u'_2 &= \sec 2t \end{aligned} \cdot$$

The solution to this system is $u'_1 = -\frac{1}{2} \tan 2t$, $u'_2 = \frac{1}{2}$, so $u_1 = \frac{1}{4} \ln(\cos 2t)$ and $u_2 = \frac{1}{2}t$. The general solution is

$$y = \frac{1}{4} \ln(\cos 2t) \cos 2t + \frac{t}{2} \sin 2t + c_1 \cos 2t + c_2 \sin 2t.$$

7. The complementary solution via undetermined coefficients is $y_c = c_1 e^{-t} + c_2 t e^{-t}$. The system of equations produced by variation of parameters is

$$\begin{aligned} e^{-t} u'_1 + t e^{-t} u'_2 &= 0 \\ -e^{-t} u'_1 + (1 - t) e^{-t} u'_2 &= t^{-p} e^{-t} \end{aligned} \cdot$$

The solution to this system is $u'_1 = -t^{1-p}$, $u'_2 = t^{-p}$. thus, $u_1 = -\frac{1}{2-p} t^{2-p}$ for $p \neq 2$ and $u_1 = -\ln t$ for $p = 2$, while $u_2 = \frac{1}{1-p} t^{1-p}$ for $p \neq 1$ and $u_2 = \ln t$ for $p = 1$. We therefore require separate solution formulas for the cases $p = 1$ and $p = 2$. The general solution is

$$y = \begin{cases} (t \ln t + c_1 + c_2 t) e^{-t} & p = 1 \\ (-\ln t + c_1 + c_2 t) e^{-t} & p = 2 \\ \left(\frac{1}{(2-p)(1-p)} t^{2-p} + c_1 + c_2 t \right) e^{-t} & p > 2 \end{cases} \cdot$$

9. $y_1 = x$, $y'_1 = 1$, $y''_1 = 0$, and $y_2 = e^x$, $y'_2 = e^x$, $y''_2 = e^x$ so they are both solutions of the associated homogeneous problem. Using variation of parameters to find a particular solution leads us to the system

$$\begin{aligned} x u'_1 + e^x u'_2 &= 0 \\ u'_1 + e^x u'_2 &= \frac{x e^{-x}}{1-x} \end{aligned} \cdot$$

The solution to this system is

$$u_1' = \frac{xe^{-x}}{(1-x)^2}, \quad u_2' = -\frac{x^2e^{-2x}}{(1-x)^2}.$$

Neither of these can be integrated in terms of elementary functions, so we construct the antiderivatives and obtain the general solution

$$y = x \left(c_1 + \int_0^x \frac{se^{-s}}{(1-s)^2} ds \right) + e^x \left(c_2 - \int_0^x \frac{s^2e^{-2s}}{(1-s)^2} ds \right).$$

11. $y_1 = x^{-1/2} \cos x$, $y_1' = -\frac{1}{2}x^{-3/2} \cos x - x^{-1/2} \sin x$, $y_1'' = \frac{3}{4}x^{-5/2} \cos x + x^{-3/2} \sin x - x^{-1/2} \cos x$ and $y_2 = x^{-1/2} \sin x$, $y_2' = -\frac{1}{2}x^{-3/2} \sin x + x^{-1/2} \cos x$, $y_2'' = \frac{3}{4}x^{-5/2} \sin x - x^{-3/2} \cos x - x^{-1/2} \sin x$, so both are solutions of the associated homogeneous problem. Using variation of parameters to find a particular solution leads us to the system

$$\begin{aligned} x^{-1/2}(\cos x)u_1' + x^{-1/2}(\sin x)u_2' &= 0 \\ (-\frac{1}{2}x^{-3/2} \cos x - x^{-1/2} \sin x)u_1' + (-\frac{1}{2}x^{-3/2} \sin x + x^{-1/2} \cos x)u_2' &= x^{3/2} \cos x \end{aligned}.$$

The solution to this system is $u_1' = -\frac{1}{4} \sin x \cos x$, $u_2' = \frac{1}{4} \cos^2 x = \frac{1}{8} + \frac{1}{8} \cos 2x$, so $u_1 = -\frac{1}{8} \sin^2 x$ and $u_2 = \frac{1}{8}x + \frac{1}{16} \sin 2x = \frac{1}{8}x + \frac{1}{8} \sin x \cos x$. The general solution is

$$y = \frac{1}{8}x^{1/2} \sin x + c_1x^{-1/2} \cos x + c_2x^{-1/2} \sin x.$$

13. (a) $y_1 = 1 + x$, $y_1' = 1$, $y_1'' = 0$ and $y_2 = e^x$, $y_2' = e^x$, and $y_2'' = e^x$, so both are solutions of the associated homogeneous problem.
 (b) In general, variation of parameters leads us to the system

$$\begin{aligned} (1+x)u_1' + e^xu_2' &= 0 \\ u_1' + e^xu_2' &= x^{-1}g(x) \end{aligned}.$$

The Wronskian is $W[1+x, e^x] = xe^x$, so we have

$$u_1' = -x^{-2}g(x), \quad u_2' = (x^{-2} + x^{-1})e^{-x}g(x)$$

for any $g(x)$. For the case $g \equiv 1$, we obtain $u_1 = x^{-1}$ and, integrating either term by parts once, $u_2 = \int x^{-2}e^{-x} dx + \int x^{-1}e^{-x} dx = -x^{-1}e^{-x}$. We therefore obtain the result $y_p = 1$, which we can quickly verify by inspection. For the case $g(x) = x^2$, we obtain $u_1 = -x$ and $u_2 = (-2-x)e^{-x}$, with the result $y_p = -2 - 2x - x^2$. We can use this particular solution, but there is actually an easier one. We have $y_p = -2y_1 - x^2$ and $L[y_p] = x^2$, from which it follows that $L[-x^2] = x^2$. Now, by linearity, we know that

$$L[a + b(-x^2)] = aL[1] + bL[-x^2] = a + bx^2;$$

hence, a particular solution of $L[y] = a + bx^2$ is $y_p = a - bx^2$.

- (c) Using the general formulas for u_1' and u_2' from part (b), we have $u_1' = -x^{p-2}$ and $u_2' = (x^{p-2} + x^{p-1})e^{-x}$. Now we note the reduction formula

$$\int x^m e^{-x} dx = -x^m e^{-x} + m \int x^{m-1} e^{-x} dx.$$

Chapter 4: Nonhomogeneous Linear Equations

Applying this to the second term of u'_2 yields $u_2 = -x^{p-1}e^{-x} + p \int x^{p-2}e^{-x} dx$. We therefore have the particular solution

$$y_p = u_1y_1 + u_2y_2 = -\frac{1}{p-1}x^p - \frac{p}{p-1}x^{p-1} + pe^x \int x^{p-2}e^{-x} dx.$$

The reduction formula shows that the remaining integral yields the term $-px^{p-2}$, followed by additional terms that clearly all are power functions with powers from $p-3$ down to 0. Hence, the particular solution is a polynomial. There is an easier way to show that the particular solutions are all polynomials, and that is by looking for such a solution. A bit of calculation shows that

$$L[c_px^p + c_{p-1}x^{p-1} + c_{p-2}x^{p-2} + \cdots + c_1x + c_0] = (1-p)c_px^p + (2-p)(c_{p-1} - pc_p)x^{p-1} + (3-p)[c_{p-2} - (p-1)c_{p-1}]x^{p-2} - \cdots - (c_2 - 3c_3)x^2 + (c_0 - c_1).$$

Setting this result equal to x^p results in a set of p equations for the $p+1$ unknowns c_0 to c_p . However, observe that choosing $c_1 = c_0 = 0$ reduces the number of unknowns to $p-1$ and reduces the number of equations to $p-1$ as well. The equations are decoupled, so there is clearly a unique solution.

- (d) Note that $E'_1(x) = -x^{-1}e^{-x}$ by the fundamental theorem of calculus. Using the general formulas for u'_1 and u'_2 from part (b), we have $u'_1 = -x^{-1}$ and $u'_2 = (x^{-1} + 1)e^{-x}$. Thus, $u_1 = -\ln x$ and $u_2 = -e^{-x} - E_1(x)$. We therefore have the particular solution

$$y_p = -1 - (1+x)\ln x - e^x E_1(x).$$

15. (a) The characteristic values are $\lambda = \pm i$, so the complementary solution is $y_c = c_1 \cos t + c_2 \sin t$. The systems of equations produced by variation of parameters is

$$\begin{aligned} u'_1 \cos t + u'_2 \sin t &= 0 \\ -u'_1 \sin t + u'_2 \cos t &= g(t) \end{aligned}.$$

The solution to this system is

$$\begin{aligned} u_1 &= -\int_0^t g(s) \sin s ds \\ u_2 &= \int_0^t g(s) \cos s ds. \end{aligned}.$$

The particular solution is

$$y = \sin t \int_0^t g(s) \cos s ds - \cos t \int_0^t g(s) \sin s ds.$$

- (b) Substituting $g(t) = \sin t$ into the above integrals yields

$$\int_0^t \sin s \cos s ds = \frac{1}{2} \sin^2 t$$

and

$$\int_0^t \sin^2 s ds = \int_0^t \frac{1}{2} - \frac{1}{2} \cos 2s ds = \frac{1}{2}t + \frac{1}{4} \sin 2t = \frac{1}{2}t - \frac{1}{2} \sin t \cos t.$$

Thus a particular solution in this case is

$$y = \frac{1}{2} \sin^3 t - \frac{1}{2}t \cos t + \frac{1}{2} \sin t \cos^2 t = \frac{1}{2} \sin t - \frac{1}{2}t \cos t.$$

- (c) The solution is given by the same integrals used in part (b), except that the function g is 0 after time T . The upper limit of integration is therefore the smaller of t and T . It follows that for $t > T$, the solution is

$$y = \frac{1}{2} \sin^2 T \sin t + \frac{1}{2} (\sin T \cos T - T) \cos t.$$

- (d) The amplitude of the steady state solution is

$$A = \frac{1}{2} \sqrt{\sin^4 T + \sin^2 T \cos^2 T - 2T \sin T \cos T + T^2} = \frac{1}{2} \sqrt{\sin^2 T - 2T \sin T \cos T + T^2}.$$

See Figure 38.

- (e) See Figure 38.

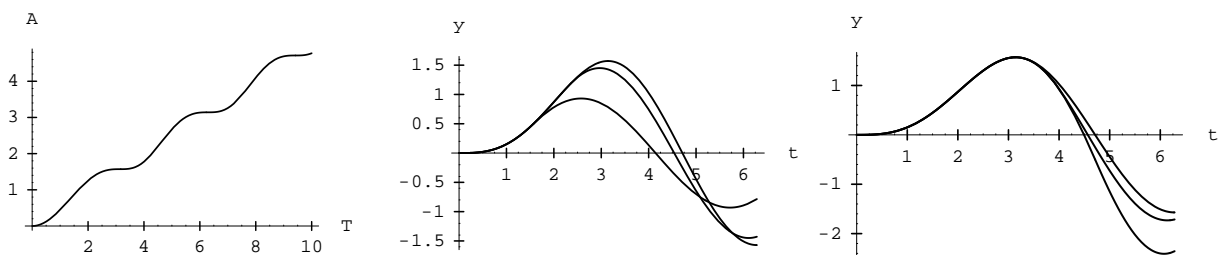

Figure 38: Exercise 4.6.15

17. (a) $y_p = u_1 y_1 + u_2 y_2 + u_3 y_3$

(b)

$$\begin{pmatrix} y_1 & y_2 & y_3 \\ y_1' & y_2' & y_3' \\ y_1'' & y_2'' & y_3'' \end{pmatrix} \begin{pmatrix} u_1' \\ u_2' \\ u_3' \end{pmatrix} = \begin{pmatrix} 0 \\ 0 \\ g \end{pmatrix}.$$

(c)

$$u_1' = \frac{(y_2 y_3' - y_2' y_3 g)}{W[y_1, y_2, y_3]}, \quad u_2' = \frac{-(y_1 y_3' - y_1' y_3 g)}{W[y_1, y_2, y_3]}, \quad u_3' = \frac{(y_1 y_2' - y_1' y_2) g}{W[y_1, y_2, y_3]}.$$

19. The characteristic values of L are $-1, 1, 2$, so the complementary solution is $y_c = c_1 e^t + c_2 e^{2t} + c_3 e^{-t}$. The Wronskian is $W[y_1, y_2, y_3] = 6e^{2t}$. From Exercise 17, $u_1' = -\frac{1}{2}$, $u_2' = \frac{1}{3}e^{-t}$, and $u_3' = \frac{1}{6}e^{2t}$, so $u_1 = -\frac{1}{2}t$, $u_2 = -\frac{1}{3}e^{-t}$, and $u_3 = \frac{1}{12}e^{2t}$. A particular solution is then

$$y_p = u_1 e^t + u_2 e^{2t} + u_3 e^{-t} = \left(-\frac{1}{4} - \frac{1}{2}t \right) e^t.$$

One could also get $y_p = \left(\frac{1}{4} - \frac{1}{2}t \right) e^t$ by numbering the terms of the complementary solution in a different order.

21. (a) The characteristic values of L are $\lambda = 0, 0, -1, 1$. Writing the homogeneous solution using hyperbolic functions, $y_c = c_1 + c_2 x + c_3 \sinh x + c_4 \cosh x$.
- (b) If $y_p = -\int_0^x s w(s) ds + x \int_0^x w(s) ds + \int_0^x \sinh(s-x) w(s) ds$ then $y_p' = \int_0^x w(s) ds + \int_0^x -\cosh(s-x) w(s) ds$ and $y_p'' = +\int_0^x \sinh(s-x) w(s) ds$ and $y_p''' = \int_0^x -\cosh(s-x) w(s) ds$ and $y_p'''' = -w(x) + \int_0^x \sinh(s-x) w(s) ds$.

Chapter 4: Nonhomogeneous Linear Equations

- (c) The condition $y(0) = 0$ implies that $c_4 = -c_1$. The condition $y'(0) = 0$ implies that $c_3 = -c_2$. Thus, we have the 2-parameter family

$$y = -\int_0^x s w(s) ds + x \int_0^x w(s) ds + \int_0^x \sinh(s-x) w(s) ds + c_1(1 - \cosh x) + c_2(x - \sinh x).$$

- (d) Substituting

$$w(x) = \begin{cases} 0, & \text{if } x < 0.9 \\ 10, & \text{if } 0.9 \leq x < 1 \end{cases}$$

into the expression for y_p yields 0 for $x < 0.9$ and $y_p = 10 \int_{0.9}^x [x - s + \sinh(s - x)] ds$. Thus,

$$y_p(x) = \begin{cases} 0, & x < 0.9 \\ 5(x - 0.9)^2 + 10 - 10 \cosh(x - 0.9), & 0.9 \leq x < 1 \end{cases}.$$

- (e) The boundary conditions at $x = 1$ reduce to the equations

$$(\cosh 1)c_1 + (\sinh 1)c_2 = 10 - 10 \cosh 0.1, \quad (\sinh 1)c_1 + (\cosh 1)c_2 = -10 \sinh 0.1,$$

from which we obtain $c_1 = 10 \cosh 1 - 10 \cosh 1 \cosh 0.1 + 10 \sinh 1 \sinh 0.1 = 10(\cosh 1 - \cosh 0.9)$ and $c_2 = -10 \sinh 1 + 10 \sinh 1 \cosh 0.1 - 10 \cosh 1 \sinh 0.1 = 10(\sinh 0.9 - \sinh 1)$.

- (f) The solution is given approximately by

$$y = 1.100(1 - \cosh x) - 1.487(x - \sinh x) + y_p,$$

where y_p is given in part (d).

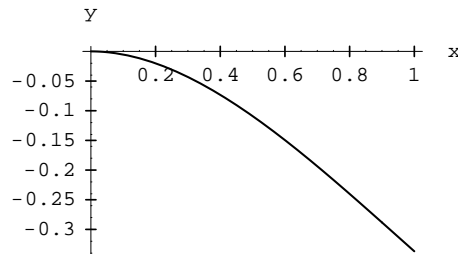

Figure 39: Exercise 4.6.21

Section 5.1

1. The population will increase if $p' > 0$. This will occur when $1 - p/10 > 0$, or $p < 10$. Similarly, the population will decrease when $p > 10$.
3. (a) This is not a predator-prey model because x and y increase in the presence of each other. This would model a cooperative or symbiotic relationship.
 (b) This is a predator-prey model. x decreases in the presence of y and y increases in the presence of x . Thus x is the prey and y is the predator.
 (c) This is not a predator-prey model because x and y decrease in the presence of each other. This would model a competitive relationship.
5. (a) x decreases in the presence of y and y increases in the presence of x so they are not competing. This is a predator-prey model.
 (b) x decreases in the presence of y and y decreases in the presence of x so they are competing. However, this is not a realistic model because y is not self-limiting. It doesn't make any sense for the growth rate of y to be arbitrarily large in the absence of x .
 (c) x decreases in the presence of y and y decreases in the presence of x so they are competing.

7.

$$X = \frac{b}{a}x, \quad Y = \frac{s}{t}y, \quad \text{and} \quad \tau = rt.$$

First replacing the dependent variables,

$$\frac{dX}{dt} = \frac{dX}{dx} \frac{dx}{dt} = r(X - YX), \quad \frac{dY}{dt} = \frac{dY}{dy} \frac{dy}{dt} = a(Y - XY).$$

Replacing the independent variable,

$$\frac{dX}{d\tau} = \frac{dX}{dt} \frac{dt}{d\tau} = X(1 - Y), \quad \frac{dY}{d\tau} = \frac{dY}{dt} \frac{dt}{d\tau} = kY(1 - X),$$

where $k = a/r$.

9.

$$\frac{dx}{dt} = rx \left(1 - \frac{x}{k}\right) - sxy \quad \text{and} \quad \frac{dy}{dt} = csxy - my.$$

11. (a) The recovery of infectives increases the susceptible population, so we have

$$\frac{dS}{dt} = -rSI + \gamma I, \quad \frac{dI}{dt} = -\gamma I + rSI.$$

- (b) The infection process requires both an infected person and a susceptible person. In both cases, it makes sense that doubling the number should double the rate of the process. Thus, the rate should be proportional to each population. Similarly, the rate of recovery should be expected to double if the number of sick people is doubled.

13. (a)

$$\frac{dw}{dt} = -kwx \quad \text{and} \quad \frac{dx}{dt} = ckwx - mx.$$

(b) First replacing the dependent variables,

$$\frac{dW}{dt} = \frac{dW}{dw} \frac{dw}{dt} = -kx_r X, \quad \frac{dX}{dt} = \frac{dX}{dx} \frac{dx}{dt} = kcw_r W X - mX.$$

Replacing the independent variable by $\tau = t/t_r$ yields

$$\frac{dW}{d\tau} = \frac{dW}{dt} \frac{dt}{d\tau} = -kx_r t_r X, \quad \frac{dX}{d\tau} = \frac{dX}{dt} \frac{dt}{d\tau} = kcw_r t_r W X - m t_r X.$$

(c) All dimensionless parameters disappear if $t_r = 1/m$, $w_r = m/ck$, and $x_r = m/k$.

The system of this exercise is known as the *chemostat*.

Section 5.2

1. See Figure 40.

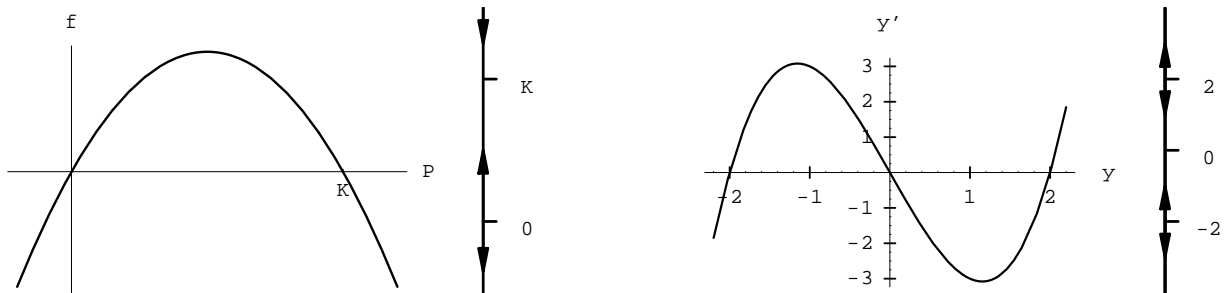

Figure 40: Exercises 5.2.1 and 5.2.3

3. (a) The equilibrium solutions are $y = 0, \pm 2$.
- (b) See Figure 40.
- (c) See Figure 40.
- (d) The solution $y = 0$ is stable and the solutions $y = \pm 2$ are both unstable.

5. (a) The equilibrium solution is $y = 0$.
- (b) See Figure 41.
- (c) See Figure 41.
- (d) The solution $y = 0$ is unstable.

7. (a) The equilibrium solution is $y = 0$.
- (b) See Figure 41.
- (c) See Figure 41.
- (d) The solution $y = 0$ is stable.

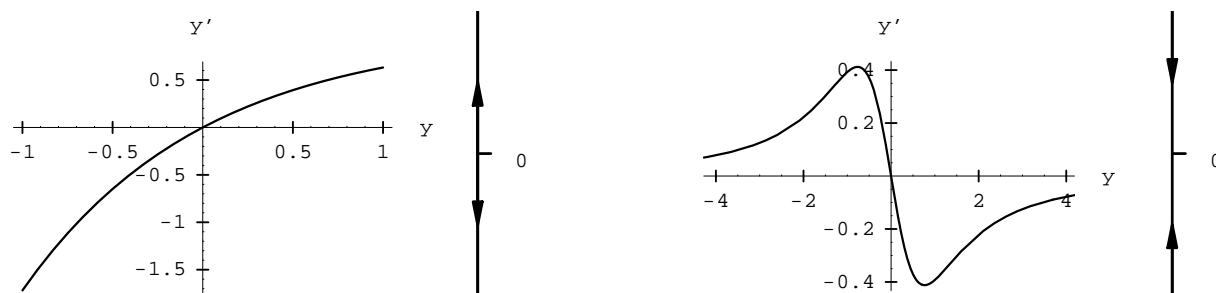

Figure 41: Exercises 5.2.5 and 5.2.7

9. Exercise 4. The critical value is the unstable critical point $y = 1$.
13. The equilibrium solution is $x = A$. The full solution can be found by separation of variables to be

$$x = A - Ae^{-Bt}.$$

From $A/2 = A - Ae^{-Bt}$, we have $t = (\ln 2)/B$.

15. (a) First replacing the dependent variables,

$$\frac{dy}{dt} = \frac{dy}{dp} \frac{dp}{dt} = ry(1 - y) - Ey.$$

Replacing the independent variable then yields

$$\frac{dy}{d\tau} = \frac{dy}{dt} \frac{dt}{d\tau} = y(1 - y) - hy.$$

- (b) If $E > r$, then $h > 1$ and $\frac{dy}{dt} = -y^2 - (h - 1)y$ is always negative so the population will decrease.
- (c) From $y' = y(1 - y - h)$ with $h < 1$, we have the equilibrium solution $y_e = 1 - h > 0$. The phase line must be in the form shown in Figure 42; hence, y_e is stable.
- (d) Since h can have any value between 0 and 1, y_e can have any value between 0 and 1. See Figure 42.
- (e) We have $Y(h) = hy_e = h(1 - h)$. See Figure 42.
- (f) The maximum occurs when $h = 1/2$, as this is the vertex of the parabola.

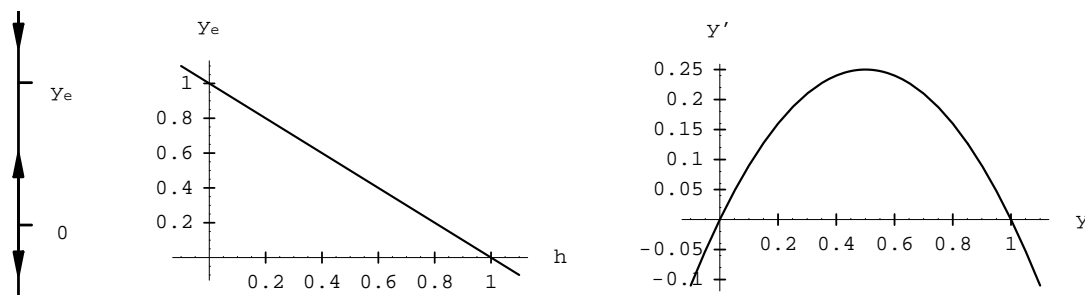

Figure 42: Exercise 5.2.15, parts (c), (d), (e)

Section 5.3

1. The trajectories are found by solving

$$-x = \frac{dy}{dx}(-xy).$$

The solution, via separation of variables, is $x = y^2/2 + c$. A sample of the trajectories can be found in Figure 43.

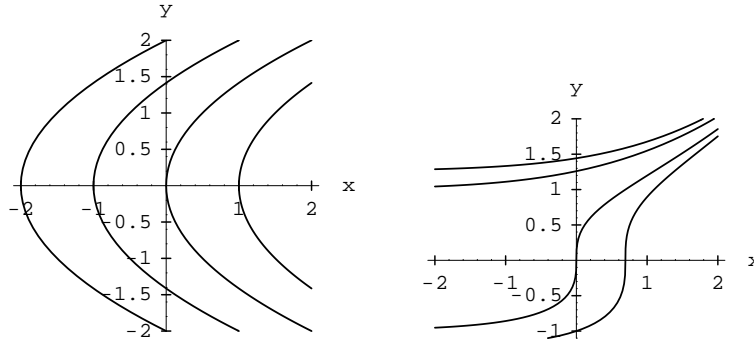

Figure 43: Exercises 5.3.1 and 5.3.3

3. The trajectories are found by solving

$$e^x = \frac{dy}{dx} 3y^2.$$

The solution, via separation of variables, is $e^x = y^3 + c$. A sample of the trajectories can be found in Figure 43.

5. Let $v = y'$. Then we have the system $v = y'$, $v' = -y^2$. The trajectories are found by solving

$$-y^2 = \frac{dv}{dy}v.$$

The solution, via separation of variables, is $y^3 = \frac{3}{2}v^2 + c$. A sample of the trajectories can be found in Figure 44.

7. The trajectories are given by

$$Y(1 - X) = \frac{dY}{dX}X(1 - Y).$$

The solution, via separation of variables, is $Y - X + c = \ln(Y/X)$. A sample of the trajectories can be found in Figure 44.

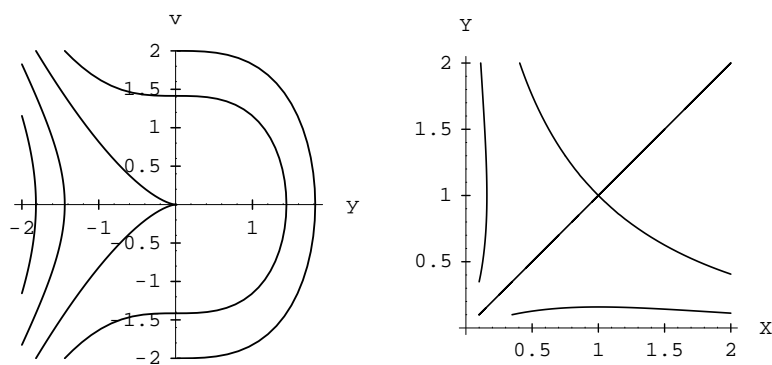

Figure 44: Exercises 5.3.5 and 5.3.7

9. The trajectories are given by

$$0.2Y(X - 1) = \frac{dY}{dX}X(1 - Y).$$

The solution, via separation of variables, is $0.2X + Y = \ln(YX^{0.2}) + c$. A sample of the trajectories can be found in Figure 45. The parameter k determines the relative amount of fluctuation of predator relative to prey. Smaller values of k make the predator fluctuations smaller.

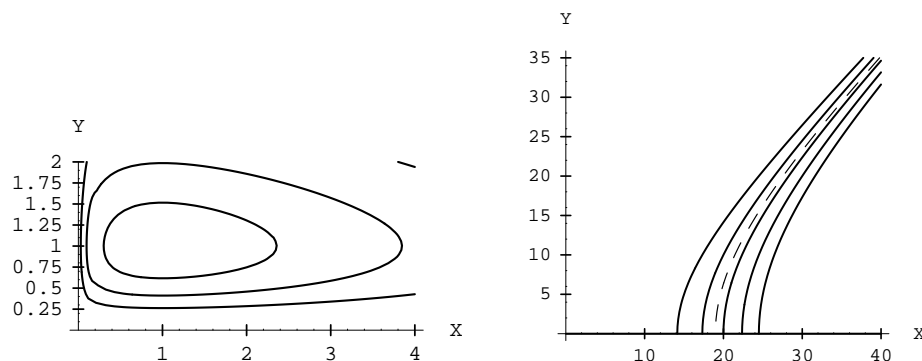

Figure 45: Exercises 5.3.9 and 5.3.11

11. (a) Let x be the first force and let y be the second force. The population of the first force decreases in proportion to the population of the second force and the second force decreases in proportion to the population of the first force present. This is consistent with the assumption that both forces are lined up and firing from a distance.
- (b) The trajectories are given by

$$-x = \frac{dy}{dx}(-y).$$

The solution of this, via separation of variables, is

$$x = \sqrt{y^2 + c}.$$

Chapter 5: Autonomous Equations and Systems

- (c) Let $x(0) = 2y(0)$. Substituting this into the solution to find c yields $c = 3y^2(0)$. Thus $x = \sqrt{y^2 + 3y^2(0)}$. Now we want to find x when $y = 0$. Thus $x = \sqrt{3}y(0) = \sqrt{3}x(0)/2$.
- (d) Let $x(0) = 33$ and $y(0) = 27$. Then $c = 33^2 - 27^2$ and when $y = 0$, $x = \sqrt{33^2 - 27^2} \approx 18.97 \approx 19$ French ships.
- (e) See Figure 45. The trajectory containing the point $(33, 27)$ is dashed.

13. (a) Since $x' = -y$,

$$x'' = -y' = x.$$

- (b) Let $x = e^r$. The characteristic polynomial is $r^2 - 1 = 0$. The characteristic values are $r = \pm 1$. The solution can be written as $x = c_1 e^t + c_2 e^{-t}$, or it can be written in terms of hyperbolic functions. Using the initial data

$$x = \frac{x_0 - y_0}{2} e^t + \frac{x_0 + y_0}{2} e^{-t} = x_0 \cosh t - y_0 \sinh t.$$

- (c) Since $x_0 < y_0$, the battle ends when $x = 0$, so we must solve

$$0 = \frac{x_0 - y_0}{2} e^t + \frac{x_0 + y_0}{2} e^{-t}$$

to find $t = \frac{1}{2} \ln((y_0 + x_0)/(y_0 - x_0))$. Alternatively, the hyperbolic formula yields $t = \operatorname{arctanh} x_0/y_0$, which is equivalent.

- (d) The battles of 23 British ships against 17 French ships and 16 French ships and 4 British ships would end at the times

$$t_B = \frac{1}{2} \ln(40/6) \approx 0.948, \quad t_F = \frac{1}{2} \ln(20/12) \approx 0.255,$$

respectively. Thus the 15 French ships from the second battle would join the first battle. This would give the French fleet numerical superiority and thus a victory in both battles.

15. We begin with the system $\frac{dS}{dt} = -rSI$, $\frac{dI}{dt} = rSI - \gamma I$. The equation for the trajectories is $dI/dS = -1 + (\gamma/r)S^{-1}$; thus,

$$-rSI = \frac{dS}{dI}(rSI - \gamma I).$$

This can be solved using separation of variables to find $I = (\gamma \ln S)/r - S + c$. Note that $\frac{dI}{dt}(0) = rS_0I_0 - \gamma I_0 = I_0(rs_0 - \gamma)$, so $rs_0 - \gamma > 0$ is necessary for I to increase.

17. (a) Let x be the height. The governing differential equation is $x'' = -g$, and the solution is $x = -gt^2/2 + c_1t + c_2$. The initial conditions are $x(0) = 3$ and $x'(0) = 0$; thus, the solution is $x = -\frac{1}{2}gt^2 + 3$. We have $x = 0$ at $t = \sqrt{6/g}$, so $\frac{dx}{dt} \sqrt{6/g} = -\sqrt{6g}$ and $v_I = \sqrt{6g} \approx 7.67$ m/s.
- (b) The governing differential equation is

$$m \frac{d^2x}{dt^2} = -mg - 15 \frac{dx}{dt}.$$

When $v_{cc} = \frac{dx}{dt}(\infty)$ is achieved, the acceleration is zero. Thus $v_{cc} = -mg/15 = -5g \approx -49$ m/s.

- (c) The governing differential equation is

$$m \frac{d^2x}{dt^2} = -mg - 1.4m \frac{dx}{dt}.$$

When $v_{oc} = \frac{dx}{dt}(\infty)$ is achieved, the acceleration is zero. Thus $v_{oc} = -g/1.4 \approx -7$ m/s.

- (d) It insures that the final speed with the parachute open is less than the maximum safe impact speed.
 (e) The governing differential equation is

$$\frac{d^2x}{dt^2} = -g - 1.4 \frac{dx}{dt}.$$

Let $v = \frac{dx}{dt}$. Then $\frac{dv}{dt} = -g - 1.4v$. Thus the equation for the trajectories is

$$v = \frac{dx}{dv}(-g - 1.4v) \approx -1.4(7 + v) \frac{dx}{dv}.$$

The solution of this equation, via separation of variables, is

$$v + 1.4x - 7 \ln |7 + v| = c.$$

See Figure 46.

- (f) When $x = 0$, we have $v = v_I = -\sqrt{6g}$, so c (the constant from the last equation) is approximately -4.85 . At the initial moment, $v = v_{cc} = -5g$, and so we can solve for x to find $x \approx 50.23$ meters.

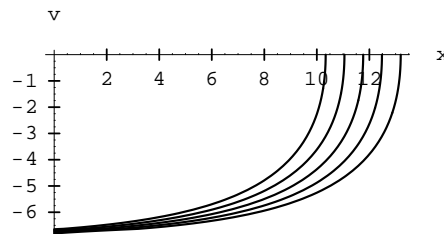

Figure 46: Exercise 5.3.17

19. (a) The equation for the trajectories is

$$w \omega = \frac{d\theta}{d\omega} (a^2 \cos \theta - 1) \sin \theta.$$

- (b) Using separation of variables, the solution is

$$\omega^2 = a^2 \sin^2 \theta + 2 \cos \theta + c.$$

- (c) See Figure 47.
 (d) See Figure 47.

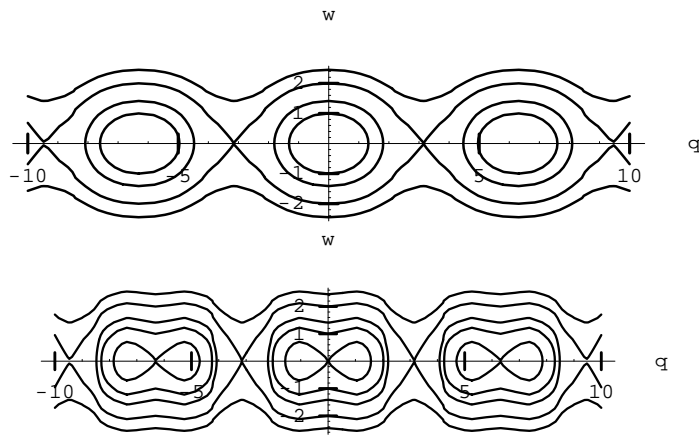

Figure 47: Exercise 5.3.19, parts (c) and (d)

- (e) Consider only the case where the initial angular velocity is 0. For the moment, consider the initial angle to be $0 \leq \theta_0 \leq \pi/2$, indicating that the bead begins below the midpoint of the hoop. In the system of part (c), the hoop is spinning at a relatively slow rate, and the trajectories indicate that the bead will oscillate from $\theta = \theta_0$ to $\theta = -\theta_0$, similar to an undamped pendulum. When the rotational velocity is greater than 1, the system becomes qualitatively different. There are equilibrium points at $\theta = \pm \arccos a^{-2}$ as well as at $\theta = 0$. With damping, the system would eventually approach one of these equilibria. In the undamped system, the bead oscillates about one of these equilibria instead. Larger initial angles allow the system to oscillate about all of the equilibria.

Section 5.4

1. In the (r, c) plane, the critical points are $(0, 0)$ and $(4, 3/2)$.
3. In the (x, y) plane, the critical points are $(n\pi, n\pi)$ for any integer n .
5. The point $(0, 0)$ is an unstable saddle point. See Figure 48.

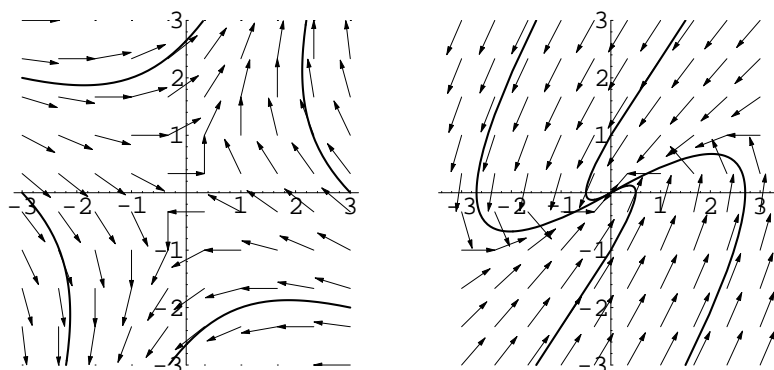

Figure 48: Exercises 5.4.5 and 5.4.7

7. The point $(0,0)$ is an asymptotically stable equilibrium point. See Figure 48.
9. The point $(0,0)$ is a stable center. See Figure 49.

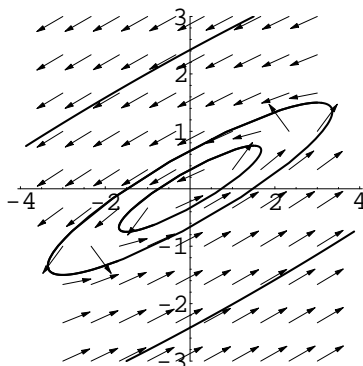

Figure 49: Exercise 5.4.9

11. (a) The critical points are $(0,0)$ and $(1,1)$.
- (b) See Figure 50.
- (c) The points $(0,0)$ and $(1,1)$ are unstable.
- (d) The saddle point is $(0,0)$.
- (e) See Figure 50.

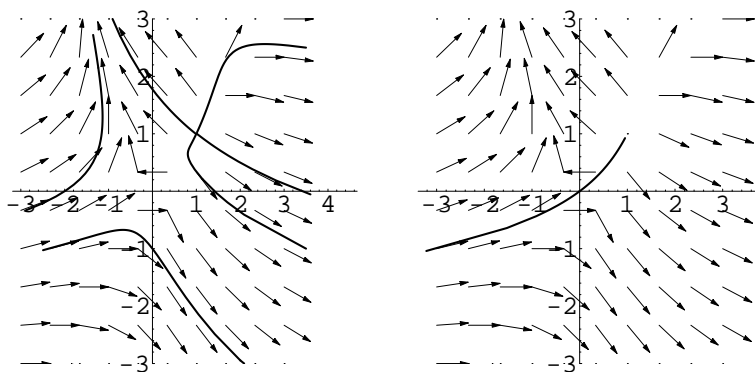

Figure 50: Exercise 5.4.11

13. (a) The critical points are $(0,0)$ and $(2,1)$.
- (b) See Figure 51.
- (c) The point $(0,0)$ is stable and $(1,1)$ is an unstable saddle point.
- (d) The saddle point is $(1,1)$.
- (e) See Figure 51.

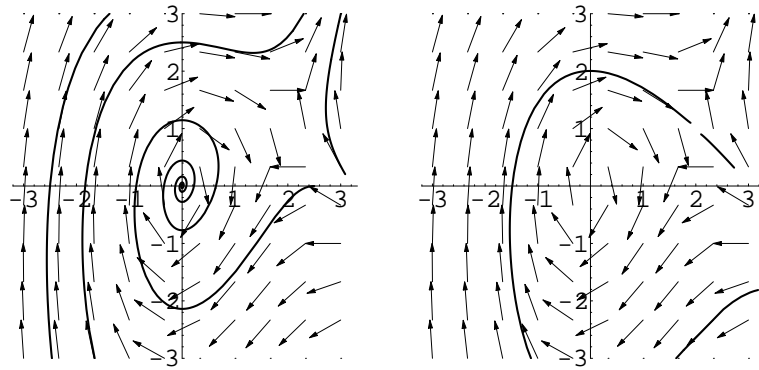

Figure 51: Exercise 5.4.13

15. Letting $v = r'$, we get

$$v' = \frac{3}{2r} - \frac{3}{2r^2} - \frac{3v^2}{2r}$$

in the (r, v) plane. The only critical point is $(1, 0)$. See Figure 52. The point $(1, 0)$ is a saddle point.

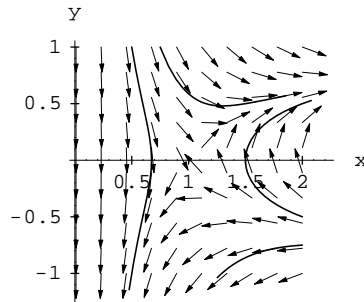

Figure 52: Exercise 5.4.15

Section 5.5

1. All trajectories in regions B and D must exit these regions. Hence, the origin must be a saddle and regions B and D must contain separatrices. See Figure 53.
3. The point $(3, 2)$ is a critical point. No conclusion is possible based on the nullclines alone. See Figure 54.

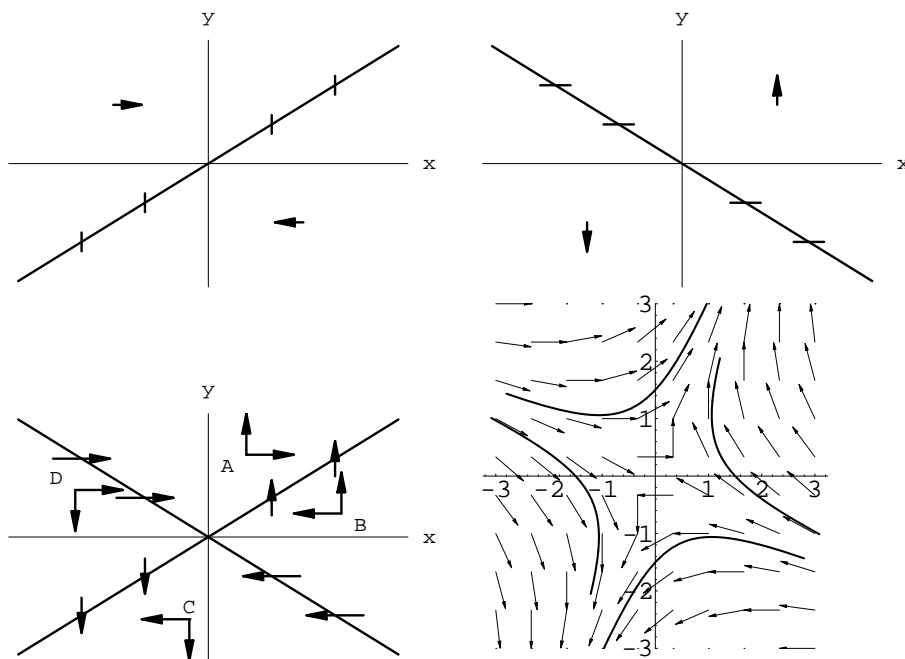

Figure 53: Exercise 5.5.1

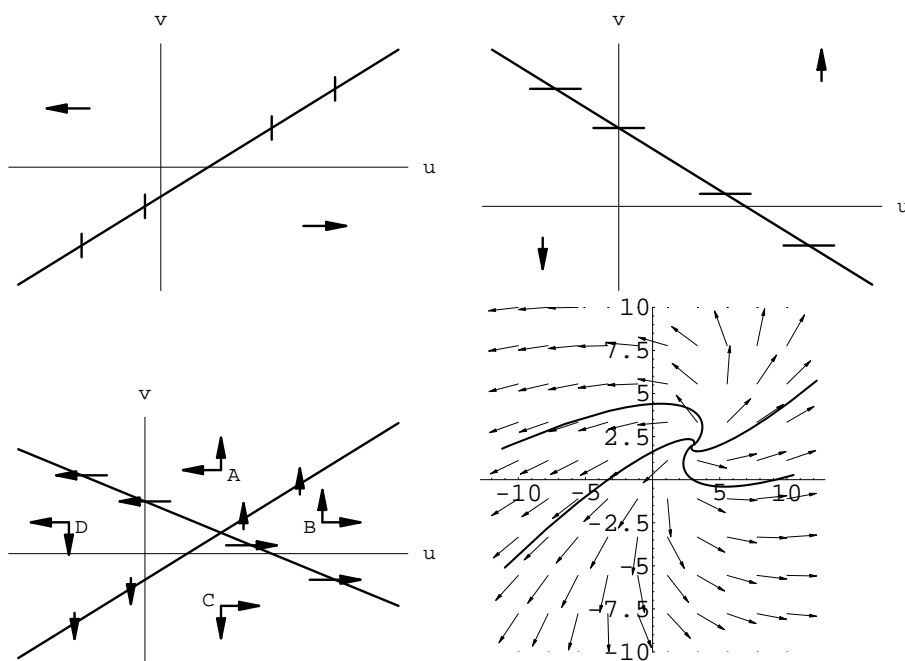

Figure 54: Exercise 5.5.3

5. All trajectories in regions D and E must exit these regions. Hence, the origin must be a saddle and regions D and E must contain separatrices. The flow in region E is sufficient to establish that $(1,1)$ is unstable, and examination of the other regions shows that it is not a saddle. See Figure 55.

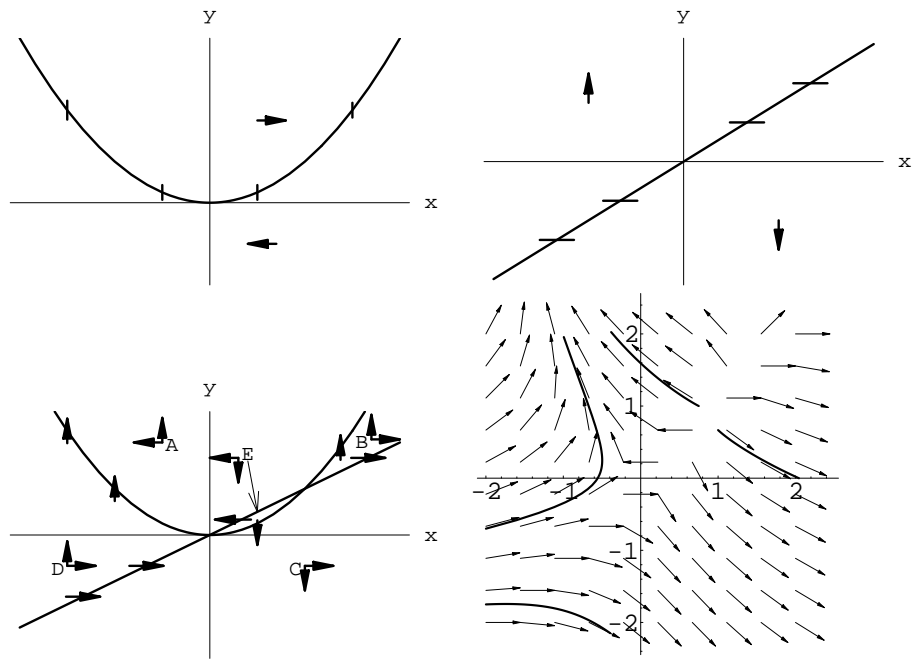

Figure 55: Exercise 5.5.5

7. All trajectories in regions B and G must exit these regions. Hence, the point $(2,1)$ must be a saddle and regions B and G must contain separatrices. No claims regarding the stability of the origin can be made from the nullclines. See Figure 56.

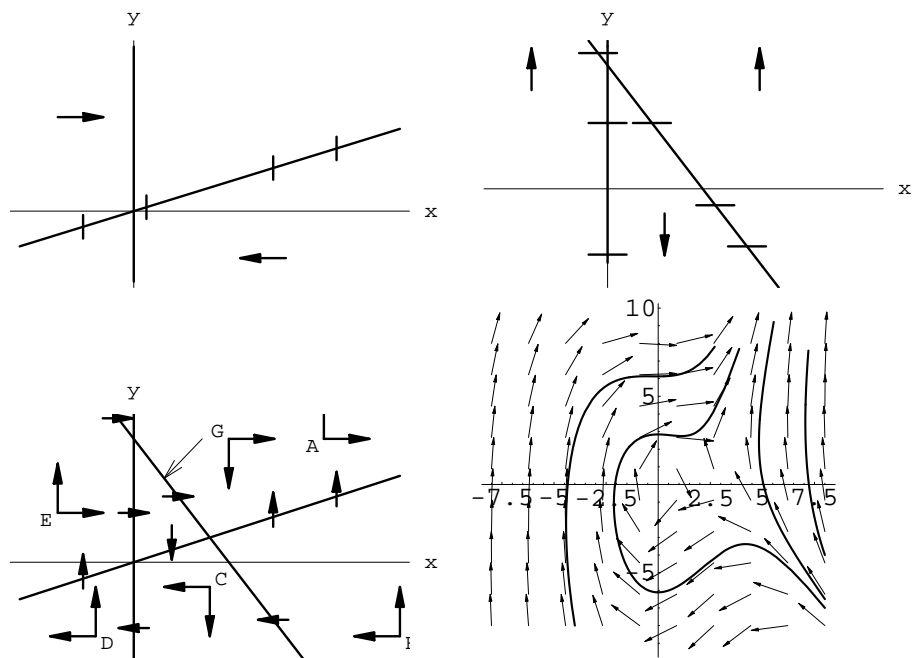

Figure 56: Exercise 5.5.7

9. The system for the bubble growth equation is

$$r' = v, \quad v' = \frac{3}{2r} - \frac{3}{2r^2} - \frac{3v^2}{2r}.$$

The nullcline diagram is shown in Figure 57. Consider first the case where the bubble size is momentarily fixed, that is, $v = 0$. If $r_0 > 1$, then the trajectory enters region B and the bubble grows at an accelerating rate. If $r_0 < 1$, then the trajectory enters the region D and the bubble rapidly disappears. Initial conditions in regions A or C eventually lead to one of the two regions B or D .

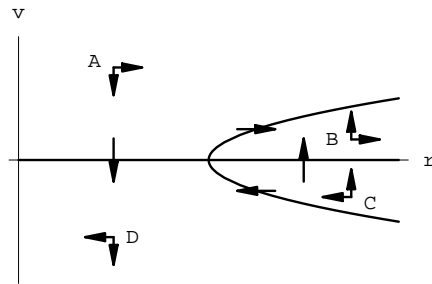

Figure 57: Exercise 5.5.9

11. (a) The nullcline diagram, shown as the first plot in Figure 58, predicts that solutions will move out of regions A and C and into regions B and D . Once in B and D , the trajectories move toward the point $(a, 0)$ or $(0, b)$. Yes, this does qualitatively describe a relationship between the two species that can be characterized as competing; indeed, the two species do not coexist for long. Depending on the initial data, one of the species will eliminate the other.
- (b) If $a < 1$ and $b < 1$, the nullcline diagram changes to the one shown in the second plot of Figure 58. Here all trajectories converge to the equilibrium point $x = (a - ab)/(1 - ab)$, $y = (b - ab)/(1 - ab)$. This describes a competing relationship in which the species share the ecological niche. In fact, there are biological arguments that indicate that this case should not occur in nature; this is called the *law of competitive exclusion*. The mathematical model is therefore flawed, but it is a flaw that is corrected simply by adding the requirements $a > 1$ and $b > 1$ to the model.

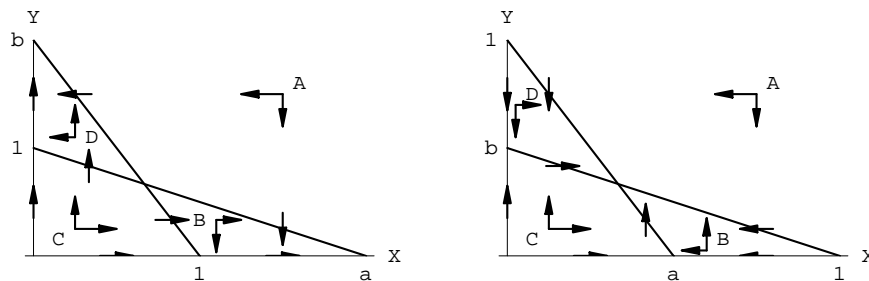

Figure 58: Exercise 5.5.11, parts (a) and (b)

Section 6.1

1. The solution of the first equation is $x = c_1 e^{3t}$. Substituting this into the second equation yields $y' = c_1 e^{3t} - 2y$. The solution of this equation is $y = \frac{1}{5} c_1 e^{3t} + c_2 e^{-2t}$.
3. (a) Differentiating the first equation yields $x'' = -3x' - y'$. Expressing y' in terms of x and x' gives us $y' = x' + 4x$. Thus $x'' = -4x' - 4x$. The characteristic polynomial is $r^2 + 4r + 4$. The characteristic value is $r = -2$; therefore,

$$x = (c_1 + c_2 t) e^{-2t}.$$

Substituting this into $y = -x' - 3x$ yields

$$y = -(c_1 + c_2 + c_2 t) e^{-2t}.$$

- (b) See Figure 59.

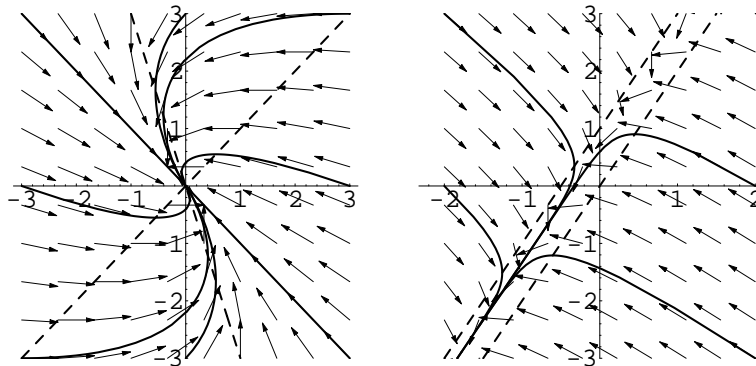

Figure 59: Exercises 6.1.3 and 6.1.5

5. (a) Differentiating the first equation yields $x'' = -2x' + y'$. Expressing y' in terms of x and x' gives us $y' = -1 - x'$. Thus $x'' = -3x' - 1$. The homogeneous problem is $x'' + 3x' = 0$. The characteristic polynomial is $r^2 + 3r$. The characteristic values are $r = 0, -3$. The solution of the homogeneous problem is $x = c_1 + c_2 e^{-3t}$. A solution to the nonhomogeneous problem is $x = -\frac{1}{3}t$; therefore,

$$x = c_1 + c_2 e^{-3t} - \frac{1}{3}t.$$

Substituting this into $y = -x' + 2x + 1$ yields

$$y = 2c_1 - c_2 e^{-3t} + \frac{2}{3} - \frac{2}{3}t.$$

- (b) See Figure 59.

7. (a) Differentiating the first equation yields $x'' = -2x' - 3y'$. Expressing y' in terms of x and x' gives us $3y' = 2x' + 13x$. Thus $x'' = -4x' - 13x$. The characteristic polynomial is $r^2 + 4r + 13$. The characteristic values are $r = -2 \pm 3i$; therefore, $x = e^{-2t}(c_1 \cos 3t + c_2 \sin 3t)$. The initial conditions show $c_1 = 4$. Substituting this into $y = -2x/3 - x'/3$ and using the initial conditions yields

$$x = e^{-2t}(4 \cos 3t - 2 \sin 3t), \quad y = e^{-2t}(2 \cos 3t + 4 \sin 3t).$$

(b) See Figure 60.

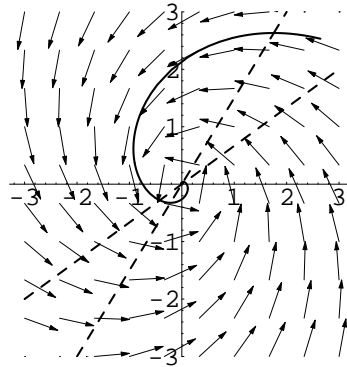

Figure 60: Exercise 6.1.7

9. Differentiating the second equation yields $y'' = -x' + 3y' = 3y' - 2y - \cos 3t$. The homogeneous problem is $y'' - 3y' + 2y = 0$. The characteristic polynomial is $r^2 - 3r + 2$. The characteristic values are $r = 1, 2$. The solution of the homogeneous problem is $y = c_1 e^t + c_2 e^{2t}$. A solution to the nonhomogeneous problem via the method of undetermined coefficients is $y_p = \frac{7}{130} \cos 3t + \frac{9}{130} \sin 3t$; therefore,

$$y = c_1 e^t + c_2 e^{2t} + \frac{7}{130} \cos 3t + \frac{9}{130} \sin 3t.$$

Substituting this into $x = 3y - y'$ yields

$$x = 2c_1 e^t + c_2 e^{2t} - \frac{3}{65} \cos 3t + \frac{24}{65} \sin 3t.$$

11. Differentiating the second equation yields $y'' = -x' + y' = 4y - e^{-2t}$. The homogeneous problem is $y'' - 4y = 0$. The characteristic polynomial is $r^2 + 4$. The characteristic values are $r = \pm 2i$. The solution of the homogeneous problem is $y = c_1 e^{2it} + c_2 e^{-2it}$. A solution to the nonhomogeneous problem via the method of undetermined coefficients is $y = \frac{1}{4} e^{-2t}$; therefore,

$$y = c_1 e^{2it} + \left(c_2 + \frac{1}{4} t \right) e^{-2it}.$$

Substituting this into $x = y' - y$ yields

$$x = c_1 e^{2it} + \left(-3c_2 + \frac{1}{4} - \frac{3}{4} t \right) e^{-2it}.$$

13. Subtracting the second equation from the first yields the equation $x'' - x' + y = 1$. Differentiating this yields $x''' - x'' + y' = 0$, or $x''' - x'' - x' + x = 0$. The characteristic polynomial is $r^3 - r^2 - r + 1 = (r - 1)^2(r + 1)$, so

$$x = (c_1 + c_2 t) e^t + c_3 e^{-t}.$$

Substituting this into $y = 1 + x' - x''$ yields

$$y = 1 - c_2 e^t - 2c_3 e^{-t}.$$

15. We begin with the system

$$\frac{dx}{dt} = R - 5r_1x + r_1y \quad \frac{dy}{dt} = 4r_1x - r_1y.$$

Nondimensionalization using Equations (2) in the text yields the system

$$\begin{aligned} X' &= 1 - 5X + Y & Y' &= 4X - Y & 0 < \tau < T \\ X' &= -5X + Y & Y' &= 4X - Y & T < \tau \end{aligned}$$

Graphical Analysis: The point $(1, 4)$ is a stable equilibrium point if $\tau < T$. The point $(0, 0)$ is a stable equilibrium point for $T < \tau$. See Figure 61. The first diagram is for $\tau < T$ and the second is for $\tau > T$. The whole discussion for Model Problem 6.1 is qualitatively the same here. One only needs to replace the point $(\frac{1}{3}, \frac{2}{3})$ by $(1, 4)$.

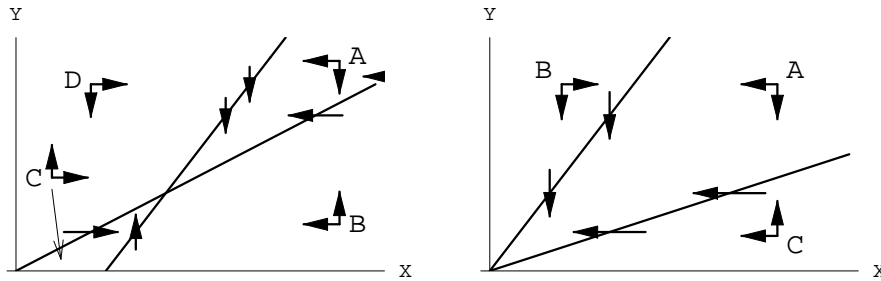

Figure 61: Exercise 6.1.15 (nullcline diagrams)

Symbolic Analysis: First we solve the system for $\tau < T$. Differentiating the second equation yields $Y'' = 4X' - Y'$. Expressing X' in terms of Y and Y' gives us $4X' = -5Y' - Y + 4$. Thus $Y'' = -6Y' - Y + 4$ with $Y(0) = Y'(0) = 0$. The homogeneous problem is $Y'' + 6Y' + Y = 0$. The characteristic polynomial is $r^2 + 6r + 1$. The characteristic values are $r = -3 \pm 2\sqrt{2}$. For convenience, let $\lambda_1 = -3 + 2\sqrt{2}$ and $\lambda_2 = -3 - 2\sqrt{2}$. The solution of the homogeneous problem is then $Y = c_1e^{\lambda_1\tau} + c_2e^{\lambda_2\tau}$. A solution of the nonhomogeneous problem is $Y = 4$. Using the initial conditions, we obtain the result

$$Y = 4 + \frac{\lambda_2}{\sqrt{2}}e^{\lambda_1\tau} - \frac{\lambda_1}{\sqrt{2}}e^{\lambda_2\tau}.$$

Substituting this into $X = \frac{1}{4}(Y' + Y)$ yields

$$X = 1 + \frac{1 + \lambda_2}{4\sqrt{2}}e^{\lambda_1\tau} - \frac{1 + \lambda_1}{4\sqrt{2}}e^{\lambda_2\tau}.$$

The sum is

$$X + Y = 5 + \frac{1 + 5\lambda_2}{4\sqrt{2}}e^{\lambda_1\tau} - \frac{1 + 5\lambda_1}{4\sqrt{2}}e^{\lambda_2\tau}.$$

Repeating the above steps for $\tau > T$, we obtain $Y'' + 6Y' + Y = 0$, which is the homogeneous equation above. The solution, using the requirement that the solutions must be continuous

at $\tau = T$, is

$$\begin{aligned}
 Y &= \frac{\lambda_2}{\sqrt{2}} \left(1 - e^{-\lambda_1 T}\right) e^{\lambda_1 \tau} - \frac{\lambda_1}{\sqrt{2}} \left(1 - e^{-\lambda_2 T}\right) e^{\lambda_2 \tau}, \\
 X &= \frac{1 + \lambda_2}{4\sqrt{2}} \left(1 - e^{-\lambda_1 T}\right) e^{\lambda_1 \tau} - \frac{1 + \lambda_1}{4\sqrt{2}} \left(1 - e^{-\lambda_2 T}\right) e^{\lambda_2 \tau}, \\
 X + Y &= \frac{1 + 5\lambda_2}{4\sqrt{2}} \left(1 - e^{-\lambda_1 T}\right) e^{\lambda_1 \tau} - \frac{1 + 5\lambda_1}{4\sqrt{2}} \left(1 - e^{-\lambda_2 T}\right) e^{\lambda_2 \tau}.
 \end{aligned}$$

See Figure 62 for graphs of X , Y and $X + Y$ with $T = 2$.

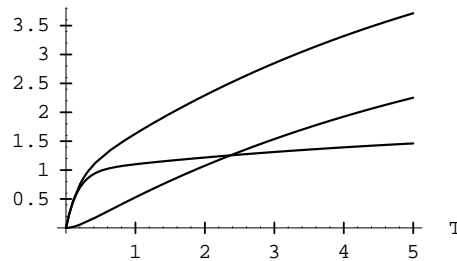

Figure 62: Exercise 6.1.15

17. (a)

$$\begin{aligned}
 \frac{dx}{dt} &= R - k_3x + k_4z - r_1x + k_2y - k_1x \\
 \frac{dy}{dt} &= k_1x - k_2y - r_2y \\
 \frac{dz}{dt} &= k_3x - k_4z
 \end{aligned}$$

(b) With the given data, the equilibrium solution is the solution of the linear system

$$\begin{pmatrix} -0.0361 & 0.0124 & 0.000035 \\ 0.0111 & -0.0286 & 0 \\ .0039 & 0 & -0.000035 \end{pmatrix} \begin{pmatrix} x \\ y \\ z \end{pmatrix} = \begin{pmatrix} -49.3 \\ 0 \\ 0 \end{pmatrix};$$

thus, $x \approx 1800$, $y \approx 699$, and $z \approx 200582$.

- (c) See Figure 63. The curve that levels off at the highest value is x , the curve that levels off at the lowest value is y , and the curve that continues to increase is z .
- (d) After just one year, the lead in the blood and tissues is close to its equilibrium value. The lead in the bones is still increasing rapidly after 100 years. (Historical evidence strongly suggests that the cause of death for former President Andrew Jackson, who lived a long life, was lead poisoning. The lead came from a bullet that hit Jackson when he fought a duel as a young man.)
- (e) The constant k_4 , which governs the only mechanism by which lead can leave the bones, is much smaller than the other parameters. Thus lead is allowed to enter the bones relatively freely but cannot exit easily. The result is a continuing rise in the amount of lead in the bones over time.

- (f) See Figure 64. The graphs here are qualitatively the same for $0 < t < 400$. However the plot of z for large t is dramatically different. The symbolic solver (on both Mathematica and Maple) overestimates the the solution and has it departing from the equilibrium point. The numerical approximation from part (c) looks more reasonable because it matches the qualitative behavior found in part (b).

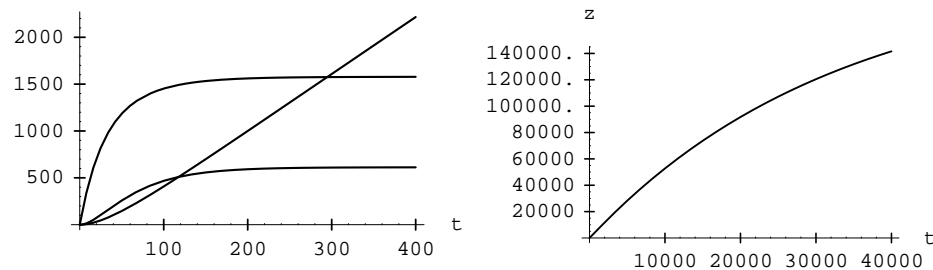

Figure 63: Exercise 6.1.17c

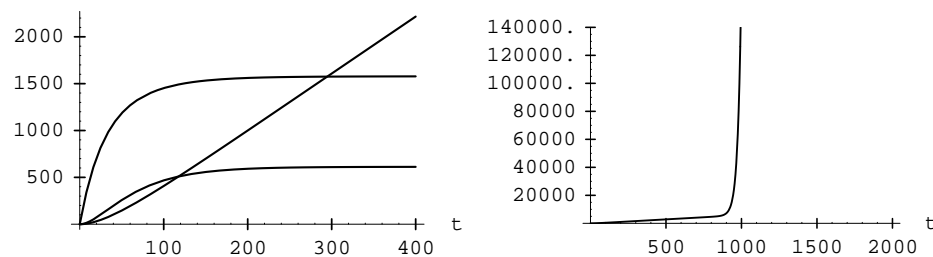

Figure 64: Exercise 6.1.17f

Section 6.2

- The null-space is $\mathbf{x} = \mathbf{0}$.

- $$\begin{pmatrix} -1 & 1 & 0 \\ -2 & 2 & 0 \\ 3 & 0 & 1 \end{pmatrix} \cong \begin{pmatrix} 1 & -1 & 0 \\ 3 & 0 & 1 \\ 0 & 0 & 0 \end{pmatrix}.$$

If $x_1 = 1$, then $x_2 = 1$ and $x_3 = -3$; hence, the null-space is $\mathbf{x} = c \begin{pmatrix} 1 \\ 1 \\ -3 \end{pmatrix}$.

- $\det(\mathbf{A} - \lambda\mathbf{I}) = \lambda^2 - 4\lambda + 3 = (\lambda - 3)(\lambda - 1)$. Thus, the eigenvalues are $\lambda = 1, 3$.

$$\mathbf{A} - \mathbf{I} = \begin{pmatrix} 0 & 0 \\ 2 & 2 \end{pmatrix} \cong \begin{pmatrix} 1 & 1 \\ 0 & 0 \end{pmatrix}, \quad \mathbf{A} - 3\mathbf{I} = \begin{pmatrix} -2 & 0 \\ 2 & 0 \end{pmatrix} \cong \begin{pmatrix} 1 & 0 \\ 0 & 0 \end{pmatrix},$$

so the corresponding eigenspaces are $c \begin{pmatrix} 1 \\ -1 \end{pmatrix}$ and $c \begin{pmatrix} 0 \\ 1 \end{pmatrix}$.

7. $\det(\mathbf{A} - \lambda\mathbf{I}) = \lambda^2 + 5\lambda + 6 = (\lambda + 3)(\lambda + 2)$. Thus, the eigenvalues are $\lambda = -2, -3$.

$$\mathbf{A} + 2\mathbf{I} = \begin{pmatrix} 1 & -2 \\ 1 & -2 \end{pmatrix} \cong \begin{pmatrix} 1 & -2 \\ 0 & 0 \end{pmatrix}, \quad \mathbf{A} + 3\mathbf{I} = \begin{pmatrix} 2 & -2 \\ 1 & -1 \end{pmatrix} \cong \begin{pmatrix} 1 & -1 \\ 0 & 0 \end{pmatrix},$$

so the corresponding eigenspaces are $c \begin{pmatrix} 2 \\ 1 \end{pmatrix}$ and $c \begin{pmatrix} 1 \\ 1 \end{pmatrix}$.

9. $\det(\mathbf{A} - \lambda\mathbf{I}) = -\lambda^3 + \lambda^2 + \lambda - 1 = -(\lambda - 1)^2(\lambda + 1)$. Thus, the eigenvalues are $\lambda = 1, -1$.

$$\mathbf{A} - \mathbf{I} = \begin{pmatrix} -7 & -1 & 2 \\ 3 & 1 & 0 \\ -14 & -2 & 4 \end{pmatrix} \cong \begin{pmatrix} 3 & 1 & 0 \\ -7 & -1 & 2 \\ 0 & 0 & 0 \end{pmatrix} \cong \begin{pmatrix} 3 & 1 & 0 \\ -4 & 0 & 2 \\ 0 & 0 & 0 \end{pmatrix} \cong \begin{pmatrix} 3 & 1 & 0 \\ -2 & 0 & 1 \\ 0 & 0 & 0 \end{pmatrix},$$

so $x_1 = 1$ implies $x_2 = -3$ and $x_3 = 2$.

$$\mathbf{A} + \mathbf{I} = \begin{pmatrix} -5 & -1 & 2 \\ 3 & 3 & 0 \\ -14 & -2 & 6 \end{pmatrix} \begin{pmatrix} 1 & 1 & 0 \\ 0 & 4 & 2 \\ 0 & 12 & 6 \end{pmatrix} \cong \begin{pmatrix} 1 & 1 & 0 \\ 0 & 2 & 1 \\ 0 & 0 & 0 \end{pmatrix},$$

so $x_2 = -1$ implies $x_1 = 1$ and $x_3 = 2$.

The corresponding eigenspaces are $c \begin{pmatrix} 1 \\ -3 \\ 2 \end{pmatrix}$ and $c \begin{pmatrix} 1 \\ -1 \\ 2 \end{pmatrix}$. This matrix is deficient.

11. $\det(\mathbf{A} - \lambda\mathbf{I}) = -\lambda^3 + 6\lambda^2 - 5\lambda - 12 = -(\lambda - 3)(\lambda - 4)(\lambda + 1)$.

Thus, the eigenvalues are $\lambda = 3, 4, -1$.

$$\mathbf{A} - 3\mathbf{I} = \begin{pmatrix} 0 & 2 & 0 \\ 2 & -3 & 0 \\ 1 & 1 & 0 \end{pmatrix} \cong \begin{pmatrix} 1 & 1 & 0 \\ 0 & 2 & 0 \\ 0 & -5 & 0 \end{pmatrix} \cong \begin{pmatrix} 1 & 0 & 0 \\ 0 & 1 & 0 \\ 0 & 0 & 0 \end{pmatrix},$$

so $x_3 = 1$ implies $x_1 = 0$ and $x_2 = 0$.

$$\mathbf{A} - 4\mathbf{I} = \begin{pmatrix} -1 & 2 & 0 \\ 2 & -4 & 0 \\ 1 & 1 & -1 \end{pmatrix} \cong \begin{pmatrix} 1 & -2 & 0 \\ 0 & 3 & -1 \\ 0 & 0 & 0 \end{pmatrix},$$

so $x_2 = 1$ implies $x_3 = 3$ and $x_1 = 2$.

$$\mathbf{A} + \mathbf{I} = \begin{pmatrix} 4 & 2 & 0 \\ 2 & 1 & 0 \\ 1 & 1 & 4 \end{pmatrix} \cong \begin{pmatrix} 2 & 1 & 0 \\ -1 & 0 & 4 \\ 0 & 0 & 0 \end{pmatrix},$$

so $x_3 = 1$ implies $x_1 = 4$ and $x_2 = -8$.

The corresponding eigenspaces are $c \begin{pmatrix} 0 \\ 0 \\ 1 \end{pmatrix}$, $c \begin{pmatrix} 2 \\ 1 \\ 3 \end{pmatrix}$, and $c \begin{pmatrix} 4 \\ -8 \\ 1 \end{pmatrix}$.

13. $\det(\mathbf{A} - \lambda\mathbf{I}) = -\lambda^3 + 6\lambda^2 - 11\lambda + 6 = -(\lambda - 1)(\lambda - 2)(\lambda - 3)$.

Thus, the eigenvalues are $\lambda = 1, 2, 3$.

$$\mathbf{A} - \mathbf{I} = \begin{pmatrix} 2 & 2 & 2 \\ 1 & 3 & 1 \\ -2 & -4 & -2 \end{pmatrix} \cong \begin{pmatrix} 1 & 1 & 1 \\ 0 & 2 & 0 \\ 0 & -2 & 0 \end{pmatrix} \cong \begin{pmatrix} 1 & 0 & 1 \\ 0 & 1 & 0 \\ 0 & 0 & 0 \end{pmatrix},$$

so $x_1 = 1$ implies $x_3 = -1$ and $x_2 = 0$.

$$\mathbf{A} - 2\mathbf{I} = \begin{pmatrix} 1 & 2 & 2 \\ 1 & 2 & 1 \\ -2 & -4 & -3 \end{pmatrix} \cong \begin{pmatrix} 1 & 2 & 1 \\ 0 & 0 & 1 \\ 0 & 0 & -1 \end{pmatrix} \cong \begin{pmatrix} 1 & 2 & 0 \\ 0 & 0 & 1 \\ 0 & 0 & 0 \end{pmatrix},$$

so $x_2 = -1$ implies $x_1 = 2$ and $x_3 = 0$.

$$\mathbf{A} - 3\mathbf{I} = \begin{pmatrix} 0 & 2 & 2 \\ 1 & 1 & 1 \\ -2 & -4 & -4 \end{pmatrix} \cong \begin{pmatrix} 1 & 1 & 1 \\ 0 & 1 & 1 \\ 0 & -2 & -2 \end{pmatrix} \cong \begin{pmatrix} 1 & 0 & 0 \\ 0 & 1 & 1 \\ 0 & 0 & 0 \end{pmatrix},$$

so $x_3 = 1$ implies $x_2 = -1$ and $x_1 = 0$.

The corresponding eigenspaces are $c \begin{pmatrix} 1 \\ 0 \\ -1 \end{pmatrix}$, $c \begin{pmatrix} 2 \\ -1 \\ 0 \end{pmatrix}$, and $c \begin{pmatrix} 0 \\ -1 \\ 1 \end{pmatrix}$.

15. $\det(\mathbf{A} - \lambda\mathbf{I}) = -\lambda^3 + 5\lambda^2 - 8\lambda + 4 = -(\lambda - 1)(\lambda - 2)^2$. Thus, the eigenvalues are $\lambda = 1, 2$.

$$\mathbf{A} - \mathbf{I} = \begin{pmatrix} 4 & -6 & -6 \\ -1 & 3 & 2 \\ 3 & -6 & -5 \end{pmatrix} \cong \begin{pmatrix} 1 & -3 & -2 \\ 0 & 6 & 2 \\ 0 & 3 & 1 \end{pmatrix} \cong \begin{pmatrix} 1 & 0 & -1 \\ 0 & 3 & 1 \\ 0 & 0 & 0 \end{pmatrix},$$

so $x_2 = -1$ implies $x_3 = 3$ and $x_1 = 3$.

$$\mathbf{A} - 2\mathbf{I} = \begin{pmatrix} 3 & -6 & -6 \\ -1 & 2 & 2 \\ 3 & -6 & -6 \end{pmatrix} \cong \begin{pmatrix} 1 & -2 & -2 \\ 0 & 0 & 0 \\ 0 & 0 & 0 \end{pmatrix},$$

so eigenvectors must satisfy $x_1 = 2x_2 + 2x_3$.

The corresponding eigenspaces are $c \begin{pmatrix} 3 \\ -1 \\ 3 \end{pmatrix}$ and $c_1 \begin{pmatrix} 2 \\ 1 \\ 0 \end{pmatrix} + c_2 \begin{pmatrix} 2 \\ 0 \\ 1 \end{pmatrix}$. This matrix is not deficient.

17. $\det(\mathbf{A} - \lambda\mathbf{I}) = -\lambda^3 + 2\lambda^2 - \lambda = -\lambda(\lambda - 1)^2$. Thus, the eigenvalues are $\lambda = 0, 1$.

$$\mathbf{A} = \begin{pmatrix} -1 & 1 & 0 \\ -2 & 2 & 0 \\ 3 & 0 & 1 \end{pmatrix} \cong \begin{pmatrix} 1 & -1 & 0 \\ 3 & 0 & 1 \\ 0 & 0 & 0 \end{pmatrix},$$

so $x_1 = 1$ implies $x_2 = 1$ and $x_3 = -3$.

$$\mathbf{A} - \mathbf{I} = \begin{pmatrix} -2 & 1 & 0 \\ -2 & 1 & 0 \\ 3 & 0 & 0 \end{pmatrix} \cong \begin{pmatrix} 1 & 0 & 0 \\ 0 & 1 & 0 \\ 0 & 0 & 0 \end{pmatrix},$$

so $x_3 = 1$ implies $x_1 = 0$ and $x_2 = 0$.

The corresponding eigenspaces are $c \begin{pmatrix} 1 \\ 1 \\ -3 \end{pmatrix}$ and $c \begin{pmatrix} 0 \\ 0 \\ 1 \end{pmatrix}$.

This matrix is deficient.

Section 6.3

Many of the exercises in this section use eigenvalues and eigenspaces from the corresponding problems in Section 6.2.

1. The linear trajectories are the eigenspaces $c\begin{pmatrix} 1 \\ -1 \end{pmatrix}$ and $c\begin{pmatrix} 0 \\ 1 \end{pmatrix}$. See Figure 65.

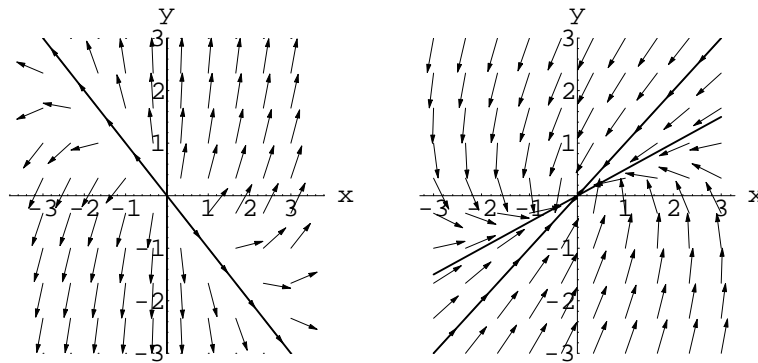

Figure 65: Exercises 6.3.1 and 6.3.3

3. The linear trajectories are the eigenspaces $c\begin{pmatrix} 2 \\ 1 \end{pmatrix}$ and $c\begin{pmatrix} 1 \\ 1 \end{pmatrix}$. See Figure 65.

5.

$$\det(\mathbf{A} - \lambda\mathbf{I}) = (2 - \lambda)(-1 - \lambda)$$

and

$$\mathbf{A} - 2\mathbf{I} = \begin{pmatrix} 0 & 1 \\ 0 & -3 \end{pmatrix} \cong \begin{pmatrix} 0 & 1 \\ 0 & 0 \end{pmatrix}, \quad \mathbf{A} + \mathbf{I} = \begin{pmatrix} 3 & 1 \\ 0 & 0 \end{pmatrix}.$$

The eigenvalues are $\lambda = 2, -1$, and the corresponding linear trajectories are vectors

$$c\begin{pmatrix} 1 \\ 0 \end{pmatrix} \quad c\begin{pmatrix} 1 \\ -3 \end{pmatrix}.$$

See Figure 66.

7.

$$\det(\mathbf{A} - \lambda\mathbf{I}) = \lambda^2 + 4\lambda + 13.$$

The eigenvalues are

$$\lambda = -2 \pm 3i.$$

Thus there are no linear trajectories. See Figure 66.

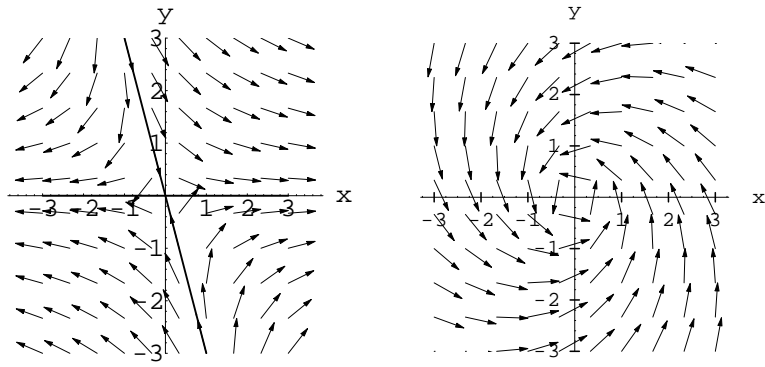

Figure 66: Exercises 6.3.5 and 6.3.7

9.

$$\det(\mathbf{A} - \lambda\mathbf{I}) = (\lambda + 4)(\lambda - 3)$$

and

$$\mathbf{A} - 3\mathbf{I} = \begin{pmatrix} -5 & 5 \\ 2 & -2 \end{pmatrix} \cong \begin{pmatrix} 1 & -1 \\ 0 & 0 \end{pmatrix}, \quad \mathbf{A} + 4\mathbf{I} = \begin{pmatrix} 2 & 5 \\ 2 & 5 \end{pmatrix} \cong \begin{pmatrix} 2 & 5 \\ 0 & 0 \end{pmatrix}.$$

The eigenvalues are $\lambda = 3, -4$, and the corresponding linear trajectories are vectors

$$c \begin{pmatrix} 1 \\ 1 \end{pmatrix}, \quad c \begin{pmatrix} 5 \\ -2 \end{pmatrix}.$$

See Figure 67.

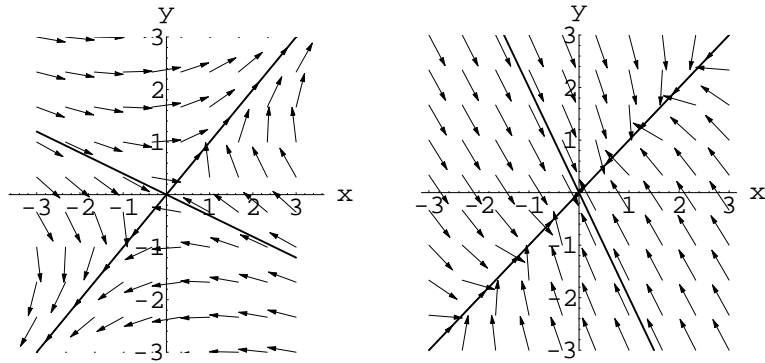

Figure 67: Exercises 6.3.9 and 6.3.11

11.

$$\det(\mathbf{A} - \lambda\mathbf{I}) = (\lambda + 7)(\lambda + 1)$$

and

$$\mathbf{A} + \mathbf{I} = \begin{pmatrix} -2 & 2 \\ 4 & -4 \end{pmatrix} \cong \begin{pmatrix} 1 & -1 \\ 0 & 0 \end{pmatrix}, \quad \mathbf{A} + 7\mathbf{I} = \begin{pmatrix} 4 & 2 \\ 4 & 2 \end{pmatrix} \cong \begin{pmatrix} 2 & 1 \\ 0 & 0 \end{pmatrix}.$$

The eigenvalues are $\lambda = -1, -7$, and the corresponding linear trajectories are vectors

$$c \begin{pmatrix} 1 \\ 1 \end{pmatrix}, \quad c \begin{pmatrix} 1 \\ -2 \end{pmatrix}.$$

See Figure 67.

13. The linear trajectories are the eigenspaces $c \begin{pmatrix} 1 \\ -3 \\ 2 \end{pmatrix}$ and $c \begin{pmatrix} 1 \\ -1 \\ 2 \end{pmatrix}$.

15. The linear trajectories are the eigenspace $c \begin{pmatrix} 3 \\ -1 \\ 3 \end{pmatrix}$ and all lines in the plane $x_1 = 2x_2 + 2x_3$.

Section 6.4

Many of the exercises in this section use the eigenvalues and eigenspaces from the corresponding problems in Sections 6.2 and 6.3.

1. The eigenvalues are $\lambda = 1, 3$ and the corresponding eigenspaces are $c \begin{pmatrix} 1 \\ -1 \end{pmatrix}$ and $c \begin{pmatrix} 0 \\ 1 \end{pmatrix}$.

The general solution is $\mathbf{x} = c_1 \begin{pmatrix} 1 \\ -1 \end{pmatrix} e^t + c_2 \begin{pmatrix} 0 \\ 1 \end{pmatrix} e^{3t}$. The initial conditions then yield

$$\mathbf{x} = 3 \begin{pmatrix} 1 \\ -1 \end{pmatrix} e^t + \begin{pmatrix} 0 \\ 1 \end{pmatrix} e^{3t}.$$

3. The eigenvalues are $\lambda = 1, 3$ and the corresponding eigenspaces are $c \begin{pmatrix} 1 \\ -1 \end{pmatrix}$ and $c \begin{pmatrix} 0 \\ 1 \end{pmatrix}$.

The general solution is

$$\mathbf{x} = c_1 \begin{pmatrix} 1 \\ -1 \end{pmatrix} e^t + c_2 \begin{pmatrix} 0 \\ 1 \end{pmatrix} e^{3t}.$$

The origin is a source. See Figure 68.

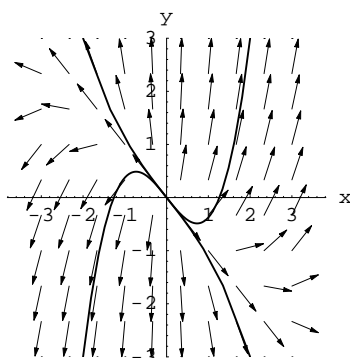

Figure 68: Exercise 6.4.3

Chapter 6: Analytical Methods for Systems

5. The eigenvalues are $\lambda = -2, -3$ and the corresponding eigenspaces are $c \begin{pmatrix} 2 \\ 1 \end{pmatrix}$ and $c \begin{pmatrix} 1 \\ 1 \end{pmatrix}$.

The general solution is

$$\mathbf{x} = c_1 \begin{pmatrix} 2 \\ 1 \end{pmatrix} e^{-2t} + c_2 \begin{pmatrix} 1 \\ 1 \end{pmatrix} e^{-3t}.$$

The origin is a sink. See Figure 69.

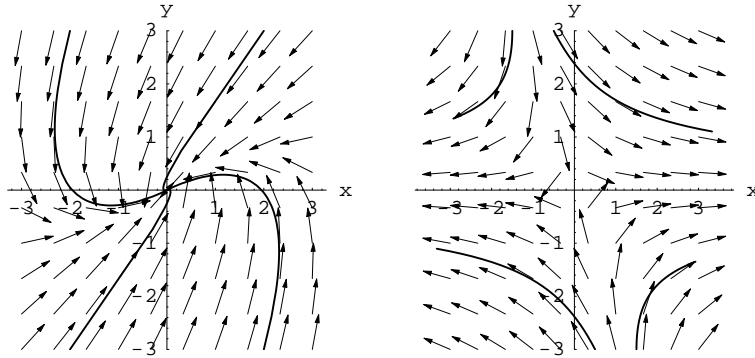

Figure 69: Exercises 6.4.5 and 6.4.7

7. The eigenvalues are $\lambda = 2, -1$ and the corresponding eigenspaces are $c \begin{pmatrix} 1 \\ 0 \end{pmatrix}$ and $c \begin{pmatrix} 1 \\ -3 \end{pmatrix}$.

The general solution is

$$\mathbf{x} = c_1 \begin{pmatrix} 1 \\ 0 \end{pmatrix} e^{2t} + c_2 \begin{pmatrix} 1 \\ -3 \end{pmatrix} e^{-t}.$$

The origin is a saddle. See Figure 69.

- 9.

$$\det \begin{pmatrix} 2 - \lambda & 1 \\ 4 & -1 - \lambda \end{pmatrix} = (\lambda - 3)(\lambda + 2).$$

Thus the eigenvalues are $\lambda = 3, -2$. The origin is a saddle. See Figure 70.

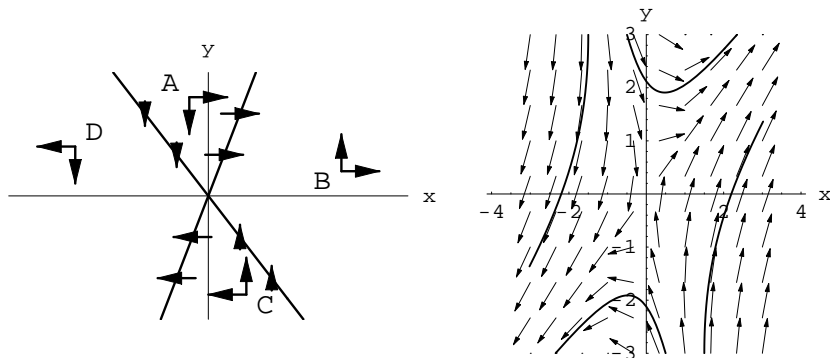

Figure 70: Exercise 6.4.9

11. The matrix is deficient, so the linear trajectories alone are not enough to construct the general solution.
13. The eigenvalues are $\lambda = 1, 2$ and the corresponding eigenspaces are

$$c \begin{pmatrix} 3 \\ -1 \\ 3 \end{pmatrix}, \quad c_1 \begin{pmatrix} 2 \\ 1 \\ 0 \end{pmatrix} + c_2 \begin{pmatrix} 2 \\ 0 \\ 1 \end{pmatrix}.$$

The general solution is

$$\mathbf{x} = c \begin{pmatrix} 3 \\ -1 \\ 3 \end{pmatrix} e^t + \left[c_1 \begin{pmatrix} 2 \\ 1 \\ 0 \end{pmatrix} + c_2 \begin{pmatrix} 2 \\ 0 \\ 1 \end{pmatrix} \right] e^{2t}.$$

15. The eigenvalues are $\lambda = 3, 4, -1$ and the corresponding eigenspaces are

$$c \begin{pmatrix} 0 \\ 0 \\ 1 \end{pmatrix}, \quad c \begin{pmatrix} 2 \\ 1 \\ 3 \end{pmatrix}, \quad c \begin{pmatrix} 4 \\ -8 \\ 1 \end{pmatrix}.$$

The general solution is

$$\mathbf{x} = c_1 \begin{pmatrix} 0 \\ 0 \\ 1 \end{pmatrix} e^{3t} + c_2 \begin{pmatrix} 2 \\ 1 \\ 3 \end{pmatrix} e^{4t} + c_3 \begin{pmatrix} 4 \\ -8 \\ 1 \end{pmatrix} e^{-t}.$$

Section 6.5

1. (a) $P(\lambda) = \lambda^2 + 4$; thus, the eigenvalues are $\lambda = \pm 2i$ and the origin is a stable center.
- (b) $\mathbf{A} - 2i\mathbf{I} = \begin{pmatrix} -2i & 1 \\ -4 & -2i \end{pmatrix} \cong \begin{pmatrix} -2i & 1 \\ 0 & 0 \end{pmatrix}$, so an eigenvector associated with $\lambda = 2i$ is $\mathbf{v} = \begin{pmatrix} 1 \\ 2i \end{pmatrix}$. From the complex solution $(\cos 2t + i \sin 2t)\mathbf{v} = \begin{pmatrix} \cos 2t + i \sin 2t \\ -2 \sin 2t + 2i \cos 2t \end{pmatrix}$, we obtain (by Algorithm 6.5.1), the general solution $\mathbf{x} = c_1 \begin{pmatrix} \cos 2t \\ -2 \sin 2t \end{pmatrix} + c_2 \begin{pmatrix} \sin 2t \\ 2 \cos 2t \end{pmatrix}$. The solution of the initial value problem is

$$\mathbf{x} = \begin{pmatrix} \cos 2t - \sin 2t \\ -2 \cos 2t - 2 \sin 2t \end{pmatrix}.$$

3. (a) $P(\lambda) = \lambda^2 - 6\lambda + 10$; thus, the eigenvalues are $\lambda = 3 \pm i$ and the origin is an unstable spiral.
- (b) $\mathbf{A} - (3+i)\mathbf{I} = \begin{pmatrix} -i & 1 \\ -1 & -i \end{pmatrix} \cong \begin{pmatrix} -i & 1 \\ 0 & 0 \end{pmatrix}$, so an eigenvector associated with $\lambda = 3 \pm i$ is $\mathbf{v} = \begin{pmatrix} 1 \\ i \end{pmatrix}$. From the complex solution

$$e^{3t}(\cos t + i \sin t)\mathbf{v} = e^{3t} \begin{pmatrix} \cos t + i \sin t \\ -\sin t + i \cos t \end{pmatrix},$$

we obtain (by Algorithm 6.5.1), the general solution

$$\mathbf{x} = e^{3t} \left[c_1 \begin{pmatrix} \cos t \\ -\sin t \end{pmatrix} + c_2 \begin{pmatrix} \sin t \\ \cos t \end{pmatrix} \right].$$

The solution of the initial value problem is

$$\mathbf{x} = e^{3t} \begin{pmatrix} 2 \cos t + \sin t \\ \cos t - 2 \sin t \end{pmatrix}.$$

5. (a) $P(\lambda) = \lambda^2 + 4\lambda + 13$; thus, the eigenvalues are $\lambda = -2 \pm 3i$ and the origin is an asymptotically stable spiral.

- (b) ${}^1 \mathbf{A} + (2 - 3i)\mathbf{I} = \begin{pmatrix} -3 - 3i & -9 \\ 2 & 3 - 3i \end{pmatrix} \cong \begin{pmatrix} 1 + i & 3 \\ 0 & 0 \end{pmatrix}$, so an eigenvector associated with $\lambda = -2 + 3i$ is $\mathbf{v} = \begin{pmatrix} -3 \\ 1 + i \end{pmatrix}$. From the complex solution

$$e^{-2t}(\cos t + i \sin t)\mathbf{v} = e^{-2t} \begin{pmatrix} -3 \cos 3t - 3i \sin 3t \\ (\cos 3t - \sin 3t) + i(\cos 3t + \sin 3t) \end{pmatrix},$$

we obtain (by Algorithm 6.5.1), the general solution

$$\mathbf{x} = e^{-2t} \left[c_1 \begin{pmatrix} -3 \cos 3t \\ \cos 3t - \sin 3t \end{pmatrix} + c_2 \begin{pmatrix} -3 \sin 3t \\ \cos 3t + \sin 3t \end{pmatrix} \right].$$

The solution of the initial value problem is

$$\mathbf{x} = e^{-2t} \begin{pmatrix} -3 \sin 3t \\ \cos 3t + \sin 3t \end{pmatrix}.$$

7. (a) $P(\lambda) = -(\lambda + 1)(\lambda^2 - 8\lambda + 20)$; thus, the eigenvalues are $\lambda = -1, 4 \pm 2i$ and the origin is unstable.

(b)

$$\mathbf{A} + \mathbf{I} = \begin{pmatrix} 3 & 2 & 0 \\ -4 & 7 & 0 \\ 0 & 0 & 0 \end{pmatrix} \cong \begin{pmatrix} 1 & 0 & 0 \\ 0 & 1 & 0 \\ 0 & 0 & 0 \end{pmatrix},$$

$$\mathbf{A} + (-4 - 2i)\mathbf{I} = \begin{pmatrix} -2 - 2i & 2 & 0 \\ -4 & 2 - 2i & 0 \\ 0 & 0 & -5 - 2i \end{pmatrix} \cong \begin{pmatrix} 1 + i & -1 & 0 \\ 0 & 0 & 1 \\ 0 & 0 & 0 \end{pmatrix};$$

thus, $\mathbf{v} = \begin{pmatrix} 0 \\ 0 \\ 1 \end{pmatrix}$ and $\mathbf{v} = \begin{pmatrix} 1 \\ 1 + i \\ 0 \end{pmatrix}$ are eigenvectors associated with $\lambda = -1$ and $\lambda = -4 + 2i$, respectively. The general solution is

$$\mathbf{x} = c_1 e^{-t} \begin{pmatrix} 0 \\ 0 \\ 1 \end{pmatrix} + c_2 e^{4t} \begin{pmatrix} \cos 2t \\ \cos 2t - \sin 2t \\ 0 \end{pmatrix} + c_3 e^{4t} \begin{pmatrix} \sin 2t \\ \cos 2t + \sin 2t \\ 0 \end{pmatrix}.$$

¹Exercise 6.5.5b appears in reprints of the text as “Solve the initial value problem $\mathbf{x}' = \begin{pmatrix} -5 & -9 \\ 2 & 1 \end{pmatrix} \mathbf{x}$, $\mathbf{x}(0) = \begin{pmatrix} 0 \\ 1 \end{pmatrix}$.” The solution given here is for the updated version of the exercise.

The initial conditions yield the result

$$\mathbf{x} = \begin{pmatrix} e^{4t}(\cos 2t - \sin 2t) \\ -2e^{4t} \sin 2t \\ e^{-t} \end{pmatrix}.$$

11. (a) The governing equations are

$$x'' = -k_1x + k_2(y - x) \quad y'' = -k_2(y - x) - k_3y$$

- (b) A differential equation for \mathbf{x} is

$$\mathbf{x}' = \begin{pmatrix} 0 & 0 & 1 & 0 \\ 0 & 0 & 0 & 1 \\ -k_1 - k_2 & k_2 & 0 & 0 \\ k_2 & -k_2 - k_3 & 0 & 0 \end{pmatrix} \mathbf{x}, \quad \mathbf{x} = \begin{pmatrix} x \\ y \\ x' \\ y' \end{pmatrix}.$$

- (c) We have

$$\det(\mathbf{A} - \lambda \mathbf{I}) = \lambda^4 + \lambda^2(k_1 + 2k_2 + k_3) + k_1k_2 + k_1k_3 + k_2k_3;$$

thus

$$\lambda^2 = \frac{-k_1 - 2k_2 - k_3}{2} \pm \frac{\sqrt{(k_1 - k_3)^2 + 4k_2^2}}{2}.$$

As long as all of the k_i are non-negative, $\lambda^2 < 0$; therefore, λ must be purely imaginary, which means that the origin is a stable center.

- (d) If $k_1 = k_3 = 1$ and $k_2 = 4$, then $\lambda^2 = -1, -9$. Thus $\lambda = \pm i, \pm 3i$. The eigenvectors associated to $\lambda = i$ and $\lambda = 3i$ respectively are

$$\begin{pmatrix} 1 \\ 1 \\ i \\ i \end{pmatrix} \quad \text{and} \quad \begin{pmatrix} 1 \\ -1 \\ 3i \\ -3i \end{pmatrix}$$

Thus the general solution is

$$\mathbf{x} = c_1 \begin{pmatrix} \cos t \\ \cos t \\ -\sin t \\ -\sin t \end{pmatrix} + c_2 \begin{pmatrix} \sin t \\ \sin t \\ \cos t \\ \cos t \end{pmatrix} + c_3 \begin{pmatrix} \cos 3t \\ -\cos 3t \\ -3 \sin 3t \\ 3 \sin 3t \end{pmatrix} + c_4 \begin{pmatrix} \sin 3t \\ -\sin 3t \\ 3 \cos 3t \\ -3 \cos 3t \end{pmatrix}.$$

Thus,

$$x = c_1 \cos t + c_2 \sin t - c_3 \cos 3t - c_4 \sin 3t, \quad y = c_1 \cos t + c_2 \sin t + c_3 \cos 3t + c_4 \sin 3t.$$

- (e) Let b be the equilibrium distance between the two masses. Then the time-dependent distance is $b + y - x = b + 2c_3 \cos 3t + 2c_4 \sin 3t$. This function oscillates with period $2\pi/3$. Similarly, let a be the distance from the left end of the system to the midpoint between the two equilibrium positions. Then the time-dependent midpoint location is $a + (y + x)/2 = c_1 \cos t + c_2 \sin t$. This function oscillates with period 2π .

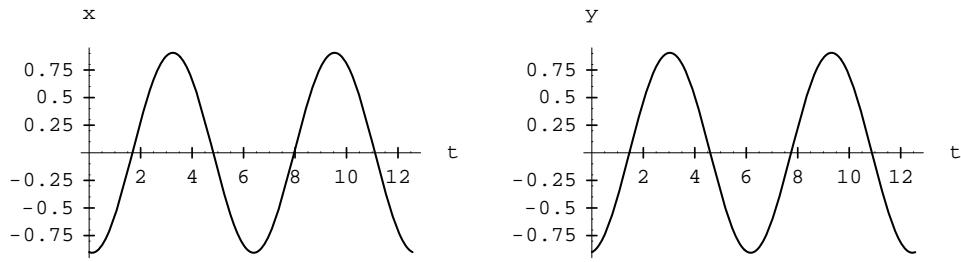

Figure 71: Exercise 6.5.11

- (f) We are given the initial conditions $x(0) = -1$ and $y(0) = 0$. Both masses are at rest up to the time when they are released, so $x'(0) = 0$ and $y'(0) = 0$. Substituting the general solution into these conditions yields the values of the four constants. The solution is

$$x = -\frac{9}{10} \cos t - \frac{1}{10} \cos 3t \quad y = -\frac{9}{10} \cos t + \frac{1}{10} \cos 3t.$$

See Figure 71.

Section 6.6

1. $P(\lambda) = (\lambda - 1)^2$; thus, the only eigenvalue is $\lambda = 1$. An eigenvector associated with this eigenvalue is $\begin{pmatrix} 1 \\ -1 \end{pmatrix}$. A generalized eigenvector w satisfies

$$\begin{pmatrix} 2 & 2 \\ -2 & -2 \end{pmatrix} \begin{pmatrix} w_1 \\ w_2 \end{pmatrix} = \begin{pmatrix} 1 \\ -1 \end{pmatrix}.$$

One such w is $w = \begin{pmatrix} \frac{1}{2} \\ 0 \end{pmatrix}$. Thus, the general solution is

$$\mathbf{x} = c_1 e^t \begin{pmatrix} 1 \\ -1 \end{pmatrix} + c_2 e^t \begin{pmatrix} t + \frac{1}{2} \\ -t \end{pmatrix}.$$

The initial conditions yield the solution

$$\mathbf{x} = e^t \begin{pmatrix} 2t + 1 \\ -2t \end{pmatrix}.$$

3. $P(\lambda) = (\lambda - 1)^2$; thus, the only eigenvalue is $\lambda = 1$. An eigenvector associated with this eigenvalue is $\begin{pmatrix} 1 \\ -1 \end{pmatrix}$. A generalized eigenvector w satisfies

$$\begin{pmatrix} 3 & 3 \\ -3 & -3 \end{pmatrix} \begin{pmatrix} w_1 \\ w_2 \end{pmatrix} = \begin{pmatrix} 1 \\ -1 \end{pmatrix}.$$

One such w is $w = \begin{pmatrix} \frac{1}{3} \\ 0 \end{pmatrix}$. Thus, the general solution is

$$\mathbf{x} = c_1 e^t \begin{pmatrix} 1 \\ -1 \end{pmatrix} + c_2 e^t \begin{pmatrix} t + 1/3 \\ -t \end{pmatrix}.$$

The initial conditions yield the solution

$$\mathbf{x} = e^t \begin{pmatrix} 2 + 21t \\ 5 - 21t \end{pmatrix}.$$

5. $P(\lambda) = (\lambda - 3)^2$; thus, the only eigenvalue is $\lambda = 3$. An eigenvector associated with this eigenvalue is $\begin{pmatrix} 1 \\ 1 \end{pmatrix}$. A generalized eigenvector w satisfies

$$\begin{pmatrix} -1 & 1 \\ -1 & 1 \end{pmatrix} \begin{pmatrix} w_1 \\ w_2 \end{pmatrix} = \begin{pmatrix} 1 \\ 1 \end{pmatrix}.$$

One such w is $w = \begin{pmatrix} 0 \\ 1 \end{pmatrix}$. Thus, the general solution is

$$\mathbf{x} = c_1 e^{3t} \begin{pmatrix} 1 \\ 1 \end{pmatrix} + c_2 e^{3t} \begin{pmatrix} t \\ t + 1 \end{pmatrix}.$$

The initial conditions yield the solution

$$\mathbf{x} = e^{3t} \begin{pmatrix} 2 + t \\ 3 + t \end{pmatrix}.$$

7. $P(\lambda) = (2 - \lambda)(\lambda - 1)^2$; thus, the eigenvalues are $\lambda = 2, 1$. Eigenvectors associated with these eigenvalues are $\begin{pmatrix} 1 \\ 0 \\ 0 \end{pmatrix}$ and $\begin{pmatrix} 1 \\ -1 \\ 1 \end{pmatrix}$ respectively. A generalized eigenvector w satisfies

$$\begin{pmatrix} 1 & 0 & -1 \\ 0 & 1 & 1 \\ 0 & -1 & -1 \end{pmatrix} \begin{pmatrix} w_1 \\ w_2 \\ w_3 \end{pmatrix} = \begin{pmatrix} 1 \\ -1 \\ 1 \end{pmatrix}.$$

One such w is $w = \begin{pmatrix} 0 \\ 0 \\ -1 \end{pmatrix}$. Thus, the general solution is

$$\mathbf{x} = c_1 e^{2t} \begin{pmatrix} 1 \\ 0 \\ 0 \end{pmatrix} + c_2 e^t \begin{pmatrix} 1 \\ -1 \\ 1 \end{pmatrix} + c_3 e^t \begin{pmatrix} t \\ -t \\ t - 1 \end{pmatrix}.$$

The initial conditions yield the solution

$$\mathbf{x} = e^{2t} \begin{pmatrix} 1 \\ 0 \\ 0 \end{pmatrix} + e^t \begin{pmatrix} -1 - 2t \\ 1 + 2t \\ 1 - 2t \end{pmatrix}.$$

9. $P(\lambda) = -(\lambda + 4)(\lambda + 3)^2$; thus, the eigenvalues are $\lambda = -4, -3$. Eigenvectors associated with these eigenvalues are $\begin{pmatrix} 0 \\ 1 \\ 0 \end{pmatrix}$ and $\begin{pmatrix} 1 \\ 1 \\ -1 \end{pmatrix}$ respectively. A generalized eigenvector w satisfies

$$\begin{pmatrix} 2 & 0 & 1 \\ 2 & 0 & 1 \\ -1 & 0 & -1 \end{pmatrix} \begin{pmatrix} w_1 \\ w_2 \\ w_3 \end{pmatrix} = \begin{pmatrix} 1 \\ 1 \\ -1 \end{pmatrix}.$$

One such w is $w = \begin{pmatrix} 1 \\ 1 \\ 0 \end{pmatrix}$. Thus, the general solution is

$$\mathbf{x} = c_1 e^{-4t} \begin{pmatrix} 0 \\ 1 \\ 0 \end{pmatrix} + c_2 e^{-3t} \begin{pmatrix} 1 \\ 1 \\ -1 \end{pmatrix} + c_3 e^{-3t} \begin{pmatrix} t+1 \\ t+1 \\ -t \end{pmatrix}.$$

The initial conditions yield the solution

$$\mathbf{x} = e^{-3t} \begin{pmatrix} 1+2t \\ 1+2t \\ 1-2t \end{pmatrix} - e^{-4t} \begin{pmatrix} 0 \\ 1 \\ 0 \end{pmatrix}.$$

11. (a)

$$\det \begin{pmatrix} -\lambda & 1 & 2 \\ 1 & -\lambda & 2 \\ -1 & -1 & -3-\lambda \end{pmatrix} = -(\lambda+1)^3.$$

(b)

$$\mathbf{A} + \mathbf{I} = \begin{pmatrix} 1 & 1 & 2 \\ 1 & 1 & 2 \\ -1 & -1 & -2 \end{pmatrix} \cong \begin{pmatrix} 1 & 1 & 2 \\ 0 & 0 & 0 \\ 0 & 0 & 0 \end{pmatrix},$$

so eigenvectors must satisfy $v_1 + v_2 + 2v_3 = 0$. The eigenvectors

$$\mathbf{u} = \begin{pmatrix} 1 \\ -1 \\ 0 \end{pmatrix}, \quad \mathbf{v} = \begin{pmatrix} 2 \\ 0 \\ -1 \end{pmatrix}$$

form a linearly independent set.

(c) ² To find a generalized eigenvector, one must find a vector \mathbf{w} and scalars c_1 and c_2 for which

$$\mathbf{x}^{(3)} = te^{-t}(c_1\mathbf{u} + c_2\mathbf{v}) + e^{-t}\mathbf{w}$$

solves the differential equation. Applying \mathbf{A} to both sides yields

$$\mathbf{A}\mathbf{x}^{(3)} = te^{-t}(c_1\mathbf{A}\mathbf{u} + c_2\mathbf{A}\mathbf{v}) + e^{-t}\mathbf{A}\mathbf{w}.$$

Differentiating both sides yields

$$\mathbf{x}^{(3)'} = e^{-t}(c_1\mathbf{u} + c_2\mathbf{v}) - te^{-t}(c_1\mathbf{u} + c_2\mathbf{v}) - e^{-t}\mathbf{w}.$$

Equating these yields the matrix equation

$$(\mathbf{A} + \mathbf{I})\mathbf{w} = c_1\mathbf{u} + c_2\mathbf{v}.$$

The augmented matrix for this equation is

$$\left(\begin{array}{ccc|c} 1 & 1 & 2 & c_1 + 2c_2 \\ 1 & 1 & 2 & -c_1 \\ -1 & -1 & -2 & -c_2 \end{array} \right) \cong \left(\begin{array}{ccc|c} 1 & 1 & 2 & -c_1 \\ 0 & 0 & 0 & 2(c_1 + c_2) \\ 0 & 0 & 0 & -(c_1 + c_2) \end{array} \right).$$

²Exercise 6.6.11c appears in reprints of the text as “Assume that a third solution has the form $\mathbf{x}^{(3)} = te^{-t}(c_1\mathbf{u} + c_2\mathbf{v}) + e^{-t}\mathbf{w}$ and find suitable scalars c_1 and c_2 and a suitable vector \mathbf{w} .” The solution given here is for the updated version of the exercise.

The matrix equation has solutions only if $c_1 + c_2 = 0$. We can choose $c_1 = -1$, $c_2 = 1$; then the equation has a solution \mathbf{w} provided $w_1 + w_2 + 2w_3 = 1$. With $w = \begin{pmatrix} 1 \\ 0 \\ 0 \end{pmatrix}$, we have the general solution

$$\mathbf{x} = c_1 e^{-t} \begin{pmatrix} 1 \\ -1 \\ 0 \end{pmatrix} + c_2 e^{-t} \begin{pmatrix} 2 \\ 0 \\ -1 \end{pmatrix} + c_3 e^{-t} \begin{pmatrix} 1+t \\ t \\ -t \end{pmatrix}.$$

(d) Using the solutions found above we have

$$\det(\Psi(0)) = \begin{vmatrix} 1 & 2 & 1 \\ -1 & 0 & 0 \\ 0 & -1 & 0 \end{vmatrix} = 1 \neq 0;$$

thus, $\Psi(0)$ is nonsingular and we have found a general solution.

(e) Substituting the general solution of part (c) into the initial conditions yields the equations $c_1 + 2c_2 + c_3 = 1$, $-c_1 = 0$, and $-c_2 = 0$. Hence, the solution is

$$\mathbf{x} = e^{-t} \begin{pmatrix} 1+t \\ t \\ -t \end{pmatrix}.$$

Section 6.7

1. (a) The critical points are $(0, 0)$ and $(\frac{4}{3}, \frac{3}{2})$.

(b)

$$J = \begin{pmatrix} -3 + 2y & 2x \\ 3y & -4 + 3x \end{pmatrix}.$$

(c)

$$J(0, 0) = \begin{pmatrix} -3 & 0 \\ 0 & -4 \end{pmatrix}, \quad J\left(\frac{4}{3}, \frac{3}{2}\right) = \begin{pmatrix} 0 & \frac{8}{3} \\ \frac{9}{2} & 0 \end{pmatrix}.$$

The first of these has eigenvalues -3 and -4 and the second has characteristic polynomial $\lambda^2 - 12$; thus, the origin for the first linearized system is a sink and the origin for the second linearized system is a saddle.

(d) By Theorem 6.7.1 the origin in the original system is asymptotically stable and the point $(\frac{4}{3}, \frac{3}{2})$ is unstable.

(e) See Figure 72.

(f) See Figure 72.

(g) The saddle at $(\frac{4}{3}, \frac{3}{2})$ is the key feature in the phase portrait. There are separatrices in the first quadrant that divide the plane into a region for which all trajectories approach the origin and a region for which trajectories move in the direction of increasing x and y .

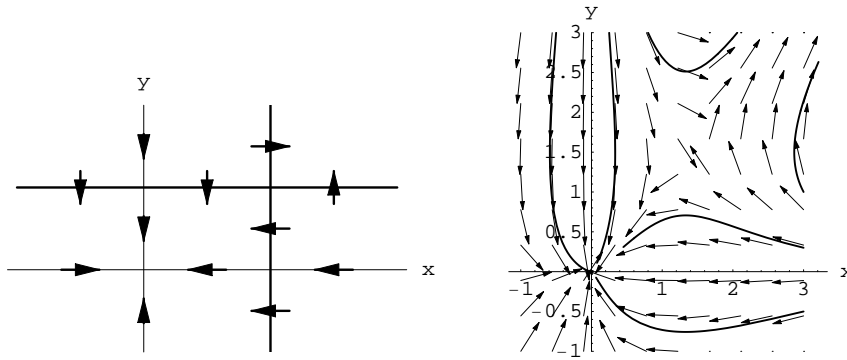

Figure 72: Exercise 6.7.1

3. (a) The critical points are $(0, 0)$, $(0, 3)$, and $(2, 0)$.

(b)

$$J = \begin{pmatrix} 2 - 2x - y & -x \\ -y & 3 - x - 2y \end{pmatrix}.$$

(c)

$$J(0, 0) = \begin{pmatrix} 2 & 0 \\ 0 & 3 \end{pmatrix}, \quad J(0, 3) = \begin{pmatrix} -1 & 0 \\ -3 & -3 \end{pmatrix}, \quad J(2, 0) = \begin{pmatrix} -2 & -2 \\ 0 & 1 \end{pmatrix}.$$

The eigenvalues are 2, 3 for the first, $-1, -3$ for the second, and $-2, 1$ for the third. The origin in the three linearized systems is a source, a sink, and a saddle, respectively.

- (d) By Theorem 6.7.1 the origin and the point $(2, 0)$ in the original system are unstable and the point $(0, 3)$ in the original system is asymptotically stable.

(e) See Figure 73.

(f) See Figure 73.

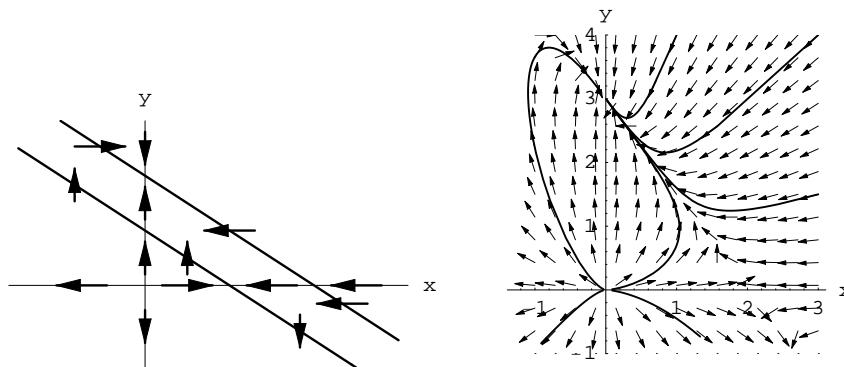

Figure 73: Exercise 6.7.3

- (g) As a competing species model, we are primarily interested in the behavior of trajectories in the first quadrant. In this region, all trajectories approach the asymptotically stable critical point $(0, 3)$. Elsewhere, the positive x axis and the y axis are separatrices. Solutions in each quadrant remain in that quadrant.

5. (a) The critical points are $(0, 0)$, $(1, 0)$, and $(-1, 0)$.

(b)

$$J = \begin{pmatrix} 0 & 1 \\ 1 - 3x^2 & -1 \end{pmatrix}.$$

(c)

$$J(0, 0) = \begin{pmatrix} 0 & 1 \\ 1 & -1 \end{pmatrix}, \quad J(1, 0) = J(-1, 0) = \begin{pmatrix} 0 & 1 \\ -2 & -1 \end{pmatrix}.$$

The first of these has eigenvalues $(-1 \pm \sqrt{5})/2$ and the other two have eigenvalues $(-1 \pm \sqrt{7}i)/2$; thus, the origin for the first linearized system is a saddle and the origin for the other linearized system is an asymptotically stable spiral.

(d) By Theorem 6.7.1, the origin in the original system is unstable and the points $(\pm 1, 0)$ are asymptotically stable.

(e) See Figure 74.

(f) See Figure 74.

(g) Trajectories in the second quadrant near the origin move down and to the right. Some move into the first quadrant, while others move into the third quadrant; hence, the nullcline diagram also shows that the origin is a saddle point and there is a separatrix in the second quadrant. Similarly, there is a separatrix in the fourth quadrant. Combination of all information shows that the points $(\pm 1, 0)$ are spiral sinks. It appears that all trajectories eventually spiral into whichever sink is on the same side of the separatrix as the trajectory.

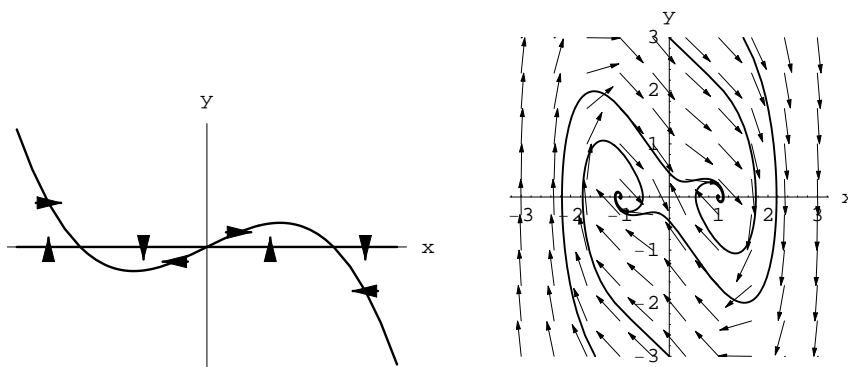

Figure 74: Exercise 6.7.5

7. ³ By Theorem 6.7.2, we need only compute the quantities

$$c_1 = -\text{tr}(\mathbf{J}) = 6, \quad c_2 = \begin{vmatrix} -2 & 0 \\ 2 & -3 \end{vmatrix} + \begin{vmatrix} -1 & 1 \\ 1 & -3 \end{vmatrix} + \begin{vmatrix} -1 & 0 \\ 1 & -2 \end{vmatrix} = 10,$$

$$c_3 = - \begin{vmatrix} -1 & 0 & 1 \\ 1 & -2 & 0 \\ 1 & 2 & -3 \end{vmatrix} = - \begin{vmatrix} -1 & 0 & 1 \\ 1 & -2 & 0 \\ 2 & 0 & -3 \end{vmatrix} = 2 \begin{vmatrix} -1 & 1 \\ 2 & -3 \end{vmatrix} = 2.$$

The quantities are all positive and $c_1 c_2 > c_3$; hence, the origin in the original nonlinear system is asymptotically stable.

11. (a) The critical points are

$$O = (0, 0, 0), \quad X = (1, 0, 0), \quad Y = (0, 1, 0), \quad XY = (1, 1, 0)$$

$$XZ = \left(\frac{1}{2}, 0, \frac{1}{2}\right), \quad YZ = \left(0, \frac{1}{2}, \frac{1}{2}\right), \quad XYZ = \left(\frac{2-r}{2+2r}, \frac{2r-1}{2+2r}, \frac{3r}{2+2r}\right)$$

The point XYZ exists only for $\frac{1}{2} < r < 2$.

(b) The Jacobian is

$$\mathbf{J} = \begin{pmatrix} 1-2x-z & 0 & -x \\ 0 & r-2ry-z & -y \\ 2z & 2z & 2x+2y-1 \end{pmatrix}.$$

(c) $\mathbf{J}(O) = \begin{pmatrix} 1 & 0 & 0 \\ 0 & r & 0 \\ 0 & 0 & -1 \end{pmatrix}$, $\mathbf{J}(X) = \begin{pmatrix} -1 & 0 & -1 \\ 0 & r & 0 \\ 0 & 0 & 1 \end{pmatrix}$, $\mathbf{J}(Y) = \begin{pmatrix} 1 & 0 & 0 \\ 0 & -r & -1 \\ 0 & 0 & 1 \end{pmatrix}$, and

$\mathbf{J}(XY) = \begin{pmatrix} -1 & 0 & -1 \\ 0 & -r & -1 \\ 0 & 0 & 3 \end{pmatrix}$. Each of these systems is unstable by Theorem 6.7.2:

$c_1 = -r < 0$ for O and X , $c_1 c_2 - c_3 = -2r^2 < 0$ for Y , and $c_3 = -3r < 0$ for XY .

(d) $\mathbf{J}(XZ) = \begin{pmatrix} -\frac{1}{2} & 0 & -\frac{1}{2} \\ 0 & r - \frac{1}{2} & 0 \\ 1 & 1 & 0 \end{pmatrix}$ and $\mathbf{J}(YZ) = \begin{pmatrix} 1 - \frac{r}{2} & 0 & 0 \\ 0 & -\frac{r}{2} & -\frac{1}{2} \\ r & r & 0 \end{pmatrix}$.

For the point XZ , we have $c_1 = 1 - r$, $c_2 = \frac{3}{4} - \frac{1}{2}r$, and $c_3 = \frac{1}{2}(\frac{1}{2} - r)$. All of these are positive, and also $c_1 c_2 > c_3$, when $r < \frac{1}{2}$. For the point YZ , we have $c_1 = r - 1$, $c_2 = \frac{2}{4}r^2$, and $c_3 = \frac{1}{2}r(\frac{1}{2}r - 1)$. All of these are positive, and also $c_1 c_2 > c_3$, when $r > 2$. The equilibrium solution YZ represents the case where prey X disappears and prey Y is in equilibrium with the predator. Since the relative growth rate of x is 1 and the relative growth rate of y is r , the condition $r > 2$ represents a significant advantage for prey Y . According to the model, the advantage for Y has to be this large for the prey X to be eliminated. Note that it is actually the predator that eliminates prey X . The large growth rate for Y means that the predator has more food, and therefore larger numbers, and this is what eliminates prey X . All of these arguments can be rewritten to apply to the case $r < \frac{1}{2}$. Note that neither prey appears to be eliminated in the moderate case $\frac{1}{2} < r < 2$.

³Exercise 6.7.7 appears in reprints of the text as “Determine the stability of the equilibrium point at the origin for the corresponding nonlinear system $\mathbf{x}' = \mathbf{f}(\mathbf{x})$, where $\mathbf{J}(0, 0) = \begin{pmatrix} -1 & 0 & 1 \\ 1 & -2 & 0 \\ 1 & 2 & -3 \end{pmatrix}$.” The solution given here is for the updated version of the exercise.

- (e) Let x_e , y_e , and z_e be the coordinates of the critical point XYZ . This critical point came from the algebraic equations

$$1 - x_e - z_e = 0, \quad r - ry_e - z_e = 0, \quad 2x_e + 2y_e - 1 = 0;$$

applying each of these in turn to the diagonal entries of the Jacobian, we have

$$\mathbf{J}(XYZ) = \begin{pmatrix} 1 - 2x_e - z_e & 0 & -x_e \\ 0 & r - 2ry_e - z_e & -y_e \\ 2z_e & 2z_e & 2x_e + 2y_e - 1 \end{pmatrix} = \begin{pmatrix} -x_e & 0 & -x_e \\ 0 & -ry_e & -y_e \\ 2z_e & 2z_e & 0 \end{pmatrix}.$$

Hence, $c_1 = x_e + ry_e > 0$, $c_2 = rx_e y_e + 2y_e z_e + 2x_e z_e > 0$, $c_3 = 2rx_e y_e z_e + 2x_e y_e z_e > 0$, and $c_1 c_2 > (x_e + ry_e)(2y_e z_e + 2x_e z_e) > x_e(2y_e z_e) + ry_e(2x_e z_e) = c_3$. Thus, XYZ is stable whenever it exists.

Section 7.1

1. $f(t) = H(t - 4)t^2$. See Figure 75.

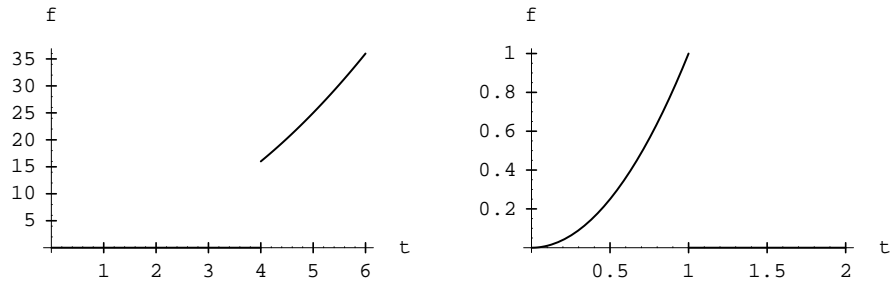

Figure 75: Exercises 7.1.1 and 7.1.3

3. $f(t) = [1 - H(t - 1)]t^2$. See Figure 75.
 5. $f(t) = [1 - H(t - 2)]t + H(t - 2)t^2$. See Figure 76.

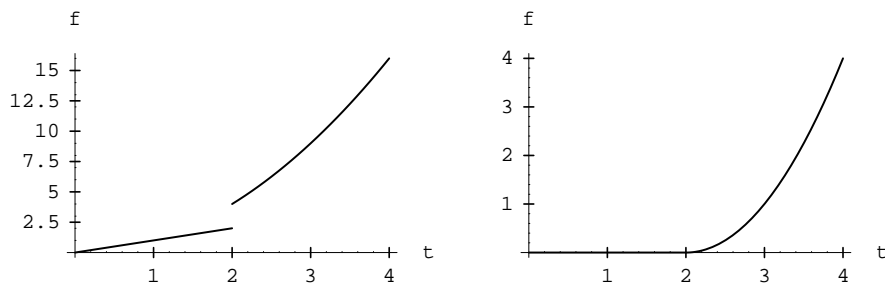

Figure 76: Exercises 7.1.5 and 7.1.7

7. $f(t) = H(t - 2)(t - 2)^2$. See Figure 76.
 9. $f(t) = [1 - H(t - 2)](2 - t) + H(t - 3)(t - 3)$. See Figure 77.

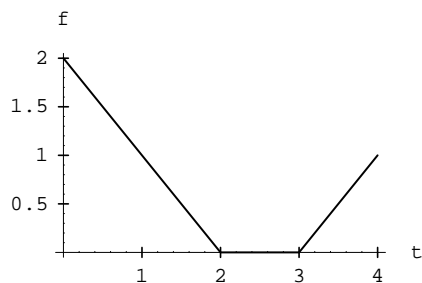

Figure 77: Exercise 7.1.9

11. See Figure 78.

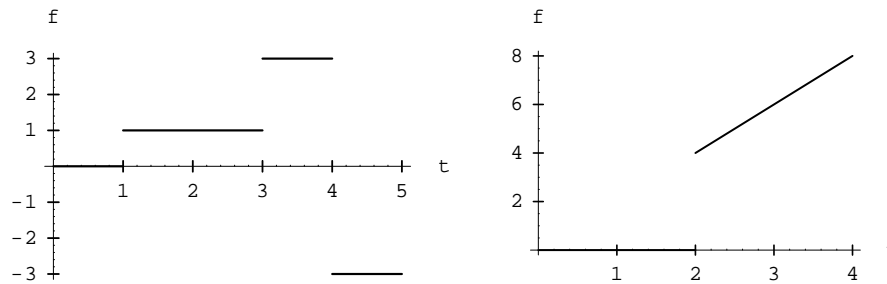

Figure 78: Exercises 7.1.11 and 7.1.13

13. See Figure 78.

15.

$$\begin{aligned} f_{\text{sq}}(t) &= [H(t) - H(t-1)] - [H(t-1) - H(t-2)] - [H(t-2) - H(t-3)] - \dots \\ &= H(t) - 2H(t-1) + 2H(t-2) - 2H(t-3) + \dots \\ &= H(t) + 2 \sum_{k=1}^{\infty} (-1)^k H(t-k). \end{aligned}$$

Section 7.2

1. $\mathcal{L}[t^4 - 3t^3 + t] = \mathcal{L}[t^4] - 3\mathcal{L}[t^3] + \mathcal{L}[t] = \frac{4!}{s^5} - 3 \cdot \frac{3!}{s^4} + \frac{1}{s^2}.$

3. $\mathcal{L}[\sin 3t + 4\sqrt{t}] = \mathcal{L}[\sin 3t] + 4\mathcal{L}[\sqrt{t}] = \frac{3}{s^2 + 9} + \frac{2\sqrt{\pi}}{s^{3/2}}.$

5. $\mathcal{L}[te^{2t}] = \int_0^{\infty} te^{t(2-s)} dt = \lim_{A \rightarrow \infty} \left[\frac{t}{2-s} - \frac{1}{(2-s)^2} \right] \Big|_0^A = \frac{1}{(s-2)^2}.$

Note that we need $s > 2$ to guarantee convergence of the integral.

7. $\mathcal{L}[f''] = \mathcal{L}[(f')'] = s\mathcal{L}[f'] - f'(0) = s\{s\mathcal{L}[f] - f(0)\} - f'(0) = s^2\mathcal{L}[f] - sf(0) - f'(0).$

9. $\mathcal{L}[H(t-1) + 2H(t-3) - 6H(t-4)] = e^{-s}\mathcal{L}[1] + 2e^{-3s}\mathcal{L}[1] - 6e^{-4s}\mathcal{L}[1]$
 $= \frac{1}{s}(e^{-s} + 2e^{-3s} - 6e^{-4s}).$

11. $\mathcal{L}[2(t-1)H(t-1)] = 2e^{-s}\mathcal{L}[t] = \frac{2}{s^2}e^{-s}.$

13. $\mathcal{L}[t^2H(t-4)] = e^{-4s}\mathcal{L}[(t+4)^2] = e^{-4s}\mathcal{L}[t^2 + 8t + 16] = e^{-4s}\left(\frac{2}{s^3} + \frac{8}{s^2} + \frac{16}{s}\right).$

15. $\mathcal{L}[t^2(1 - H(t-1))] = \mathcal{L}[t^2] - e^{-s}\mathcal{L}[(t+1)^2] = \frac{2}{s^3} - e^{-s}\left(\frac{2}{s^3} + \frac{2}{s^2} + \frac{1}{s}\right).$

Chapter 7: The Laplace Transform

$$17. \mathcal{L}[t + (t^2 - t)H(t - 2)] = \mathcal{L}[t] + e^{-2s}\mathcal{L}[(t + 2)^2 - (t + 2)] = \frac{1}{s^2} + e^{-2s}\left(\frac{2}{s^3} + \frac{3}{s^2} + \frac{2}{s}\right).$$

$$19. \mathcal{L}[(t - 2)^2 H(t - 2)] = e^{-2s}\mathcal{L}[t^2] = \frac{2}{s^3}e^{-2s}.$$

$$21. \mathcal{L}[(1 - H(t - 2))(2 - t) + H(t - 3)(t - 3)] = \mathcal{L}[2 - t] + \mathcal{L}[H(t - 2)(t - 2)] + \mathcal{L}[H(t - 3)(t - 3)] \\ = \frac{2}{s} - \frac{1}{s^2}(1 - e^{-2s} - e^{-3s}).$$

23. From Equation (5),

$$(1 - e^{-s})\mathcal{L}[f] = \int_0^1 te^{-st} dt = -\left(\frac{t}{s} + \frac{1}{s^2}\right)e^{-st}\Big|_0^1 = \frac{1}{s^2} - e^{-s}\left(\frac{1}{s^2} + \frac{1}{s}\right).$$

Thus,

$$\mathcal{L}[f] = \frac{1}{1 - e^{-s}}\left[\frac{1}{s^2} - e^{-s}\left(\frac{1}{s^2} + \frac{1}{s}\right)\right].$$

$$25. \mathcal{L}[f'''] = \mathcal{L}[(f')'] = s\mathcal{L}[f'] - f'(0) = s[s\mathcal{L}[f] - f(0)] - f'(0) = s^2F(s) - sf(0) - f'(0).$$

Section 7.3

$$1. \mathcal{L}^{-1}\left[\frac{3}{s^2 + 4}\right] = \frac{3}{2}\mathcal{L}^{-1}\left[\frac{2}{s^2 + 2^2}\right] = \frac{3}{2}\sin 2t.$$

$$3. \mathcal{L}^{-1}\left[\frac{4}{(s + 4)(s - 1)}\right] = \frac{4}{5}(e^t - e^{-4t}).$$

$$5. \mathcal{L}^{-1}\left[\frac{2(s + 1)}{(s + 1)^2 + 2^2}\right] = 2e^{-t}\cos 2t.$$

$$7. \mathcal{L}^{-1}\left[2\frac{s - 1}{(s - 1)^2 + 1} + 3\frac{1}{(s - 1)^2 + 1}\right] = 2e^t\cos t + 3e^t\sin t.$$

$$9. \mathcal{L}^{-1}\left[\frac{5}{(s + 2)^2 + 1} - 2\frac{s + 2}{(s + 2)^2 + 1}\right] = 5e^{-2t}\sin t - 2e^{-2t}\cos t.$$

11. Applying the Laplace transform to both sides of the equation yields

$$(s^2Y - s) + 3(sY - 1) + 2Y = 0;$$

thus, $Y = \frac{s + 3}{s^2 + 3s + 2}$. Taking the inverse Laplace transform, we have

$$y = \mathcal{L}^{-1}\left[\frac{s}{(s + 2)(s + 1)}\right] + 3\mathcal{L}^{-1}\left[\frac{1}{(s + 2)(s + 1)}\right] = (-e^{-t} + 2e^{-2t}) + 3(e^{-t} - e^{-2t}) \\ = 2e^{-t} - e^{-2t}.$$

13. Applying the Laplace transform to both sides of the equation yields

$$(s^4Y - s^3 + 2s) - 4Y = 0;$$

thus, $Y = \frac{s^3 - 2s}{s^4 - 4} = \frac{s}{s^2 + 2}$. Taking the inverse Laplace transform, we have $y = \cos \sqrt{2}t$.

Section 7.4

1. Since $\mathcal{L}^{-1} \left[\frac{1}{(s+2)(s-1)} \right] = -\frac{1}{3}(e^{-2t} - e^t)$,

$$\mathcal{L}^{-1} \left[\frac{e^{-2s}}{s^2 + s - 2} \right] = \frac{1}{3} \left(e^{t-2} - e^{-2(t-2)} \right) H(t-2).$$

See Figure 79.

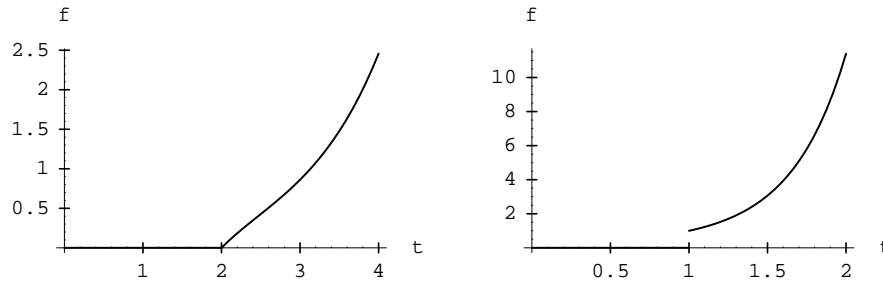

Figure 79: Exercises 7.4.1 and 7.4.3

3. Since $\mathcal{L}^{-1} \left[\frac{s-2}{(s-3)(s-1)} \right] = \mathcal{L}^{-1} \left[\frac{s}{(s-3)(s-1)} \right] - 2\mathcal{L}^{-1} \left[\frac{1}{(s-3)(s-1)} \right] = \frac{e^{3t} + e^t}{2}$,

$$\mathcal{L}^{-1} \left[\frac{(s-2)e^{-s}}{(s-3)(s-1)} \right] = \frac{1}{2} \left(e^{3(t-1)} + e^{t-1} \right) H(t-1).$$

See Figure 79.

5. Applying the Laplace transform to both sides of the equation yields

$$(s^2 Y - s) + Y = e^{-3\pi s} \frac{1}{s},$$

so

$$Y = \frac{s}{s^2 + 1} + \frac{e^{-3\pi s}}{s(s^2 + 1)}.$$

Thus,

$$y = \mathcal{L}^{-1}[Y] = \cos t + [1 - \cos(t - 3\pi)]H(t - 3\pi) = \cos t + (1 + \cos t)H(t - 3\pi).$$

See Figure 80.

7. Applying the Laplace transform to both sides of the equation yields

$$(s^2 Y - 1) + Y = \frac{1}{s^2} - e^{-\pi s} \frac{1}{s^2},$$

so

$$Y = \frac{1}{s^2 + 1} + \frac{1}{s^2(s^2 + 1)} + e^{-\pi s} \frac{1}{s^2(s^2 + 1)}.$$

Noting that $\mathcal{L}^{-1} \left[\frac{1}{s^2(s^2 + 1)} \right] = t - \sin t$, we have the result

$$y = t + [-(t - \pi) + \sin(t - \pi)]H(t - \pi) = t + (\pi - t - \sin t)H(t - \pi).$$

See Figure 80.

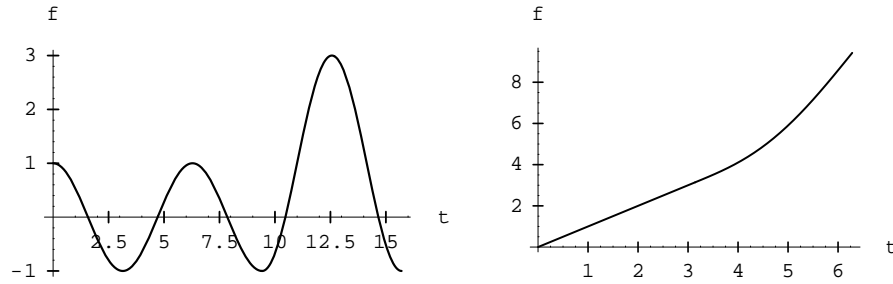

Figure 80: Exercises 7.4.5 and 7.4.7

9. Applying the Laplace transform to both sides of the equation yields

$$(s^2Y - s) + 2(sY - 1) + 2Y = e^{-\pi s},$$

so

$$Y = \frac{s + 2 + e^{-\pi s}}{(s + 1)^2 + 1} = \frac{s + 1}{s^2 + 2s + 2} + \frac{1}{(s + 1)^2 + 1} + \frac{e^{-\pi s}}{(s + 1)^2 + 1}.$$

Thus,

$$y = \mathcal{L}^{-1}[Y] = e^{-t} \cos t + e^{-t} \sin t + e^{-(t-\pi)} \sin(t - \pi)H(t - \pi).$$

See Figure 81.

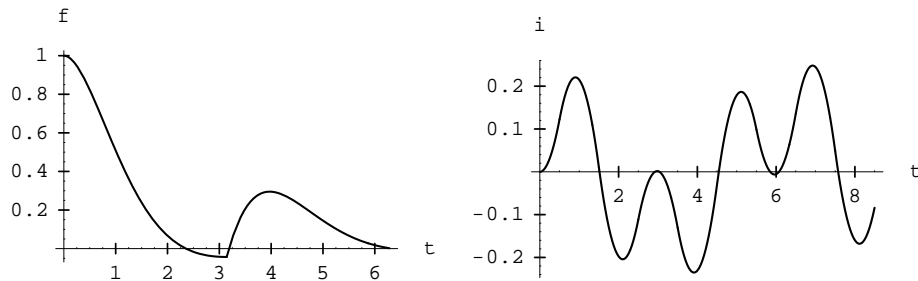

Figure 81: Exercises 7.4.9 and 7.4.11

11. The governing equations are

$$v'' + v = f_{\text{tr}}(t), \quad v(0) = 0, \quad v'(0) = 0.$$

Writing the forcing function as

$$\begin{aligned} f_{\text{tr}} &= t - (2t - 1)H(t - 1/2) + (2t - 3)H(t - 3/2) - (2t - 5)H(t - 5/2) + \dots \\ &= t + \sum_{n=1}^{\infty} (-1)^n (2t - 2n + 1)H(t - n + 1/2), \end{aligned}$$

the Laplace transform of the original problem is

$$s^2V + V = \frac{1}{s^2} + 2 \sum_{n=1}^{\infty} (-1)^n e^{-s(n-1/2)} \frac{1}{s^2}.$$

Then

$$V = \frac{1}{s^2} + 2 \sum_{n=1}^{\infty} (-1)^n e^{-s(n-1/2)} \frac{1}{s^2(s^2 + 1)},$$

from which we obtain

$$v = t - \sin t + \sum_{n=1}^{\infty} (-1)^n [2t - 2n + 1 - 2 \sin(t - n + 1/2)] H(t - n + 1/2)$$

and

$$i = v' = 1 - \cos t + 2 \sum_{n=1}^{\infty} (-1)^n [1 - \cos(t - n + 1/2)] H(t - n + 1/2).$$

See Figure 81.

Section 7.5

1. The impulse response function is the solution of the problem

$$q'' + 4q = \delta(t), \quad q(0) = q'(0) = 0.$$

Taking the Laplace transform of both sides, we have $\mathcal{L}[q] = \frac{1}{s^2 + 4}$. Thus $q = \frac{1}{2} \sin 2t$ and

$$q(t - \tau)g(\tau) = \frac{1}{2} (\sin 2t \cos 2\tau - \cos 2t \sin 2\tau) \sec 2\tau = \frac{1}{2} \sin 2t - \frac{1}{2} \cos 2t \tan 2\tau.$$

Therefore, the solution of the original problem, using Theorem 7.5.2, is

$$y = \frac{1}{2} \int_0^t (\sin 2t - \cos 2t \tan 2\tau) d\tau = \frac{1}{2} t \sin 2t + \frac{1}{4} \cos 2t \ln(\cos 2t).$$

The solution is identical to Exercise 4.6.5. The new calculation seems a little easier.

3. The impulse response function is the solution of the problem

$$q'' + 2q' + q = \delta(t), \quad q(0) = q'(0) = 0.$$

Taking the Laplace transform of both sides yields $\mathcal{L}[q] = \frac{1}{(s+1)^2}$. Thus, $q = te^{-t}$ and

$$q(t - \tau)g(\tau) = (t - \tau)e^{\tau-t}\tau^{-p}e^{-\tau} = e^{-t} (t\tau^{-p} - \tau^{1-p}).$$

The solution to the original problem, using Theorem 7.5.2, appears to be

$$y = e^{-t} \left(t \int_0^t \tau^{-p} d\tau - \int_0^t \tau^{1-p} d\tau \right).$$

However, these integrals do not converge for any positive integers p . What happened? There are two key points to note. First, the existence and uniqueness theorem guarantees a solution

Chapter 7: The Laplace Transform

for the original problem on any interval *not containing the origin*. The convolution method attempts to find a solution that satisfies the initial conditions $y(0) = 0$ and $y'(0) = 0$, and no such solution exists. Second, the results do not contradict Theorem 7.5.2, because the theorem says that the formula gives a solution *when the convolution integrals converge*. It does not say anything about the case where the convolution integrals do not converge.

5. The problem to solve is

$$v'' + v = t + \sum_{n=1}^{\infty} (-1)^n (2t - 2n + 1) H(t - n + 1/2), \quad v(0) = 0, \quad v'(0) = 0.$$

The impulse response function is $\sin t$; by Theorem 7.5.2,

$$v = q * g = t * \sin t + \sum_{n=1}^{\infty} (-1)^n (v_n(t) * \sin t), \quad v_n(t) = (2t - 2n + 1) H(t - n + 1/2).$$

The Heaviside function makes each term 0 for $t < n - \frac{1}{2}$; hence, we have

$$\begin{aligned} v &= t * \sin t + \sum_{n=1}^{\infty} (-1)^n (v_n(t) * \sin t) H(t - n + 1/2) \\ &= \int_0^t (t - \tau) \sin \tau \, d\tau + \sum_{n=1}^{\infty} (-1)^n \left[\int_0^t v_n(t - \tau) \sin \tau \, d\tau \right] H(t - n + 1/2) \\ &= t - \sin t + \sum_{n=1}^{\infty} (-1)^n \left[\int_0^t (2t - 2\tau - 2n + 1) \sin \tau \, H(t - n + 1/2 - \tau) \, d\tau \right] H(t - n + 1/2) \end{aligned}$$

To calculate the remaining integral, note that the integrand is nonzero only for $\tau < t - n + 1/2$. Since $n \geq 1$, this is a more restrictive upper limit than $\tau < t$. Hence,

$$\begin{aligned} \int_0^t (2t - 2\tau - 2n + 1) \sin \tau \, H(t - n + 1/2 - \tau) \, d\tau &= \int_0^{t-n+1/2} (2t - 2\tau - 2n + 1) \sin \tau \, d\tau \\ &= [(2\tau - 2t + 2n - 1) \cos \tau - 2 \sin \tau] \Big|_0^{t-n+1/2}, \end{aligned}$$

$$v = t - \sin t + \sum_{n=1}^{\infty} (-1)^n [2t - 2n + 1 - 2 \sin(t - n + 1/2)] H(t - n + 1/2),$$

and

$$i = v' = 1 - \cos t + 2 \sum_{n=1}^{\infty} (-1)^n [1 - \cos(t - n + 1/2)] H(t - n + 1/2).$$

This is the same solution as the one found in Exercise 7.4.11 (see Figure 81). It is a matter of taste which is more convenient.

Section 8.1

1. (a) From

$$f(t) = \begin{cases} \sin^3 \frac{\pi t}{2} & 0 \leq t < 2 \\ 0 & \text{otherwise} \end{cases},$$

we have

$$f'(t) = \begin{cases} \frac{3\pi}{2} (\sin^2 \frac{\pi t}{2}) \cos \frac{\pi t}{2} & 0 \leq t < 2 \\ 0 & \text{otherwise} \end{cases}$$

and $\lim_{t \rightarrow 2^-} f'(t) = \lim_{t \rightarrow 0^+} f'(t) = 0$. Also

$$f''(t) = \begin{cases} \frac{3\pi^2}{2} (\sin \frac{\pi t}{2}) \cos^2 \frac{\pi t}{2} - \frac{3\pi^2}{4} \sin^3 \frac{\pi t}{2} & 0 \leq t < 2 \\ 0 & \text{otherwise} \end{cases},$$

and note that $\lim_{t \rightarrow 2^-} f''(t) = \lim_{t \rightarrow 0^+} f''(t) = 0$.

- (b)

$$u = \begin{cases} \sin^3(\frac{\pi}{2}(t - \frac{x}{2})) & \frac{x}{2} \leq t < 2 + \frac{x}{2} \\ 0 & \text{otherwise} \end{cases}.$$

- (c) See Figure 82.

- (d) See Figure 82.

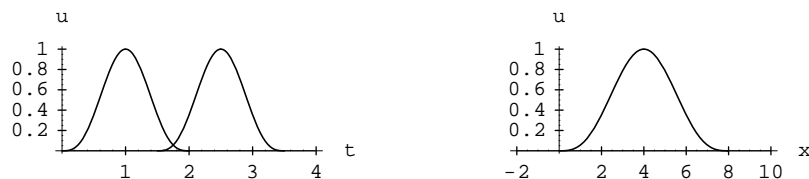

Figure 82: Exercise 8.1.1

3. (a) From

$$f(t) = \begin{cases} t - t^2 & 0 \leq t < 1 \\ 0, & \text{otherwise,} \end{cases}$$

we have

$$f'(t) = \begin{cases} 1 - 2t & 0 \leq t < 1 \\ 0, & \text{otherwise} \end{cases}$$

and note that $\lim_{t \rightarrow 1^-} f'(t) = 0$, but $\lim_{t \rightarrow 0^+} f'(t) = 1$. f' (and also f'') is not continuous at 0, so Theorem 8.1.1 does not apply. Similarly, f'' is not continuous at 1. There will be a solution that is not strictly valid at points of discontinuity.

- (b)

$$u = \begin{cases} t - \frac{x}{2} - (t - \frac{x}{2})^2 & \frac{x}{2} \leq t < 1 + \frac{x}{2} \\ 0 & \text{otherwise.} \end{cases}$$

- (c) See Figure 83.

- (d) See Figure 83.

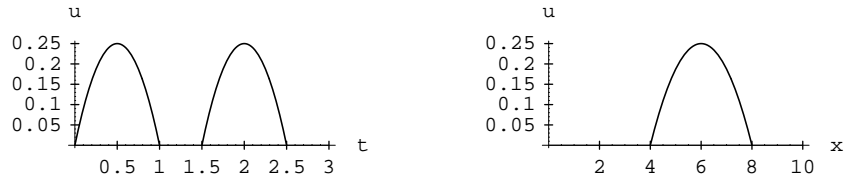

Figure 83: Exercise 8.1.3

5. (a) From

$$f(t) = \begin{cases} (1 - \cos \pi t)^3 & 0 \leq t < 2 \\ 0 & \text{otherwise} \end{cases},$$

we have

$$f'(t) = \begin{cases} 3\pi(1 - \cos \pi t)^2 \sin \pi t & 0 \leq t < 2 \\ 0 & \text{otherwise} \end{cases}$$

and $\lim_{t \rightarrow 2^-} f'(t) = \lim_{t \rightarrow 0^+} f'(t) = 0$. Also

$$f''(t) = \begin{cases} 6\pi(1 - \cos \pi t)(\sin \pi t)^2 + 3\pi^2(1 - \cos \pi t)^2 \cos \pi t & 0 \leq t < 2 \\ 0 & \text{otherwise} \end{cases}$$

and $\lim_{t \rightarrow 2^-} f''(t) = \lim_{t \rightarrow 0^+} f''(t) = 0$.

(b)

$$u = \begin{cases} (1 - \cos \pi(t - x))^3 & x \leq t < 2 + x \\ 0 & \text{otherwise} \end{cases}.$$

(c) See Figure 84.

(d) See Figure 84.

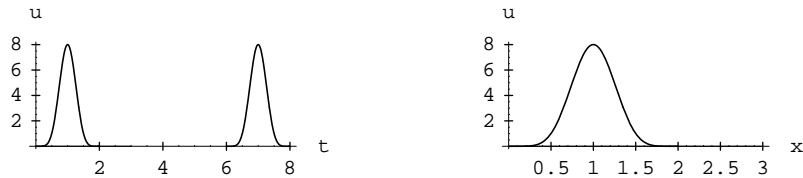

Figure 84: Exercise 8.1.5

7. We seek solutions of the form $u(x, t) = f(z(x, t))$, where $z = x - vt$. Substituting this into the heat equation gives us $-vf' = kf''$. Solving for f , we get $f(z) = c_1 - c_2e^{-vz/k}$. There exist traveling waves with wave forms

$$f(x) = c_1 + c_2e^{ax},$$

with speed $v = -ak$.

9. (a) Given $u(r, t) = g(r)f(z(r, t))$, with $z = r - vt$, we have $u_t = -vgf'$, $u_{tt} = v^2gf''$, $u_r = g'f + gf'$, $(ru_r)_r = r(g''f + 2g'f' + gf'') + (g'f + gf')$. Substituting these results into the radially symmetric wave equation yields the equation

$$(c^2 - v^2)gf'' + c^2 \left(2g' + \frac{g}{r}\right) f' + c^2 \left(g'' + \frac{g'}{r}\right) f = 0.$$

(b) $v = \pm c$.

(c) From the f' coefficient, we have $g' + g/(2r) = 0$, which has solutions $g = Ar^{-1/2}$ for any constant A . But then $0 = rg'' + g' = \frac{1}{4}Ar^{-3/2}$ requires $A = 0$. Hence, $g \equiv 0$ and no non-zero functions of the form $g(r)f(r-vt)$ solve the radially symmetric wave equation.

11. (a) Given $u(x, t) = vf(z)$, with $z = x - vt$, we have $u_t = -v^2 f'$, $u_x = vf'$, and $u_{xxx} = vf'''$. Substituting these results into the Korteweg-deVries differential equation yields the equation

$$f''' + 6vf f' - vf' = 0.$$

(b) Integrating the equation from part (a) yields

$$f'' + 3vf^2 - vf = 0,$$

where the integration constant is 0 because the function and its derivatives are 0 as $z \rightarrow \infty$. Now multiplying by $2f'$ yields $2f'f'' + 6vf^2 f' - 2vf f' = 0$, and integrating again gives us

$$(f')^2 + 2vf^3 - vf^2 = 0,$$

where again the integration constant is 0.

(c) Substituting $f'(0) = 0$ into the first-order equation for f yields the initial condition $f(0) = \frac{1}{2}$.

(d) The peak of the wave is at $z = 0$ by construction, so we have $f' < 0$ for $z > 0$ and $f' > 0$ for $z < 0$ (note that $f' = 0$ can only occur when $f = \frac{1}{2}$, so there can be no other critical points). Now consider the pair of equations $f' = \pm\sqrt{v}f\sqrt{1-2f}$. Separating variables and integrating from $(0, \frac{1}{2})$ to (z, f) , we have

$$\pm\sqrt{v}z = \pm \int_0^z \sqrt{v} dZ = \int_{1/2}^f \frac{dF}{F\sqrt{1-2F}} = -2 \int_0^{\sqrt{1-2f}} \frac{d\phi}{1-\phi^2} = -2 \operatorname{arctanh} \sqrt{1-2f}.$$

Upon rearrangement, we have the solution

$$u = vf(z) = \frac{v}{2} \operatorname{sech}^2 \frac{\sqrt{v}z}{2},$$

where $\operatorname{sech} x = 1/\cosh x$. The wave speed can be any positive value.

(e) See Figure 85.

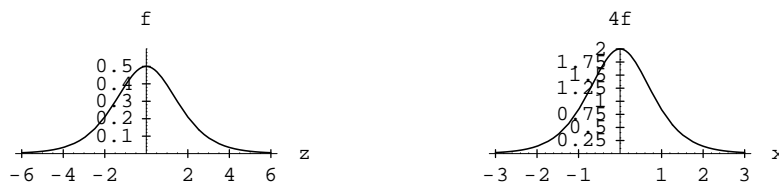

Figure 85: Exercise 8.1.11

Section 8.2

1. (a) Taking $C = 0$, we have $f(x) = g(x) = \frac{1}{1+x^2}$. The solution is

$$u = f(x-t) + g(x+t) = \frac{1}{1+(x-t)^2} + \frac{1}{1+(x+t)^2}.$$

- (b) See Figure 86.

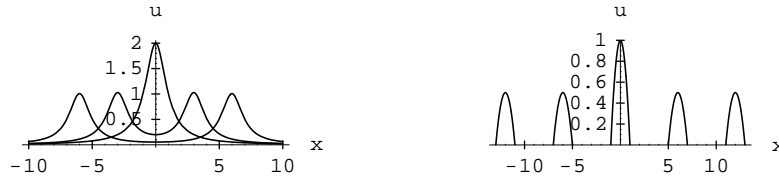

Figure 86: Exercises 8.2.1 and 8.2.3

3. (a) Taking $C = 0$, we have

$$f(x) = g(x) = \frac{1}{2} \begin{cases} 1-x^2 & -1 \leq x \leq 1 \\ 0 & \text{otherwise} \end{cases}.$$

The solution is

$$u = \begin{cases} \frac{1}{2}(1-(x-2t)^2), & 2t-1 \leq x \leq 2t+1 \\ 0, & \text{otherwise} \end{cases} + \begin{cases} \frac{1}{2}(1-(x+2t)^2), & -2t-1 \leq x \leq -2t+1 \\ 0, & \text{otherwise.} \end{cases}$$

- (b) See Figure 86.

5. (a) Taking $C = 0$, we have $-f(x) = g(x) = \frac{1}{2} \int_0^x \frac{s}{s^2+1} ds = \frac{1}{4} \ln(1+x^2)$. The solution is

$$u = f(x-t) + g(x+t) = \frac{1}{4} \ln \left(\frac{1+(x+t)^2}{1+(x-t)^2} \right).$$

- (b) See Figure 87.

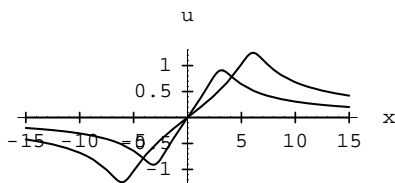

Figure 87: Exercise 8.2.5

7. (a)

$$f(x) = \frac{1}{1+x^2} - \frac{1}{4} \ln(1+x^2), \quad g(x) = \frac{1}{1+x^2} + \frac{1}{4} \ln(1+x^2).$$

See Figure 88.

(b)

$$u(x, t) = \frac{1}{1+(x-t)^2} + \frac{1}{1+(x+t)^2} + \frac{1}{4} \ln \left(\frac{1+(x+t)^2}{1+(x-t)^2} \right).$$

See Figure 88.

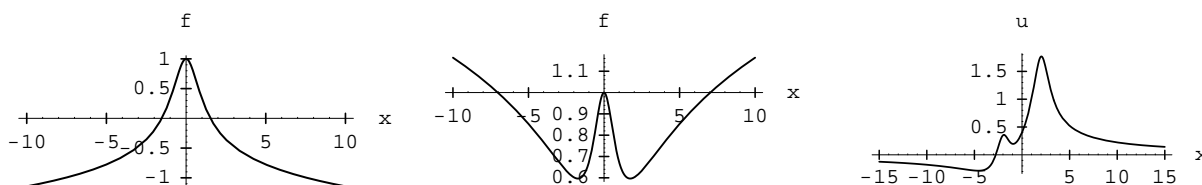

Figure 88: Exercise 8.2.7

9. (a) Assume $u(x, t) = f(z)$ with $z = x/\sqrt{4kt}$. Then

$$u_t = -\frac{x}{4t\sqrt{kt}} f' = -\frac{z}{2t} f', \quad u_{xx} = \frac{1}{4kt} f''.$$

Substituting these results into the heat equation gives us

$$f'' + 2zf' = 0,$$

which is consistent with the assumption $u = f(z)$.(b) The equation for f is a first-order separable equation for f' , with solution $f' = Ce^{-z^2}$. This solution can also be written as $f' = B \operatorname{erf}'(z)$; hence,

$$f(z) = A + B \operatorname{erf} z.$$

(c) We've already seen that $u = A + B \operatorname{erf} z$ solves the differential equation. The boundary and initial conditions then require

$$g(t) = u(0, t) = f(0) = A, \quad f(x) = u(x, 0) = f(\infty) = A + B.$$

The solution we have found works only with very specific initial and boundary conditions; hence, it is not a general solution.

Section 8.3

1. Since $\nu = 440 = \frac{\sqrt{T}}{126\sqrt{\rho}}$, and $c = \sqrt{T/\rho}$, we have $c = 554.4$ m/s.

5. Letting $u(x, t) = f(x)g(t)$ leads to the equation

$$\frac{f''}{f} = \frac{g'}{kg} = \sigma$$

for some constant σ . The waveform problem is

$$f'' = \sigma f, \quad f(0) = 0, \quad f(L) = 0,$$

which is the same [Equation (6) in the text] as for the vibrating string. The solution of this problem is $f_n = B_n \sin(n\pi x/L)$ [Equation (10)]. The amplitude equation is

$$g' = -\frac{n^2\pi^2 k}{L^2}g, \quad g(0) = 1,$$

and the solution is $g = e^{-n^2\pi^2 kt/L^2}$. The heat flow modes are

$$B_n e^{-n^2\pi^2 kt/L^2} \sin \frac{n\pi x}{L}.$$

7. The boundary conditions imply that the temperature at $x = 0$ is fixed at 0 and there is no heat flow through the end of the rod at $x = L$. Letting $u(x, t) = f(x)g(t)$ and substituting this into the heat equation gives us

$$\frac{f''}{f} = \frac{g'}{kg} = \sigma$$

for some constant σ . The waveform problem is

$$f'' = \sigma f, \quad f(0) = 0, \quad f'(L) = 0.$$

If $\sigma > 0$ then $f = 0$. If $\sigma = 0$, then $f = 0$. If $\sigma = -\lambda^2 < 0$, then we have

$$f = A \cos \lambda x + B \sin \lambda x, \quad f(0) = 0, \quad f'(L) = 0.$$

The first boundary condition forces $A = 0$, and the second results in the equation $\cos \lambda L = 0$, or $\lambda L = (n + \frac{1}{2})\pi$, for any positive integer n . Thus, $\lambda = (n + \frac{1}{2})\pi/L$ and the waveforms are $f_n(x) = B_n \sin([n + \frac{1}{2}]\pi x/L)$. The amplitude problem is

$$g' = \sigma k g, \quad g(0) = 1,$$

with $\sigma = -[(n + \frac{1}{2})\pi/L]^2$, and the solution is $g = e^{-(n+\frac{1}{2})^2\pi^2 kt/L^2}$. The heat flow modes are

$$B_n e^{-(n+\frac{1}{2})^2\pi^2 kt/L^2} \sin \frac{(n + \frac{1}{2})\pi x}{L}.$$

9. Substituting $u(r, t) = f(r)g(t)$ into the differential equation gives us

$$\frac{g''}{c^2 g} = \frac{r f'' + 2f'}{r f} = k$$

for some constant k . Assuming $k = -\lambda^2$ yields the problem

$$r f'' + 2f' + \lambda^2 r f = 0, \quad f(a) = 0, \quad |f(0)| < \infty.$$

Now suppose $w(r) = rf(r)$. Then $w' = rf' + f$ and $w'' = rf'' + 2f'$. The new waveform problem is

$$w'' + \lambda^2 w = 0, \quad w(a) = 0, \quad \lim_{r \rightarrow 0} \left| \frac{w(r)}{r} \right| < \infty.$$

The differential equation has solution $w = A \cos \lambda r + B \sin \lambda r$, the boundedness condition requires $A = 0$, and the boundary condition at a then requires $\sin \lambda a = 0$, or $\lambda = n\pi/a$, for all positive integers n . The waveforms are $w_n = B_n \sin(n\pi r/a)$, or

$$f_n = \frac{B_n}{r} \sin \frac{n\pi r}{a}.$$

The problem for the amplitude function is then

$$g_n'' + \frac{n^2 \pi^2 c^2}{a^2} g_n = 0, \quad g_n(0) = 1, \quad g_n'(0) = 0;$$

hence, $g_n = \cos(n\pi ct/a)$ and the vibration modes are

$$\frac{B_n}{r} \cos \frac{n\pi ct}{a} \sin \frac{n\pi r}{a}.$$

It is also necessary to consider nonnegative values for k . If $k = 0$, then $rf'' + 2f' = 0$, which has solution $f = c_1 + c_2/r$, and the boundary conditions force $f = 0$. If $k = \lambda^2$, then the solutions are modified Bessel functions, which cannot satisfy the boundary conditions.

Section 8.4

5. (a) The solution is

$$u(x, t) = \sum_{n=1}^{\infty} b_n \cos n\pi t \sin n\pi x, \quad b_n = 2 \int_0^1 x(1-x) \sin n\pi x \, dx.$$

We have $p(x) = x - x^2$, $p'(x) = 1 - 2x$, $p''(x) = -2$, and then

$$\begin{aligned} b_n &= \frac{2}{n\pi} [p(0) - (-1)^n p(1)] + \frac{1}{n\pi} a'_n = 0 + \frac{1}{n\pi} \left(-\frac{1}{n\pi} b_n'' \right) \\ &= -\frac{2}{n^3 \pi^3} [p''(0) - (-1)^n p''(1)] = \frac{4[1 - (-1)^n]}{n^3 \pi^3}. \end{aligned}$$

- (b) See Figure 89.

7. (a) The solution is

$$u(x, t) = \sum_{n=1}^{\infty} b_n \cos 2\pi nt \sin n\pi x, \quad b_n = 2 \int_0^1 (2x^3 - 3x^2 + x) \sin n\pi x \, dx.$$

We have $p(x) = 2x^3 - 3x^2 + x$, $p'(x) = 6x^2 - 6x$, $p''(x) = 12x - 6$, $p''' = 12$, and then

$$\begin{aligned} b_n &= \frac{2}{n\pi} [p(0) - (-1)^n p(1)] + \frac{1}{n\pi} a'_n = 0 + \frac{1}{n\pi} \left(-\frac{1}{n\pi} b_n'' \right) \\ &= -\frac{2}{n^3 \pi^3} [p''(0) - (-1)^n p''(1)] + \frac{1}{n^3 \pi^3} a_n''' = \frac{12[1 + (-1)^n]}{n^3 \pi^3}. \end{aligned}$$

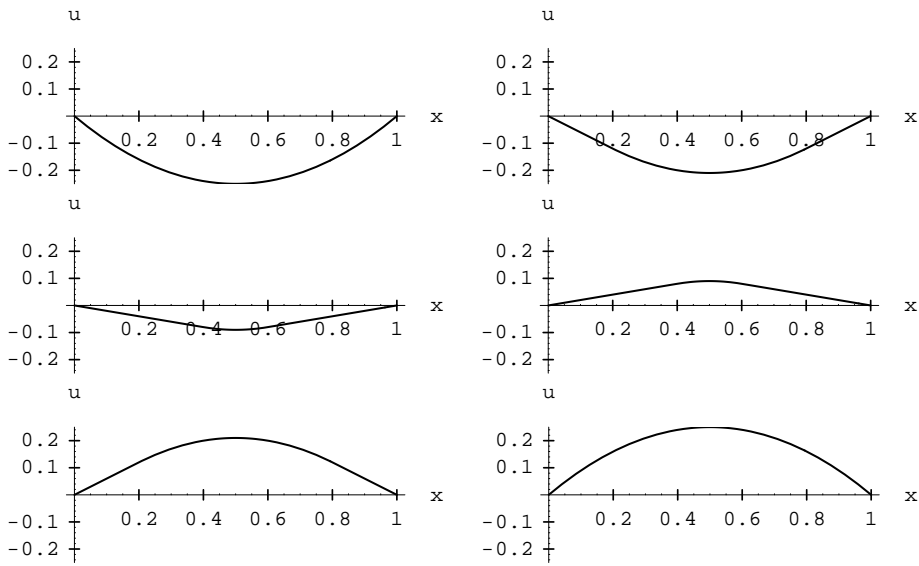

Figure 89: Exercise 8.4.5

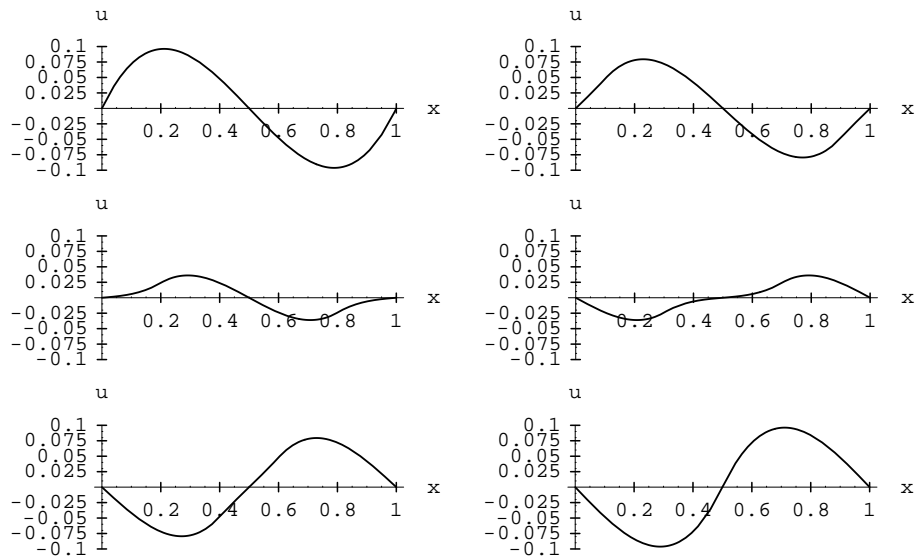

Figure 90: Exercise 8.4.7

(b) See Figure 90.

9. (a) The solution is

$$u(x, t) = \sum_{n=1}^{\infty} b_n \cos n\pi t \sin n\pi x,$$

where

$$\begin{aligned}
 b_n &= 2 \int_0^{0.9} \frac{5x}{9} \sin n\pi x \, dx + 2 \int_{0.9}^1 (5 - 5x) \sin n\pi x \, dx \\
 &= -\frac{10}{9n\pi} \left[x \cos n\pi x \Big|_0^{0.9} - \int_0^{0.9} \cos n\pi x \, dx \right] - \frac{10}{n\pi} \left[(1-x) \cos n\pi x \Big|_{0.9}^1 - \int_{0.9}^1 \cos n\pi x \, dx \right] \\
 &= -\frac{\cos 0.9n\pi}{n\pi} + \frac{10}{9n^2\pi^2} \sin n\pi x \Big|_0^{0.9} + \frac{\cos 0.9n\pi}{n\pi} - \frac{10}{n^2\pi^2} \sin n\pi x \Big|_{0.9}^1 = \frac{100}{9n^2\pi^2} \sin 0.9n\pi.
 \end{aligned}$$

(b) See Figure 91.

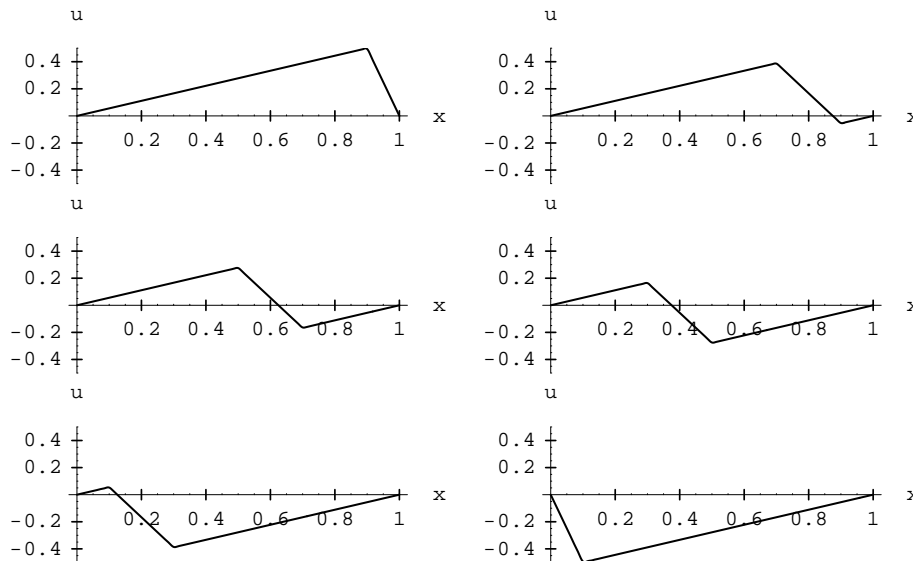

Figure 91: Exercise 8.4.9

(c) The total amplitude $\int_0^1 u(x,0) \, dx$ is the same for both problems. Both problems have a triangular initial profile. The difference is that the initial profile for Model Problem 8.4 is symmetric about $x = 0.5$, but the initial profile for Exercise 9 is skewed to the right. The waves for Model Problem 8.4 continue to be symmetric, while the waves for Exercise 9 continue to be skewed. For Exercise 9, the peak of the wave gradually moves from 0.9 to 0.1 and diminishes in magnitude. The negative displacement begins quickly near $x = 1$ and spreads to the left also.

11. The amplitude functions were found in Exercise 8.3.4 to be

$$g_n(t) = \frac{L}{n\pi c} \sin \frac{n\pi ct}{L}.$$

The initial condition then requires

$$\psi(x) = \sum_{n=1}^{\infty} b_n g'_n(0) \sin \frac{n\pi x}{L} = \sum_{n=1}^{\infty} b_n \sin \frac{n\pi x}{L}.$$

This is the same equation we solved to determine the Fourier coefficients before, with the result

$$b_n = \frac{2}{L} \int_0^L \psi(x) \sin \frac{n\pi x}{L} \, dx.$$

Chapter 8: Vibrating Strings

One can also use

$$g_n(t) = \sin \frac{n\pi ct}{L}, \quad b_n = \frac{2}{n\pi c} \int_0^L \psi(x) \sin \frac{n\pi x}{L} dx.$$

13. (a) The solution is

$$u(x, t) = \sum_{n=1}^{\infty} b_n \sin n\pi t \sin n\pi x$$

where, by Exercises 1 and 2,

$$b_n = \frac{1}{n\pi} \left\{ \frac{2}{n\pi} [p(0) - (-1)^n p(1)] - \frac{2}{n^3 \pi^3} [p''(0) - (-1)^n p''(1)] \right\} = -\frac{4[1 + 2(-1)^n]}{n^4 \pi^4}.$$

(b) See Figure 92.

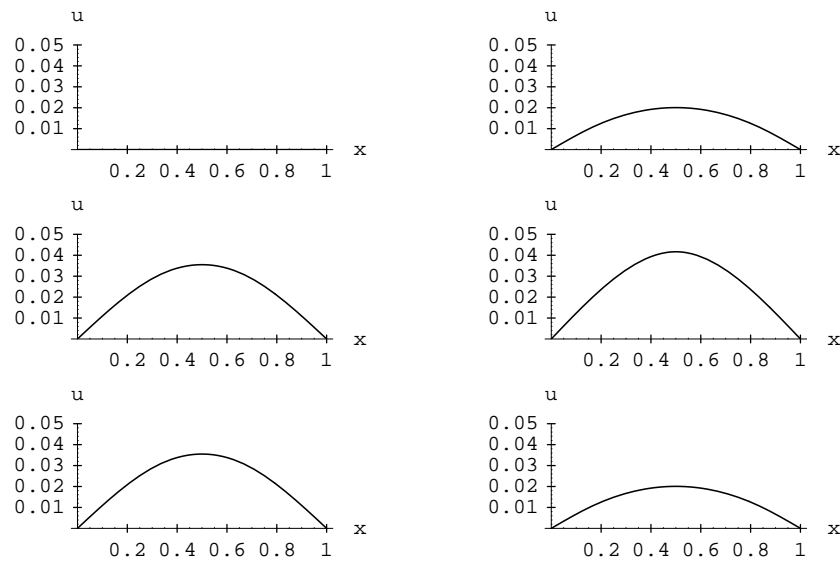

Figure 92: Exercise 8.4.13

Section 8.5

1. F is even, so the sine coefficients are 0 and the cosine coefficients are

$$a_n = \frac{2}{\pi} \int_0^{\pi} x \cos nx \, dx.$$

Using the notation and formulas of Exercises 8.4.1 and 8.4.2, with $p(x) = x$, we have

$$a_n = -\frac{1}{n} b'_n = -\frac{2}{n^2 \pi} [p'(0) - (-1)^n p'(\pi)] = -\frac{2[1 - (-1)^n]}{n^2 \pi}$$

The average value is $\pi/2$ so

$$f_s(x) = \frac{\pi}{2} - \frac{2}{\pi} \sum_{n=1}^{\infty} \frac{[1 - (-1)^n]}{n^2} \cos n\pi x.$$

See Figure 93.

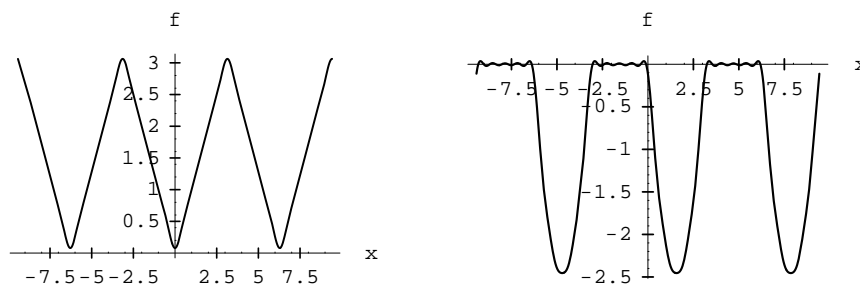

Figure 93: Exercise 8.5.1

3. F is even, so the sine coefficients are 0 and the cosine coefficients are

$$a_n = 2 \int_0^1 (1 - x^2) \cos nx \, dx.$$

Using the notation and formulas of Exercises 8.4.1 and 8.4.2, with $p(x) = 1 - x^2$, we have

$$a_n = -\frac{1}{n\pi} b'_n = -\frac{2}{n^2\pi^2} [p'(0) - (-1)^n p'(1)] = -\frac{4(-1)^n}{n^2\pi^2}.$$

The average value is $2/3$, so

$$f_s(x) = \frac{2}{3} - \frac{4}{\pi^2} \sum_{n=1}^{\infty} \frac{(-1)^n}{n^2} \cos n\pi x.$$

See Figure 94.

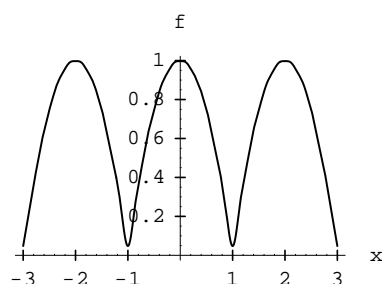

Figure 94: Exercise 8.5.3

5. See Figure 95. Theorem 8.5.2 identifies properties of the series sum f_s , not the individual partial sums in the sequence that converges to f_s . Adding more terms to the partial sum makes the oscillation faster and decreases the amplitude of the error at points well inside of the oscillatory region, but does not decrease the overshoot amplitude. However, the near-vertical line at the point of discontinuity of f becomes more vertical as $n \rightarrow \infty$. Any fixed value of x where f is continuous is eventually some distance into the oscillatory region. Thus, as $n \rightarrow \infty$, points where f is continuous do show convergence to f_s , albeit very slowly. The

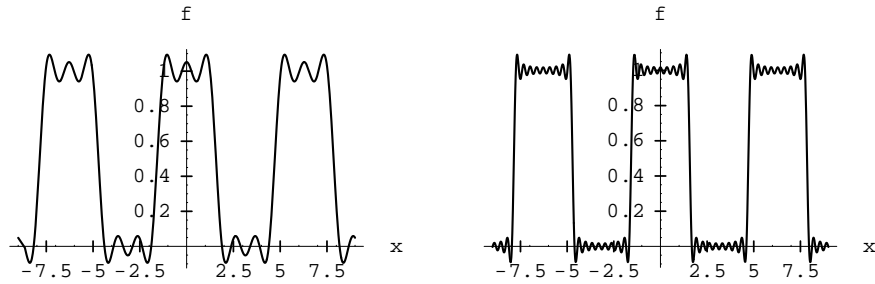

Figure 95: Exercise 8.5.5

point of discontinuity is always at the midpoint of the near-vertical line; hence, the value of the partial sum at that point does appear to be approaching the average of the limiting values.

7. (a)

$$u(x, t) = \sum_{n=1}^{\infty} b_n \cos n\pi t \sin n\pi x,$$

where

$$b_n = 2 \int_0^1 \sin n\pi x \, dx = \frac{2[1 - (-1)^n]}{n\pi}.$$

(b) The solution over the first half of the given time interval shows the function value 1 gradually being “replaced” by the value 0 from the endpoints in. For the second half of the interval, the solution shows the value 0 being replaced by the value -1 from the center to the outside. The actual solution should consist of horizontal lines; however, any visualization using Fourier series shows oscillations and overshoots because of the Gibbs phenomenon. See Figure 96.

9. (a) By Exercise 8.4.11,

$$u(x, t) = \sum_{n=1}^{\infty} b_n \sin n\pi t \sin n\pi x,$$

where

$$b_n = \frac{2}{n\pi} \int_0^1 \sin n\pi x \, dx = \frac{2[1 - (-1)^n]}{n^2\pi^2}.$$

(b) See Figure 97.

11. Substituting $u(r, \theta) = g(r)h(\theta)$ into the differential equation gives us

$$\frac{r^2 g'' + r g'}{g} = \frac{-h''}{h} = \sigma$$

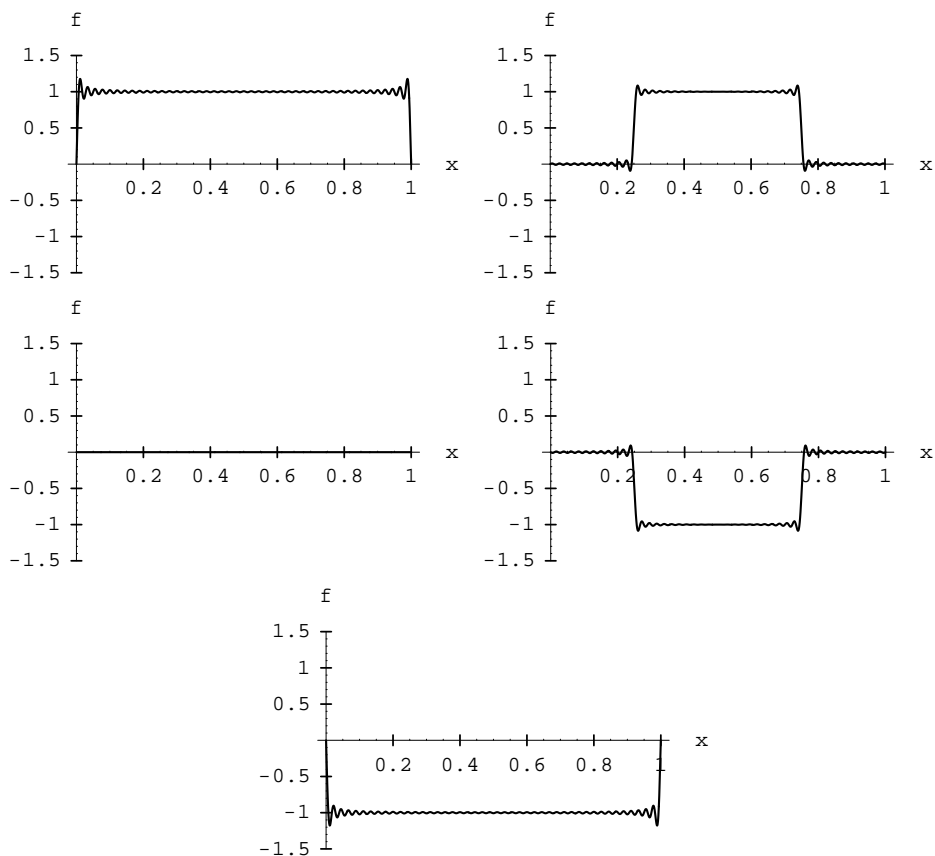

Figure 96: Exercise 8.5.7

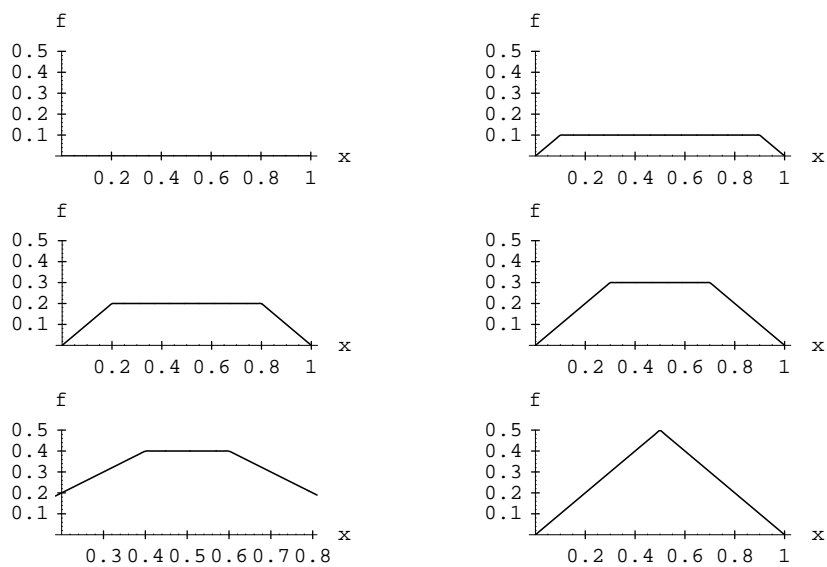

Figure 97: Exercise 8.5.9

for some constant σ . The problem for g is

$$r^2 g'' + r g' - \sigma g = 0, \quad |g(0)| < \infty,$$

Chapter 8: Vibrating Strings

and the problem for h is

$$h'' + \sigma h = 0, \quad h(-\pi) = h(\pi), \quad h'(-\pi) = h'(\pi).$$

The h problem is fully specified, so we solve it first. If $\sigma < 0$, then there are no nontrivial solutions. If $\sigma = 0$, then there is a solution $h = a_0$, where a_0 is a constant, and the g problem is also solved by a constant. If $\sigma = \lambda^2$ with $\lambda > 0$, then the differential equation has a two-parameter family of solutions

$$h = a \cos \lambda \theta + b \sin \lambda \theta.$$

These solutions satisfy both boundary conditions if and only if λ is a positive integer. Thus, we have the family

$$h_n = a_n \cos n\theta + b_n \sin n\theta,$$

and the corresponding g problem is

$$r^2 g_n'' + r g_n' - n^2 g = 0, \quad |g(0)| < \infty.$$

Substituting $g = r^m$ yields the algebraic equation $m^2 = n^2$, so $m = \pm n$. The boundary condition forces $m = n$. Hence, we have a family

$$u = a_0 + \sum_{n=1}^{\infty} r^n (a_n \cos n\theta + b_n \sin n\theta)$$

of functions that solves the homogeneous parts of the problem. The remaining boundary condition requires

$$a_0 + \sum_{n=1}^{\infty} (a_n \cos n\theta + b_n \sin n\theta) = f(\theta).$$

This is the standard Fourier series problem, so the coefficients are given by

$$a_0 = \bar{f} = \frac{1}{2\pi} \int_{-\pi}^{\pi} f(\theta) d\theta, \quad a_n = \frac{1}{\pi} \int_{-\pi}^{\pi} f(\theta) \cos n\theta d\theta, \quad b_n = \frac{1}{\pi} \int_{-\pi}^{\pi} f(\theta) \sin n\theta d\theta.$$

Section A.1

1. To find the integrating factor, we solve $(\mu y)' = \mu y' - 4\mu y$. Thus, $\mu' = -4\mu$. An integrating factor is $\mu = e^{-4t}$. The differential equation becomes $(e^{-4t}y)' = te^{-3t}$. Integrating both sides and solving for y yields

$$y = -\left(\frac{1}{3}t + \frac{1}{9}\right)e^{-t} + ce^{4t}.$$

3. To find the integrating factor, we solve $(\mu y)' = \mu y' - 4\mu y$. Thus, $\mu' = -4\mu$. An integrating factor is $\mu = e^{-4t}$. The differential equation becomes $(e^{-4t}y)' = t$. Integrating both sides and solving for y yields

$$y = \frac{1}{2}t^2e^{4t} + ce^{4t}.$$

5. To find the integrating factor, we solve $(\mu y)' = \mu y' - 3\mu y$. Thus, $\mu' = -3\mu$. An integrating factor is $\mu = e^{-3t}$. The differential equation becomes $(e^{-3t}y)' = e^{-3t}\cos t$. Integrating both sides and solving for y yields

$$y = \frac{1}{10}\sin t - \frac{3}{10}\cos t + ce^{3t}.$$

7. To find the integrating factor, we solve $(\mu y)' = \mu y' + \mu y$. Thus, $\mu' = \mu$. An integrating factor is $\mu = e^t$. The differential equation becomes $(e^t y)' = e^t/(1 + e^t)$. Integrating both sides and solving for y yields

$$y = e^{-t}\ln(1 + e^t) + ce^{-t}.$$

9. To find the integrating factor, we solve $(\mu y)' = \mu y' + \mu t y$. Thus, $\mu' = \mu t$. An integrating factor is $\mu = e^{t^2/2}$. The differential equation becomes $(e^{t^2/2}y)' = 2te^{t^2/2}$. Integrating both sides and solving for y yields

$$y = 2 + ce^{-t^2/2}.$$

11. To find the integrating factor, we solve $(\mu y)' = \mu y' + 2\mu t y$. Thus, $\mu' = 2\mu t$. An integrating factor is $\mu = e^{t^2}$. The differential equation becomes $(e^{t^2}y)' = \cos t$. Integrating both sides and solving for y yields

$$y = e^{-t^2}\sin t + ce^{-t^2}.$$

13. To find the integrating factor, we solve $(\mu y)' = \mu y' + \mu(1 + 1/t)y$. Thus, $\mu' = \mu(1 + 1/t)$. An integrating factor is $\mu = te^t$. The differential equation becomes $(te^t y)' = e^t$. Integrating both sides and solving for y yields

$$y = \frac{1}{t}(1 + ce^{-t}).$$

15. To find the integrating factor, we solve $(\mu y)' = \mu y' - \mu(\tan t)y$. Thus, $\mu' = -\mu \tan t$. An integrating factor is $\mu = \cos t$. The differential equation becomes $(y \cos t)' = \cos t$. Integrating both sides and solving for y yields

$$y = \tan t + c \sec t.$$

17. To find the integrating factor, we solve $(\mu y)' = \mu y' - 2\mu y/t$. Thus, $\mu' = -2\mu/t$. An integrating factor is $\mu = 1/t^2$. The differential equation becomes $(y/t^2)' = 6t^2$. Integrating both sides and solving for y yields $y = 2t^5 + ct^2$. Using the initial conditions gives us

$$y = 2t^5 - 2t^2, \quad -\infty < t < \infty.$$

Chapter A: Some Additional Topics

19. To find the integrating factor, we solve $(\mu y)' = \mu y' - 2\mu ty/(1+t^2)$. Thus, $\mu' = -2\mu t/(1+t^2)$. An integrating factor is $\mu = 1/(1+t^2)$. The differential equation becomes $[y/(1+t^2)]' = 1/(1+t^2)$. Integrating both sides and solving for y yields $y = (1+t^2) \arctan t + c(1+t^2)$. Using the initial conditions gives us

$$y = (1+t^2) \arctan t, \quad -\infty < t < \infty.$$

21. To find the integrating factor, we solve $(\mu y)' = \mu y' + 2\mu \tan t y$. Thus, $\mu' = 2\mu \tan t$. An integrating factor is $\mu = \sec^2 t$. The differential equation becomes $(y \sec^2 t)' = \sec^2 t$. Integrating both sides and solving for y yields $y = \sin t \cos t + c \cos^2 t$. Using the initial conditions gives us

$$y = \sin t \cos t + \cos^2 t, \quad -\infty < t < \infty.$$

23. To find the integrating factor, we solve $(\mu y)' = \mu y' - 8\mu ty$. Thus, $\mu' = -8\mu t$. An integrating factor is $\mu = e^{-4t^2}$. The differential equation becomes $(e^{-4t^2} y)' = e^{-4t^2}$. Integrating both sides yields $e^{-4t^2} y = \int_0^t e^{-4s^2} ds + c = \frac{1}{2} \int_0^{2t} e^{-u^2} du + c = \frac{\sqrt{\pi}}{4} \operatorname{erf} 2t + c$. Using the initial conditions gives us

$$y = e^{4t^2} \left(\frac{\sqrt{\pi}}{4} \operatorname{erf} 2t + 1 \right), \quad -\infty < t < \infty.$$

25. To find the integrating factor, we solve $(\mu y)' = \mu y' + m\mu/ty$. Thus, $\mu'/\mu = m/t$ and an integrating factor is t^m . The differential equation is then $(t^m y)' = kt^{n+m-1}$.

- (a) Integrating both sides of $(t^m y)' = kt^{-1}$ yields $t^m y = k \ln |t| + c$. Thus,

$$y = kt^{-m} \ln |t| + ct^{-m}.$$

- (b) Integrating both sides of $(t^m y)' = kt^{n+m-1}$ yields $t^m y = kt^{n+m}/(n+m) + c$. Thus,

$$y = \frac{k}{n+m} t^n + ct^{-m}.$$

- (c) If we had $c = 0$, then the solution $kt^n/(n+m)$ would be defined for all t . The theorem in question guarantees the existence of a solution over some interval but does not prohibit the solution from existing over a larger interval.

- (d) If both m and n are negative, the term $kt^n/(n+m)$ is undefined at $t = 0$. No matter what c is chosen, this prevents the solution from being defined at $t = 0$.

27. (a) As in Exercise 15, an integrating factor is $\mu = \cos t$. The differential equation becomes $(y \cos t)' = \sin t \cos t$. Integrating both sides yields $y \cos t = \frac{1}{2} \sin^2 t + c$, and the initial condition requires $c = k$. Thus, the solution is

$$y = \frac{1}{2} \sin t \tan t + k \sec t, \quad -\frac{\pi}{2} < t < \frac{\pi}{2}.$$

- (b) Setting $y = 0$, we find that the solution vanishes at any time for which $k = -\frac{1}{2} \sin^2 t$. Given the range of possible sine values on the interval of validity, this condition requires $-\frac{1}{2} < k \leq 0$.

- (c) The solution is an even function; therefore, $t = 0$ is a critical point. Taking a derivative of the original equation, we have

$$y'' - y' \tan t - y \sec^2 t = \cos t,$$

and so $y''(0) = \cos 0 + y'(0) \tan 0 + y(0) \sec^2 0 = 1 + k$. The origin is a local minimum for $k > -1$. For $k < -1$, the origin is a local maximum. Also, we have

$$\begin{aligned} y' &= \sin t - y \tan t = \sin t + \frac{1}{2} \sin t \tan^2 t + k \tan t \sec t \\ &= \frac{1}{2} \tan t \sec t (2 \cos^2 t + \sin^2 t + 2k) = \frac{1}{2} \tan t \sec t (\cos^2 t + 1 + 2k). \end{aligned}$$

Thus, there can be no other critical points with $k < -1$. Hence, the origin is the global maximum whenever $k < -1$ and not whenever $k > -1$. The case $k = -1$ must be treated separately. From the calculation for y' , we know that there are no critical points other than the origin. We also have $y(0) = -1$, $y'(0) = 0$, and $y''(0) = 0$. Differentiating further, we have

$$y''' = y'' \tan t + 2y' \sec^2 t + 2y \tan t \sec^2 t - \sin t$$

and

$$y'''' = y''' \tan t + 3y'' \sec^2 t + 6y' \tan t \sec^2 t + 2y(\sec^4 t + 2 \tan^2 t \sec^2 t) - \cos t;$$

hence, $y'''(0) = 0$ and $y''''(0) = -3$. We therefore have the Taylor approximation $y \approx -1 - 3t^2/4!$ near $t = 0$, confirming that the origin is also a maximum for the case $k = -1$.

Section A.2

1.

$$y_1(t) = \int_0^t f(s, 0) ds = \int_0^t 1 ds = t.$$

$$y_2(t) = \int_0^t f(s, s) ds = \int_0^t 1 - s^2 ds = t - \frac{t^3}{3}.$$

$$y_3(t) = \int_0^t f\left(s, s - \frac{s^3}{3}\right) ds = \int_0^t 1 - s\left(s - \frac{s^3}{3}\right) ds = t - \frac{t^3}{3} + \frac{t^5}{15}.$$

See Figure 98.

3.

$$y_1(t) = \int_0^t f(s, 0) ds = \int_0^t s^2 ds = \frac{t^3}{3}.$$

$$y_2(t) = \int_0^t f\left(s, \frac{s^3}{3}\right) ds = \int_0^t s^2 + \frac{s^6}{9} ds = \frac{t^3}{3} + \frac{t^7}{63}.$$

$$y_3(t) = \int_0^t f\left(s, \frac{s^3}{3} + \frac{s^7}{63}\right) ds = \int_0^t s^2 + \frac{s^6}{9} + \frac{2s^{10}}{189} + \frac{s^{14}}{(63)^2} ds = \frac{t^3}{3} + \frac{t^7}{63} + \frac{2t^{11}}{(189)(11)} + \frac{t^{15}}{(63)^2 15}.$$

See Figure 99.

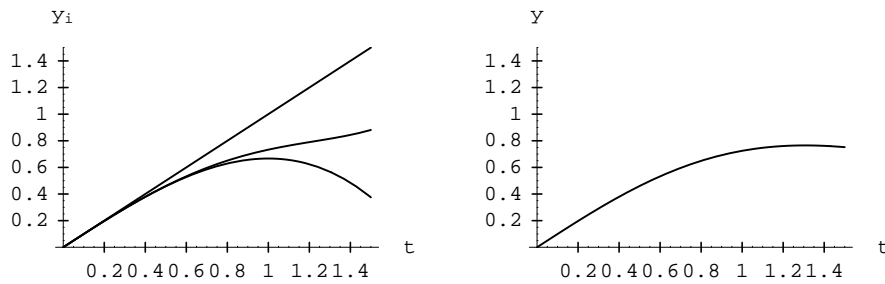

Figure 98: Exercise A.2.1

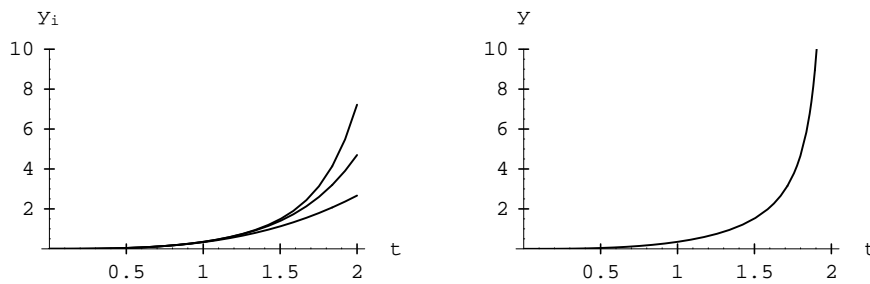

Figure 99: Exercise A.2.3

9. (a) Since $\frac{dy}{dt} = \frac{2t - y}{1 - y}$, y must be an increasing function if $y < 2t$ and $y < 1$, and decreasing if $y > 2t$ and $y < 1$. Thus the solution for $t < 1/2$ is increasing, but it can never go above the line $y = 2t$.
- (b) Since $y < 2t$ and $y < b < 1$, it follows that $f > 0$. Now,

$$\frac{\partial f}{\partial t} = \frac{2}{1 - y} > 0, \quad \frac{\partial f}{\partial y} = \frac{2t - 1}{(1 - y)^2}.$$

The first partial derivative means that the maximum must occur with $t = a$. Then $\partial f / \partial y(a, y) = (2a - 1) / (1 - y)^2 > 0$, so the maximum must occur at (a, b) .

- (c) As long as the solution curve remains in D , its slope satisfies $y' \leq f(a, b) = (2a - b) / (1 - b)$.
- (d) The line passing through the origin and having slope $(2a - b) / (1 - b)$ is

$$y_m = \frac{2a - b}{1 - b}t.$$

This line passes through the point (a, b) if $b(1 - b) = a(2a - b)$.

- (e) Suppose there exists a pair of values a and b that satisfies the requirement of part (d). Then $y \leq y_m < 2t$ and $y \leq y_m \leq b$ for all $t \leq a$. Hence, the graph of y lies in the region D defined by that choice of a and b . In particular, for any given a , there needs to be only one acceptable choice of b to guarantee existence of the solution all the way to $t = a$.

- (f) The equation $b(1 - b) = a(2a - b)$ defines a smooth curve in the ab plane that passes through the points $(0, 0)$ and $(0, 1)$. The curve must move into the first quadrant of the ab plane and then back to the b axis; hence, we can think of the curve as the graph of a function $a(b)$. Each value of a that can be achieved for some b represents a time at which the solution must exist. Hence, the solution is guaranteed to exist for any a less than the maximum of the function $a(b)$ defined implicitly by $b(1 - b) = a(2a - b)$. By implicit differentiation, $1 - 2b = a'(2a - b) + a(2a' - 1)$; thus,

$$a' = \frac{1 + a - 2b}{4a - b}.$$

At the desired maximum, $a' = 0$; hence, $2b = 1 + a$. Substituting this relation into the equation of the curve yields the quadratic equation $7a^2 - 2a - 1 = 0$. This equation has one positive solution, $a = (1 + 2\sqrt{2})/7 \approx 0.55$, so the solution is guaranteed to exist up to that time. Note that this is quite a bit less than the actual interval of existence, which by Figure A.2.2 in the text clearly extends beyond $t = 0.8$. With more work, a better estimate could perhaps be achieved. The point of the exercise, in part, is that it is not worth the effort of making careful estimates of intervals of existence by theoretical arguments.

Section A.3

1. (a)

$$\max \left| \frac{\partial f}{\partial y} \right| = \max \left| \frac{-8e^{-t}}{(3+y)^2} \right| \leq \frac{8}{9} = K$$

$$\max |f_t + ff_y| = \max \left| \frac{-8}{3+y} - \frac{(8e^{-t})^2}{(3+y)^3} \right| \leq \frac{136}{27} = M.$$

- (b) The upper bounds for the error at 0.2, 0.4, 0.6, 0.8, and 1 are respectively 0.0137813, 0.0302439, 0.0499095, 0.0734012, and 0.101463.
- (c) The actual errors are all significantly smaller. The ratio of the errors at each t are respectively 0.653, 0.4629, 0.3607, 0.2725, and 0.2070. Note that the ratio of actual error to the upper bound on the error is going down. Since $\frac{\partial f}{\partial y} = -8e^{-t}(3+y)^2 < 0$, the problem is well conditioned and this is the behavior we expect.

3. (a) We have

$$y(t_1) = y(t_0) + hy'(t_0) + \frac{h^2}{2}y''(t_0) + \frac{h^3}{6}y'''(\tau_1),$$

$$y(t_0) = y(t_1) - hy'(t_1) + \frac{h^2}{2}y''(t_1) - \frac{h^3}{6}y'''(\tau_2),$$

where $h = t_1 - t_0$ and τ_1 and τ_2 are unknowns points between t_0 and t_1 . Solving the second equation for $y(t_1)$ gives us

$$y(t_1) = y(t_0) + hy'(t_1) - \frac{h^2}{2}y''(t_1) + \frac{h^3}{6}y'''(\tau_2).$$

Averaging the formulas for $y(t_1)$ yields

$$y(t_1) = y(t_0) + \frac{h}{2} [y'(t_0) + y'(t_1)] - \frac{h^2}{4} [y''(t_1) - y''(t_0)] + \frac{h^3}{12} [y'''(\tau_1) + y'''(\tau_2)].$$

(b)

$$y(t_1) = y_0 + \frac{h}{2} [f(t_0, y_0) + f(t_1, y(t_1))] - \frac{h^2}{4} [y''(t_1) - y''(t_0)] + \frac{h^3}{12} [y'''(\tau_1) + y'''(\tau_2)].$$

(c) The trapezoidal rule says $y_1 = y_0 + \frac{1}{2}h[f(t_0, y_0) + f(t_1, y_1)]$. Subtracting the result of part (b) from the trapezoidal rule yields

$$y_1 - y(t_1) = \frac{h}{2} [f(t_1, y_1) - f(t_1, y(t_1))] + \frac{h^2}{4} [y''(t_1) - y''(t_0)] - \frac{h^3}{12} [y'''(\tau_1) + y'''(\tau_2)].$$

(d) Using Taylor's Theorem, we have $f(t_1, y(t_1)) = f(t_1, y_1) + [y(t_1) - y_1]f_y(t_1, \eta)$ for some η between y_1 and $y(t_1)$. Also, $y''(t_1) = y''(t_0) + hy'''(\tau_3)$ for some τ_3 between t_0 and t_1 . Hence,

$$f(t_1, y_1) - f(t_1, y(t_1)) = E_1 f_y(t_1, \eta), \quad y''(t_1) - y''(t_0) = hy'''(\tau_3).$$

Substituting these results into that from part (c) yields

$$E_1 = \frac{h}{2} E_1 f_y(t_1, \eta) + \frac{h^3}{4} y'''(\tau_3) - \frac{h^3}{12} [y'''(\tau_1) + y'''(\tau_2)],$$

from which we obtain

$$E_1 = \frac{3y'''(\tau_3) - y'''(\tau_1) - y'''(\tau_2)}{6[2 - hf_y(t_1, \eta)]} h^3.$$

5. (a) We have $|E_1| \leq \frac{Mh^2}{2}$. We also have

$$|E_2| \leq \frac{Mh^2}{2} [(1 + Kh) + 1], \quad |E_3| \leq \frac{Mh^2}{2} [(1 + Kh)^2 + (1 + Kh) + 1].$$

In general,

$$|E_n| \leq \frac{Mh^2}{2} \sum_{j=0}^{n-1} (1 + Kh)^j.$$

(b) Given $S = \sum_{j=0}^{n-1} (1 + Kh)^j$, $(1 + Kh)S = \sum_{j=0}^{n-1} (1 + Kh)^{j+1} = \sum_{j=1}^n (1 + Kh)^j$. Thus, $KhS = (1 + Kh)^n - 1$ and

$$|E_n| \leq \frac{Mh^2}{2} [(1 + Kh)^n - 1].$$

(c)

$$e^{Kh} = 1 + Kh + \frac{(Kh)^2}{2} + \dots \geq 1 + Kh.$$

(d)

$$|E_n| \leq \frac{Mh}{2K} (e^{Khn} - 1) = \frac{Mh}{2K} (e^{Ktn} - 1).$$

7. (a) The initial-value problem is $\frac{dT}{dt} = k(T - 68)$, $T(6) = 77$, $T(7) = 74$. The solution is $T = Ce^{kt} + 68$. The additional conditions imply that $C = 102.51$ and $k = -0.4054$. Thus $T(t) = 98.6$ means $t = 2.98$, which is 2:59 to the nearest minute.

- (b) If we change the equation to $T(t) = 100$, we find $t = 2.87$, which is 2:52 to the nearest minute.
- (c) If we change the measurements as indicated, we obtain $T = 71.948e^{-0.3502t} + 68$. Solving $T(t) = 98.6$ then yields $t = 2.44$, which is 2:24 to the nearest minute and is more than 30 minutes earlier than we estimated in part (a).
- (d) Since $\frac{\partial f}{\partial y} < 0$ the *differential equation* is well conditioned. However, the problem prescribes final data and requires calculation of initial data; hence, the *problem* is ill-conditioned.
- (e) They must assume that they know the value of k .

Section A.4

From the series $y = \sum_{n=0}^{\infty} a_n x^n$, we have

$$x^p y = \sum_{m=p}^{\infty} a_{m-p} x^m,$$

$$x^p y' = \sum_{m=p}^{\infty} (m+1-p) a_{m+1-p} x^m = \sum_{m=p-1}^{\infty} (m+1-p) a_{m+1-p} x^m,$$

$$x^p y'' = \sum_{m=p}^{\infty} (m+1-p)(m+2-p) a_{m+2-p} x^m = \sum_{m=p-2}^{\infty} (m+1-p)(m+2-p) a_{m+2-p} x^m.$$

These formulas will be used in the exercises of this section.

1. Substituting the formulas for xy , xy' , and y'' into the differential equation yields

$$4a_2 + \sum_{m=1}^{\infty} [2(m+1)(m+2)a_{m+2} - ma_m + a_{m-1}]x^m = 0.$$

This leads to $a_2 = 0$ and the recurrence relation

$$a_n = \frac{(n-2)a_{n-2} - a_{n-3}}{2(n-1)n}, \quad n \geq 3.$$

Thus, $a_0 = -1$, $a_1 = 2$, $a_2 = 0$, $a_3 = \frac{1}{4}$, $a_4 = -\frac{1}{12}$, $a_5 = \frac{3}{160}$, $a_6 = -\frac{7}{720}$.

3. Substituting the formulas for y , y'' , and xy'' into the differential equation yields

$$\sum_{m=0}^{\infty} [(m+1)(m+2)a_{m+2} + (m+1)ma_{m+1} - 3a_m]x^m = 0.$$

This leads to the recurrence relation

$$a_n = \frac{3a_{n-2} - (n-1)(n-2)a_{n-1}}{n(n-1)}, \quad n \geq 2.$$

Thus, $a_0 = 2$, $a_1 = 1$, $a_2 = 3$, $a_3 = -\frac{3}{2}$, $a_4 = \frac{3}{2}$, $a_5 = -\frac{9}{8}$.

Chapter A: Some Additional Topics

5. Substituting the formulas for y , xy' , y'' , and x^2y'' into the differential equation yields

$$\sum_{m=0}^{\infty} [(m+1)(m+2)a_{m+2} + m(m-1)a_m + 2ma_m - 2a_m]x^m = 0.$$

This leads to the recurrence relation

$$a_n = -\frac{a_{n-2}(n-3)}{n-1}, \quad n \geq 2.$$

With $a_0 = 1$ and $a_1 = 0$, we obtain

$$y_1 = 1 + x^2 - \frac{1}{3}x^4 + \frac{1}{5}x^6 + \cdots = 1 + x \arctan x.$$

With $a_0 = 0$ and $a_1 = 1$, we obtain

$$y_2 = x.$$

7. Substituting the formulas for y , xy' , and y'' into the differential equation yields

$$\sum_{m=0}^{\infty} [(m+1)(m+2)a_{m+2} - ma_m + a_m]x^m = 0.$$

This leads to the recurrence relation

$$a_n = \frac{(n-3)}{n(n-1)}a_{n-2}, \quad n \geq 2.$$

With $a_0 = 1$ and $a_1 = 0$, we obtain

$$y_1 = 1 - \frac{1}{2}x^2 - \frac{1}{24}x^4 - \frac{1}{240}x^6 - \cdots.$$

With $a_0 = 0$ and $a_1 = 1$, we obtain

$$y_2 = x.$$

9. Substituting the formulas provided for y , x^2y , and y'' into the differential equation yields

$$\sum_{m=2}^{\infty} \left[(m+1)(m+2)a_{m+2} + \left(\nu + \frac{1}{2} \right) a_m - \frac{1}{4}a_{m-2} \right] x^m = 0, \quad a_{-1} = a_{-2} = 0.$$

This leads to the recurrence relation

$$a_n = \frac{1}{4n(n-1)}a_{n-4} - \frac{(\nu + \frac{1}{2})}{n(n-1)}a_{n-2}.$$

The general solution is

$$\begin{aligned} y &= c_1 \left[1 - \frac{\nu + 1/2}{2}x^2 + \left(\frac{1}{48} + \frac{(\nu + 1/2)^2}{24} \right) x^4 + \cdots \right] \\ &+ c_2 \left[x - \frac{\nu + 1/2}{6}x^3 + \left(\frac{1}{80} + \frac{(\nu + 1/2)^2}{120} \right) x^5 + \cdots \right] \end{aligned}$$

11. (a) Substituting the formulas provided for y , y' , and xy' into the differential equation yields

$$\sum_{k=0}^{\infty} [(k+1)a_{k+1} + ka_k - ma_k]x^k = 0,$$

where we have used k as the dummy index rather than m . This leads to the recurrence relation

$$a_n = \frac{(m-n+1)}{n}a_{n-1}.$$

Thus, $a_0 = 1$, $a_1 = m$, $a_2 = m(m-1)/2$, $a_3 = m(m-1)(m-2)/6$, and $a_n = m(m-1)(m-2)\cdots(m-(n-1))/n!$. Hence,

$$y = \sum_{n=0}^{\infty} \frac{m(m-1)(m-2)\cdots[m-(n-1)]}{n!}x^n = \sum_{n=0}^{\infty} \frac{m!}{n!(n-m)!}x^n = \sum_{n=0}^{\infty} \binom{m}{n}x^n.$$

- (b) By separation of variables, we have

$$\int \frac{dy}{y} = \int \frac{m dx}{1+x},$$

or $y = C(1+x)^m$. The initial condition requires $C = 1$; hence, $y = (1+x)^m$.

- (c) Combining the results of parts (a) and (b) yields

$$(1+x)^m = \sum_{n=0}^{\infty} \binom{m}{n}x^n.$$

13. Using Theorem A.4.2, we find $\alpha^2 - \nu^2 = 0$ or $\alpha = \pm\nu$. Then $\alpha_1 - \alpha_2 = 2\nu$ is not an integer if ν is not an integer multiple of $\frac{1}{2}$. Thus there are always two linearly independent solutions if ν is not an integer multiple of $\frac{1}{2}$.

15. (a) We find that the α in Theorem A.4.2 is $\alpha = \pm 1/2$. Letting $y = x^\alpha z$ gives us the equation

$$x^2 z'' + (2\alpha + 1)xz' + x^2 z = 0.$$

For the case $\alpha = -\frac{1}{2}$, we can solve the equation immediately by writing it as $z'' + z = 0$. Since the calculations that led to this equation required the assumption $z_0 = 1$, we may choose $z = \cos x$ for the solution of this case. For $\alpha = \frac{1}{2}$, we substitute for $x^2 z$, xz' , and $x^2 z''$ in the differential equation and get

$$2a_1 + \sum_{m=2}^{\infty} [m(m-1)a_m + 2ma_m + a_{m-2}]x^m = 0.$$

This leads to the results

$$a_0 = 1, \quad a_1 = 0, \quad a_n = \frac{-a_{n-2}}{n(n+1)}.$$

The corresponding solution is

$$z = 1 - \frac{1}{3!}x^2 + \frac{1}{5!}x^4 + \cdots = \frac{1}{x} \sin x.$$

Chapter A: Some Additional Topics

(b) Theorem A.4.2 guarantees at least one power series solution in this case. It does not prohibit the presence of a second.

(c) The solutions are $x^{-1/2} \cos x$ and $x^{-1/2} \sin x$

17. The indicial equation has roots $\alpha = 1$ and $\alpha = -\frac{1}{2}$, each of which corresponds to a solution. From the original equation, we have

$$-a_0 + \sum_{m=1}^{\infty} [2m(m-1)a_m + ma_m - a_m - a_{m-1}]x^m = 0.$$

This leads to the results $a_0 = 0$ and $a_1 = 1$ (as guaranteed by Theorem A.4.2) and the recurrence relation

$$a_n = \frac{a_{n-1}}{(2n+1)(n-1)}, \quad n \geq 2,$$

from which we obtain a solution

$$y_1 = x + \frac{x^2}{1 \cdot 5} + \frac{x^3}{1 \cdot 5 \cdot 2 \cdot 7} + \frac{x^4}{1 \cdot 5 \cdot 2 \cdot 7 \cdot 3 \cdot 9} + \cdots$$

The substitution $y = x^{-1/2}z$ yields the equation

$$2xz'' - z' - z = 0,$$

the series equation

$$\sum_{m=0}^{\infty} [2m(m+1)a_{m+1} - (m+1)a_{m+1} - a_m]x^m = 0,$$

the recurrence relation

$$a_n = \frac{a_{n-1}}{n(2n-3)},$$

and the solution

$$y_2 = x^{-1/2} \left(1 - x - \frac{x^2}{2} - \frac{x^3}{2 \cdot 3 \cdot 3} - \cdots \right).$$

19. (a) Making the suggested substitution gives us

$$-\alpha a_0 x^{-1} + \sum_{n=0}^{\infty} [(\alpha+n)(\alpha+n-1)a_n + 3(\alpha+n)a_n + a_n - (\alpha+n+1)a_{n+1}]x^n = 0.$$

(b) $\alpha = 0$ is necessary to remove the first term.

(c) We have

$$\sum_{n=0}^{\infty} [n(n-1)a_n + 3na_n + a_n - (n+1)a_{n+1}]x^n = 0,$$

which leads to the recurrence relation $a_n = na_{n-1}$.

(d) Since $a_0 = c$, $a_1 = c$, $a_2 = 2c$, and in general $a_n = n!c$. Thus $y = c \sum_{n=0}^{\infty} n!x^n$.

(e) This series does not converge for any value of x .

(f) The differential equation is not of a form covered by the hypothesis of Theorem A.4.2, so it does not contradict the theorem.

- (g) Assume $y = x^\alpha z$, with α to be chosen so that $z_0 = 1$. Substituting into the differential equation gives us

$$x^3 z'' + (2\alpha + 3)x^2 z' - xz' + (\alpha + 1)^2 xz - \alpha z = 0.$$

Looking for a series solution leads us to

$$\alpha a_0 + \sum_{m=1}^{\infty} [(m-1)(m-2)a_{m-1} + (2\alpha+3)(m-1)a_{m-1} - ma_m + (\alpha+1)^2 a_{m-1} - \alpha a_m] x^m = 0.$$

Since $a_0 = 1$ by hypothesis, we must have $\alpha = 0$. As in parts (c) and (d), we end up with a divergent series for $z = y$.

Section A.5

1. Using the formula for the inverse of a 2 by 2 matrix,

$$\Theta^{-1} = \begin{pmatrix} 1 - 2t & -4t \\ t & 1 + 2t \end{pmatrix}.$$

3. Using the formula for the inverse of a 2 by 2 matrix,

$$\Psi^{-1} = \begin{pmatrix} (1+t)e^{2t} & -te^{2t} \\ -e^{2t} & e^{2t} \end{pmatrix}.$$

5. Using row reduction,

$$\begin{aligned} [\mathbf{A}|\mathbf{I}] &= \left(\begin{array}{ccc|ccc} 0 & 1 & -1 & 1 & 0 & 0 \\ 1 & 1 & 0 & 0 & 1 & 0 \\ -1 & 0 & 1 & 0 & 0 & 1 \end{array} \right) \cong \left(\begin{array}{ccc|ccc} 1 & 0 & 1 & -1 & 1 & 0 \\ 0 & 1 & -1 & 1 & 0 & 0 \\ 0 & 0 & 1 & -\frac{1}{2} & \frac{1}{2} & \frac{1}{2} \end{array} \right) \\ &\cong \left(\begin{array}{ccc|ccc} 1 & 0 & 0 & -\frac{1}{2} & \frac{1}{2} & -\frac{1}{2} \\ 0 & 1 & 0 & \frac{1}{2} & \frac{1}{2} & \frac{1}{2} \\ 0 & 0 & 1 & -\frac{1}{2} & \frac{1}{2} & \frac{1}{2} \end{array} \right) = [\mathbf{I}|\mathbf{A}^{-1}]. \end{aligned}$$

7. Using row reduction,

$$\begin{aligned} [\mathbf{A}|\mathbf{I}] &= \left(\begin{array}{ccc|ccc} -3 & 1 & -1 & 1 & 0 & 0 \\ -2 & 0 & -1 & 0 & 1 & 0 \\ -1 & 1 & -2 & 0 & 0 & 1 \end{array} \right) \cong \left(\begin{array}{ccc|ccc} 1 & -\frac{1}{3} & \frac{1}{3} & -\frac{1}{3} & 0 & 0 \\ 0 & 1 & \frac{1}{2} & 1 & -\frac{3}{2} & 0 \\ 0 & 0 & -3 & -\frac{3}{2} & \frac{3}{2} & \frac{3}{2} \end{array} \right) \\ &\cong \left(\begin{array}{ccc|ccc} 1 & 0 & 0 & -\frac{1}{4} & -\frac{1}{4} & \frac{1}{4} \\ 0 & 1 & 0 & \frac{3}{4} & -\frac{5}{4} & \frac{1}{4} \\ 0 & 0 & 1 & \frac{1}{2} & -\frac{1}{2} & -\frac{1}{2} \end{array} \right) = [\mathbf{I}|\mathbf{A}^{-1}]. \end{aligned}$$

9. (a)

$$\Theta = \sum_{n=0}^{\infty} \frac{t^n}{n!} \mathbf{A}^n = \sum_{n=0}^{\infty} \frac{t^n}{n!} \begin{pmatrix} 2^n & n2^{n-1} \\ 0 & 2^n \end{pmatrix} = \sum_{n=0}^{\infty} \begin{pmatrix} \frac{(2t)^n}{n!} & \frac{2^{n-1}t^n}{(n-1)!} \\ 0 & \frac{(2t)^n}{n!} \end{pmatrix} = \begin{pmatrix} e^{2t} & te^{2t} \\ 0 & e^{2t} \end{pmatrix},$$

where the last equality follows from

$$\sum_{n=0}^{\infty} \frac{2^{n-1}t^n}{(n-1)!} = t \sum_{m=1}^{\infty} \frac{(2t)^m}{m!} = t \sum_{m=0}^{\infty} \frac{(2t)^m}{m!} = te^{2t}.$$

- (b) The matrix has a double eigenvalue $\lambda = 2$ with eigenvector $\mathbf{v} = \begin{pmatrix} 1 \\ 0 \end{pmatrix}$ and generalized eigenvector $\mathbf{w} = \begin{pmatrix} 0 \\ 1 \end{pmatrix}$. The solutions are then $e^{2t}\mathbf{v}$ and $e^{2t}(t\mathbf{v} + \mathbf{w})$. Hence,

$$\Psi(t) = \begin{pmatrix} e^{2t} & te^{2t} \\ 0 & e^{2t} \end{pmatrix}, \quad \Psi^{-1} = \begin{pmatrix} e^{2t} & -te^{2t} \\ 0 & e^{2t} \end{pmatrix}, \quad \Theta = \Psi(t)\Psi^{-1}(0) = \begin{pmatrix} e^{2t} & te^{2t} \\ 0 & e^{2t} \end{pmatrix}.$$

11. (a) $\mathbf{A}^2 = -\mathbf{I}$, from which follows $\mathbf{A}^3 = -\mathbf{A}$, $\mathbf{A}^4 = \mathbf{I}$, ... Thus,

$$\begin{aligned} \Theta &= \mathbf{I} + t\mathbf{A} - \frac{t^2}{2}\mathbf{I} - \frac{t^3}{6}\mathbf{A} + \frac{t^4}{4!}\mathbf{I} + \dots = \left(1 - \frac{t^2}{2} + \frac{t^4}{4!} - \dots\right)\mathbf{I} + \left(t - \frac{t^3}{6} + \frac{t^5}{5} - \dots\right)\mathbf{A} \\ &= (\cos t)\mathbf{I} + (\sin t)\mathbf{A} = \begin{pmatrix} \cos t - 2\sin t & \sin t \\ -5\sin t & \cos t + 2\sin t \end{pmatrix}. \end{aligned}$$

- (b) The eigenvalues are $\lambda = \pm i$, and the corresponding solutions are $\begin{pmatrix} \cos t \\ 2\cos t - \sin t \end{pmatrix}$ and $\begin{pmatrix} \sin t \\ \cos t + 2\sin t \end{pmatrix}$. Thus,

$$\begin{aligned} \Psi(t) &= \begin{pmatrix} \cos t & \sin t \\ 2\cos t - \sin t & \cos t + 2\sin t \end{pmatrix}, \quad \Psi^{-1}(0) = \begin{pmatrix} 1 & 0 \\ 2 & 1 \end{pmatrix}^{-1} = \begin{pmatrix} 1 & 0 \\ -2 & 1 \end{pmatrix}, \\ \Theta &= \begin{pmatrix} \cos t - 2\sin t & \sin t \\ -5\sin t & \cos t + 2\sin t \end{pmatrix}. \end{aligned}$$

Section A.6

1. The eigenvalues are $\lambda = 1, 3$ and associated eigenvectors are $\begin{pmatrix} 1 \\ -1 \end{pmatrix}$ and $\begin{pmatrix} 0 \\ 1 \end{pmatrix}$.

- (a) The form of solution for undetermined coefficients is

$$\mathbf{x} = \mathbf{a} + \left[\mathbf{b} + c \begin{pmatrix} 0 \\ 1 \end{pmatrix} t \right] e^{3t}.$$

(Note the additional term needed because 3 is an eigenvalue of \mathbf{A} .) After some linear algebra computation, we obtain

$$\mathbf{a} = \begin{pmatrix} -3 \\ 2 \end{pmatrix}, \quad \mathbf{b} = \begin{pmatrix} 0 \\ 0 \end{pmatrix}, \quad c = 1.$$

- (b) We have

$$\Psi = \begin{pmatrix} e^t & 0 \\ -e^t & e^{3t} \end{pmatrix}$$

and

$$[\Psi|g] = \left(\begin{array}{cc|c} e^t & 0 & 3 \\ -e^t & e^{3t} & e^{3t} \end{array} \right) \cong \left(\begin{array}{cc|c} 1 & 0 & 3e^{-t} \\ 0 & e^{3t} & 3 + e^{3t} \end{array} \right) \cong \left(\begin{array}{cc|c} 1 & 0 & 3e^{-t} \\ 0 & 1 & 1 + 3e^{-3t} \end{array} \right) = [\mathbf{I}|\mathbf{u}'].$$

Thus, $u_1 = -3e^{-t}$, $u_2 = t - e^{-3t}$, and the solution is

$$\mathbf{x} = \Psi\mathbf{u} = \begin{pmatrix} -3 \\ 2 + te^{3t} \end{pmatrix}.$$

(c)

$$\mathbf{T} = \begin{pmatrix} 1 & 0 \\ -1 & 1 \end{pmatrix}, \quad \mathbf{D} = \begin{pmatrix} 1 & 0 \\ 0 & 3 \end{pmatrix}, \quad \mathbf{T}^{-1}\mathbf{g} = \begin{pmatrix} 3 \\ 3 + e^{3t} \end{pmatrix},$$

and $\mathbf{x} = \mathbf{T}\mathbf{y}$ yields the problems $y_1' = y_1 + 3$ and $y_2' = 3y_2 + 3 + e^{3t}$. From the particular solutions $y_1 = -3$ and $y_2 = -1 + te^{3t}$, we obtain

$$\mathbf{x} = \mathbf{T}\mathbf{y} = \begin{pmatrix} -3 \\ 2 + te^{3t} \end{pmatrix}.$$

3. The eigenvalues are $\lambda = -2, -3$ and associated eigenvectors are $\begin{pmatrix} 2 \\ 1 \end{pmatrix}$ and $\begin{pmatrix} 1 \\ 1 \end{pmatrix}$.

(a) The form of solution for undetermined coefficients is

$$\mathbf{x} = \mathbf{a}e^t + \mathbf{b}e^{3t}.$$

After some linear algebra computation, we obtain

$$\mathbf{a} = \frac{1}{12} \begin{pmatrix} 5 \\ 1 \end{pmatrix}, \quad \mathbf{b} = \frac{1}{15} \begin{pmatrix} -1 \\ 2 \end{pmatrix}.$$

(b) We have

$$\Psi = \begin{pmatrix} 2e^{-2t} & e^{-3t} \\ e^{-2t} & e^{-3t} \end{pmatrix}$$

and

$$\left(\begin{array}{cc|c} 2e^{-2t} & e^{-3t} & e^t \\ e^{-2t} & e^{-3t} & e^{3t} \end{array} \right) \cong \left(\begin{array}{cc|c} e^{-2t} & 0 & e^t - e^{3t} \\ e^{-2t} & e^{-3t} & e^{3t} \end{array} \right) \cong \left(\begin{array}{cc|c} 1 & 0 & e^{3t} - e^{5t} \\ 0 & 1 & 2e^{6t} - e^{4t} \end{array} \right) = [\mathbf{I}|\mathbf{u}'].$$

Thus, $u_1 = \frac{1}{3}e^{3t} - \frac{1}{5}e^{5t}$, $u_2 = \frac{1}{3}e^{6t} - \frac{1}{4}e^{4t}$, and the solution is

$$\mathbf{x} = \Psi\mathbf{u} = \begin{pmatrix} \frac{5}{12}e^t - \frac{1}{15}e^{3t} \\ \frac{1}{12}e^t + \frac{2}{15}e^{3t} \end{pmatrix}.$$

(c)

$$\mathbf{T} = \begin{pmatrix} 2 & 1 \\ 1 & 1 \end{pmatrix}, \quad \mathbf{D} = \begin{pmatrix} -2 & 0 \\ 0 & -3 \end{pmatrix}, \quad \mathbf{T}^{-1}\mathbf{g} = \begin{pmatrix} e^t - e^{3t} \\ -e^t + 2e^{3t} \end{pmatrix},$$

and $\mathbf{x} = \mathbf{T}\mathbf{y}$ yields the problems $y_1' = -2y_1 + e^t - e^{3t}$ and $y_2' = -3y_2 - e^t + 2e^{3t}$. From the particular solutions $y_1 = \frac{1}{3}e^t - \frac{1}{5}e^{3t}$ and $y_2 = -\frac{1}{4}e^t + \frac{1}{3}e^{3t}$, we obtain

$$\mathbf{x} = \mathbf{T}\mathbf{y} = \begin{pmatrix} \frac{5}{12}e^t - \frac{1}{15}e^{3t} \\ \frac{1}{12}e^t + \frac{2}{15}e^{3t} \end{pmatrix}.$$

5. The eigenvalue is $\lambda = 1$ and an associated eigenvector is $\mathbf{v} = \begin{pmatrix} 0 \\ 1 \end{pmatrix}$. A second solution is

$$(\mathbf{w} + \mathbf{v}t)e^t, \text{ where } \mathbf{w} = \frac{1}{2} \begin{pmatrix} 1 \\ 0 \end{pmatrix}.$$

(a) The form of solution for undetermined coefficients is

$$\mathbf{x} = \mathbf{a} + \mathbf{b}t.$$

After some linear algebra computation, we obtain

$$\mathbf{a} = \begin{pmatrix} -1 \\ 1 \end{pmatrix}, \quad \mathbf{b} = \begin{pmatrix} -1 \\ 2 \end{pmatrix}.$$

(b) We have

$$\mathbf{\Psi} = \begin{pmatrix} 0 & \frac{1}{2}e^t \\ e^t & te^t \end{pmatrix}$$

and

$$[\mathbf{\Psi}|g] = \left(\begin{array}{cc|c} 0 & \frac{1}{2}e^t & t \\ e^t & te^t & 3 \end{array} \right) \cong \left(\begin{array}{cc|c} 1 & t & 3e^{-t} \\ 0 & 1 & 2te^{-t} \end{array} \right) \cong \left(\begin{array}{cc|c} 1 & 0 & (3-2t^2)e^{-t} \\ 0 & 1 & 2te^{-t} \end{array} \right) = [\mathbf{I}|\mathbf{u}'].$$

Thus, $u_1 = (1 + 4t + 2t^2)e^{-t}$, $u_2 = (-2 - 2t)e^{-t}$, and the solution is

$$\mathbf{x} = \mathbf{\Psi}\mathbf{u} = \begin{pmatrix} -1 - t \\ 1 + 2t \end{pmatrix}.$$

(c) Diagonalization cannot be done because the matrix is deficient.

7. The eigenvalues are $\lambda = 1, 2$ and associated eigenvectors are $\mathbf{v}^{(1)} = \begin{pmatrix} 1 \\ -1 \\ 1 \end{pmatrix}$ and $\mathbf{v}^{(2)} = \begin{pmatrix} 1 \\ 0 \\ 0 \end{pmatrix}$. A second solution for $\lambda = 1$ is $(\mathbf{w} + \mathbf{v}t)e^t$, where $\mathbf{w} = \begin{pmatrix} 0 \\ 0 \\ -1 \end{pmatrix}$.

(a) The form of solution for undetermined coefficients is

$$\mathbf{x} = \left(\mathbf{a} + c\mathbf{v}^{(2)}t \right) e^{2t},$$

where the extra term is necessary because 2 is an eigenvalue of \mathbf{A} . After some linear algebra computation, we obtain

$$\mathbf{a} = \begin{pmatrix} \alpha \\ 2 \\ -1 \end{pmatrix}, \quad c = 1, \quad \alpha \in \mathbb{R}.$$

(b) We have

$$\mathbf{\Psi} = \begin{pmatrix} e^t & te^t & e^{2t} \\ -e^t & -te^t & 0 \\ e^t & (t-1)e^t & 0 \end{pmatrix}$$

and

$$[\mathbf{\Psi}|g] \cong \left(\begin{array}{ccc|c} 1 & t & 0 & -e^t \\ 0 & -e^t & 0 & e^{2t} \\ 0 & 0 & e^{2t} & e^{2t} \end{array} \right) \cong \left(\begin{array}{ccc|c} 1 & 0 & 0 & (t-1)e^t \\ 0 & 1 & 0 & -e^t \\ 0 & 0 & 1 & 1 \end{array} \right) = [\mathbf{I}|\mathbf{u}'].$$

Thus, $u_1 = (t-2)e^t$, $u_2 = -e^t$, $u_3 = t$, and the solution is

$$\mathbf{x} = \mathbf{\Psi}\mathbf{u} = \begin{pmatrix} -2 + t \\ 2 \\ -1 \end{pmatrix} e^{2t}.$$

(c) Diagonalization cannot be done because the matrix is deficient.

9. (a) From Exercise 5, we have

$$\Psi = \begin{pmatrix} 0 & \frac{1}{2}e^t \\ e^t & te^t \end{pmatrix}.$$

Thus,

$$[\Psi|g] \cong \left(\begin{array}{cc|c} 1 & t & 0 \\ 0 & 1 & 2e^{-t-t^2} \end{array} \right) \cong \left(\begin{array}{cc|c} 1 & 0 & -2te^{-t-t^2} \\ 0 & 1 & 2e^{-t-t^2} \end{array} \right) = [\mathbf{I}|u'].$$

Thus, $u_1 = -2 \int_0^t se^{-s-s^2} ds$, $u_2 = 2 \int_0^t e^{-s-s^2} ds$, and the solution is

$$\mathbf{x} = \Psi \mathbf{u} = \begin{pmatrix} \frac{1}{2}e^t u_2 \\ e^t(u_1 + tu_2) \end{pmatrix} = \begin{pmatrix} e^t \int_0^t e^{-s-s^2} ds \\ 2e^t \int_0^t (t-s)e^{-s-s^2} ds \end{pmatrix}.$$

(b) The method of undetermined coefficients cannot be used because \mathbf{g} is not a generalized exponential function, while the method of diagonalization cannot be used because the matrix \mathbf{A} is deficient.

11. (a) The eigenvalues are $\lambda = \pm 2i$ and the corresponding eigenvectors are $\begin{pmatrix} 1 \\ -2i \end{pmatrix}$ and $\begin{pmatrix} 1 \\ 2i \end{pmatrix}$.

(b)

$$T = \begin{pmatrix} 1 & 1 \\ -2i & 2i \end{pmatrix}, \quad D = \begin{pmatrix} 2i & 0 \\ 0 & -2i \end{pmatrix}, \quad \mathbf{T}^{-1}\mathbf{g} = \begin{pmatrix} 2+2i \\ 2-2i \end{pmatrix} e^{2t},$$

and $\mathbf{x} = \mathbf{T}\mathbf{y}$ yields the problems $y_1' = 2iy_1 + (2+2i)e^{2t}$ and $y_2' = -2iy_2 + (2-2i)e^{2t}$. From the particular solutions $y_1 = ie^{2t}$ and $y_2 = -ie^{2t}$, we obtain the particular solution

$$\mathbf{x} = \mathbf{T}\mathbf{y} = \begin{pmatrix} 0 \\ 4 \end{pmatrix} e^{2t}.$$

Combining this with the complementary solution yields the result

$$\mathbf{x} = \begin{pmatrix} 0 \\ 4 \end{pmatrix} e^{2t} + \begin{pmatrix} \cos 2t & \sin 2t \\ 2 \sin 2t & -2 \cos 2t \end{pmatrix} \mathbf{c}.$$

(c) The form of solution for undetermined coefficients is

$$\mathbf{x} = \mathbf{b}e^{2t}.$$

We find

$$\mathbf{b} = \begin{pmatrix} 0 \\ 4 \end{pmatrix};$$

thus, the general solution is

$$\mathbf{x} = \begin{pmatrix} 0 \\ 4 \end{pmatrix} e^{2t} + \begin{pmatrix} \cos 2t & \sin 2t \\ 2 \sin 2t & -2 \cos 2t \end{pmatrix} \mathbf{c}.$$

Chapter A: Some Additional Topics

13. (a) Let $z = \ln t$, as for Cauchy-Euler equations. Then $\frac{d}{dt} = \frac{1}{t} \frac{d}{dz}$, so the differential equation becomes

$$\frac{d\mathbf{x}}{dz} = \mathbf{B}\mathbf{x} + \mathbf{g}(e^z).$$

- (b) The problem is

$$\frac{d\mathbf{x}}{dz} = \begin{pmatrix} 1 & 3 \\ 1 & -1 \end{pmatrix} \mathbf{x} + \begin{pmatrix} 0 \\ 5 \end{pmatrix} e^{3z}.$$

The eigenvalues are $\lambda = 2, -2$ and corresponding eigenvectors are $\begin{pmatrix} 3 \\ 1 \end{pmatrix}$ and $\begin{pmatrix} 1 \\ -1 \end{pmatrix}$. A particular solution has the form $\mathbf{x} = \mathbf{a}e^{3z}$; substitution of this form into the differential equation yields $\mathbf{a} = \begin{pmatrix} 3 \\ 2 \end{pmatrix}$. Hence, we have the general solution

$$\mathbf{x} = \begin{pmatrix} 3 \\ 2 \end{pmatrix} e^{3z} + c_1 \begin{pmatrix} 3 \\ 1 \end{pmatrix} e^{2z} + c_2 \begin{pmatrix} 1 \\ -1 \end{pmatrix} e^{-2z} = \begin{pmatrix} 3t^3 + 3c_1t^2 + c_2t^{-2} \\ 2t^3 + c_1t^2 - c_2t^{-2} \end{pmatrix}.$$

15. (a) The eigenvalue is $\lambda = 1$ and an associated eigenvector is $\mathbf{v} = \begin{pmatrix} 1 \\ 1 \end{pmatrix}$. A second solution is $(\mathbf{w} + \mathbf{v}t)e^t$, where $\mathbf{w} = \frac{1}{2} \begin{pmatrix} 1 \\ 0 \end{pmatrix}$. We therefore have

$$\mathbf{\Psi} = \begin{pmatrix} e^t & (\frac{1}{2} + t)e^t \\ e^t & te^t \end{pmatrix}$$

and

$$[\mathbf{\Psi}|g] \cong \left(\begin{array}{cc|c} 1 & \frac{1}{2} + t & 1 \\ 1 & t & -1 \end{array} \right) \cong \left(\begin{array}{cc|c} 1 & t & -1 \\ 0 & \frac{1}{2} & 2 \end{array} \right) \cong \left(\begin{array}{cc|c} 1 & 0 & -1 - 4t \\ 0 & 1 & 4 \end{array} \right) = [\mathbf{I}|\mathbf{u}'].$$

Thus, $u_1 = -t - 2t^2$, $u_2 = 4t$, and the solution is

$$\mathbf{x} = \mathbf{\Psi}\mathbf{u} = \begin{pmatrix} t + 2t^2 \\ -t + 2t^2 \end{pmatrix} e^t.$$

- (b) Using part (a) as a model, we expect a particular solution of the form

$$\mathbf{x} = (\mathbf{b} + \mathbf{d}t + k\mathbf{v}t^2) e^{at},$$

where \mathbf{b} and \mathbf{d} are undetermined constant vectors, \mathbf{v} is an eigenvector, and k is an undetermined scalar. Substituting this form into the equation $\mathbf{x}' = \mathbf{A}\mathbf{x} + \mathbf{w}e^{at}$ and using the identity $\mathbf{A}\mathbf{v} = a\mathbf{v}$ ultimately yields the algebraic system

$$(\mathbf{A} - a\mathbf{I})\mathbf{d} = 2k\mathbf{v}, \quad (\mathbf{A} - a\mathbf{I})\mathbf{b} = \mathbf{d} - \mathbf{w}.$$

The matrix $\mathbf{A} - a\mathbf{I}$ is singular, so the first equation requires that \mathbf{d} be any generalized eigenvector. The second equation also has solutions, but only if the generalized eigenvector \mathbf{d} is chosen carefully.

(c) We have eigenvalue $a = 2$ and

$$\mathbf{A} - a\mathbf{I} = \begin{pmatrix} -2 & 1 \\ -4 & 2 \end{pmatrix}, \quad \mathbf{v} = \begin{pmatrix} 1 \\ 2 \end{pmatrix}.$$

The equation $(\mathbf{A} - a\mathbf{I})\mathbf{d} = 2k\mathbf{v}$ is consistent for any k and has solutions that satisfy $-2d_1 + d_2 = 2k$. The equation $(\mathbf{A} - a\mathbf{I})\mathbf{b} = \mathbf{d} - \mathbf{w}$ is consistent only if $d_2 = 2d_1 - 2$, and this requirement together with the other yields $k = -1$. Once a suitable vector \mathbf{d} is chosen, \mathbf{b} must satisfy $-2b_1 + b_2 = d_1 - 1 = \frac{1}{2}d_2$. The simplest solution is obtained by choosing $d_1 = 1$ and $b_1 = b_2 = d_2 = 0$. This yields the solutions

$$\mathbf{x}_p = \begin{pmatrix} t - t^2 \\ -2t^2 \end{pmatrix} e^{-2t}, \quad \mathbf{x} = d_1 \begin{pmatrix} 1 \\ 2 \end{pmatrix} e^{-2t} + d_2 \begin{pmatrix} 1 + t \\ 2t \end{pmatrix} e^{-2t} + \begin{pmatrix} t - t^2 \\ -2t^2 \end{pmatrix} e^{-2t}.$$

Note that we have used \mathbf{d} as the generalized eigenvector needed for $\mathbf{x}^{(2)}$.

Section A.7

1. Substituting $u_n = b_n g_n(t) \sin n\pi x$ into the differential equation gives us $g'_n = -n^2 \pi^2 k g_n$. Thus,

$$u(x, t) = \sum_{n=1}^{\infty} b_n e^{-n^2 \pi^2 k t} \sin n\pi x, \quad b_n = \int_0^1 f(x) \sin n\pi x dx.$$

3. (a) Using the general solution from Exercise A.7.1,

$$u(x, t) = \sum_{n=1}^{\infty} b_{n,h} e^{-n^2 \pi^2 t} \sin n\pi x$$

where

$$b_{n,h} = \frac{1}{2h} \int_{1/2-h}^{1/2+h} \sin n\pi x dx = \frac{[\cos(\frac{n\pi}{2} - hn\pi) - \cos(\frac{n\pi}{2} + hn\pi)]}{2hn\pi}.$$

The identity $\cos \alpha - \cos \beta = -2 \sin \frac{\alpha+\beta}{2} \sin \frac{\alpha-\beta}{2}$ reduces the coefficient formula to

$$b_{n,h} = \sin \frac{n\pi}{2} \frac{\sin hn\pi}{hn\pi}, \quad \sin \frac{n\pi}{2} = \begin{cases} -1 & n = 3, 7, 11, \dots \\ 0 & n = 2, 4, 6, 8, \dots \\ 1 & n = 1, 5, 9, \dots \end{cases}$$

(b)

$$u = \lim_{h \rightarrow 0} \sum_{n=1}^{\infty} b_{n,h} e^{-n^2 \pi^2 t} \sin n\pi x = \sum_{n=1}^{\infty} \sin \frac{n\pi}{2} e^{-n^2 \pi^2 t} \sin n\pi x.$$

(c) We use the same idea with $f = \delta(x - 1/2)$. Thus

$$b_n = \int_0^1 \delta(x - 1/2) \sin n\pi x dx = \sin \frac{n\pi}{2},$$

which is the same as the solution of part (b).

(d) We have

$$u(0.5, t) = \sum_{n=1}^{\infty} \frac{\sin hn\pi}{hn\pi} \frac{1 + (-1)^n}{2} e^{-n^2\pi^2 t}.$$

In particular, at $t = 0$, the exponential factor does not contribute to the convergence of the series. The series for $u(0.5, 0)$ does not even converge for $h = 0$, and the convergence is very slow for h small. See Figure 100.

(e) The small h calculation of parts (a) and (b) requires less specialized knowledge and study; however, the $h = 0$ calculation of part (c) is elementary once one has understood how to deal with generalized functions. The $h = 0$ calculation is wrong for extremely small times; however, the h small calculation is not very useful for small times anyway. On the whole, mathematicians and engineers prefer the use of delta functions over more detailed initial condition models such as that of part (a).

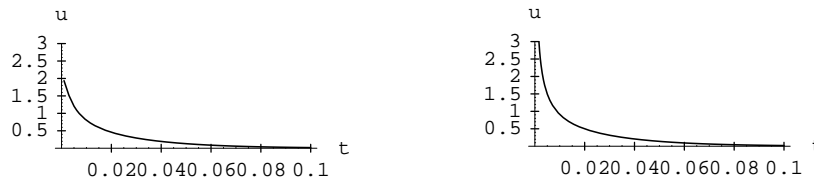

Figure 100: Exercise A.7.3

5. The original problem is

$$T_t = kT_{xx}, \quad T(0, t) = 100, \quad T(1, t) = 20, \quad T(x, 0) = 20.$$

The steady state problem consists of the equations $T_s'' = 0$, $T_s(0) = 100$, and $T_s(1) = 20$; hence, $T_s(x) = -80x + 100$. If we let $w = T - T_s$, the problem becomes

$$w_t = kw_{xx}, \quad w(0, t) = 0, \quad w(1, t) = 0, \quad w(x, 0) = 80x - 80, \quad T = 100 - 80x + w.$$

Let $u = w/80$ and $\tau = kt$. Now the problem is

$$u_\tau = u_{xx}, \quad u(0, \tau) = 0, \quad u(1, \tau) = 0, \quad u(x, 0) = x - 1, \quad T = 100 - 80x + 80u.$$

The solution of this problem is

$$u(x, \tau) = \sum_{n=1}^{\infty} b_n e^{-n^2\pi^2\tau} \sin n\pi x, \quad b_n = 2 \int_0^1 (x - 1) \sin n\pi x \, dx = -\frac{2}{n\pi}.$$

In terms of the original variable T ,

$$T = 100 - 80x - \sum_{n=1}^{\infty} \frac{160}{n\pi} e^{-n^2\pi^2 kt} \sin n\pi x.$$

See Figure 101.

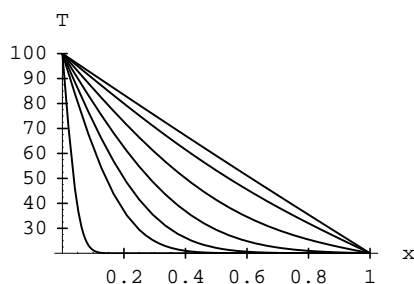

Figure 101: Exercise A.7.5

7. Let $u = f(x)g(t)$. Then f satisfies $f'' - \lambda f = 0$, $f'(0) = 0$, $f'(1) = 0$ and g satisfies $g' - \lambda g = 0$. If $\lambda > 0$, there are no solutions to the eigenvalue problem. If $\lambda = 0$, then $f = 1$ is a solution. If $\lambda < 0$, let $\lambda = -k^2$. Then the solutions to the eigenvalue problem are $f = \cos k\pi x$ for $k = 1, 2, 3, \dots$. The solution of the differential equation for g when $\lambda = 0$ is $g = c$ for some constant c . The solutions for $\lambda = -k^2 < 0$ are $g = \exp(-n^2\pi^2 t)$. We therefore have a series solution

$$u(x, t) = a_0 + \sum_{n=1}^{\infty} a_n e^{-n^2\pi^2 t} \cos n\pi x.$$

The coefficients must be chosen to satisfy

$$\phi(x) = a_0 + \sum_{n=1}^{\infty} a_n \cos n\pi x.$$

Since the eigenfunctions are orthogonal, we can multiply by $\cos m\pi x$ and integrate over $[0, 1]$ to get

$$a_0 = \bar{\phi}, \quad a_n = 2 \int_0^1 \phi(x) \cos n\pi x \, dx,$$

where $\bar{\phi}$ is the average of the function ϕ .

9. (a) Substituting $u = f(x)g(t)$ into the differential equation and putting all of functions of x on one side gives us $f'' - \sigma f = 0$, $f(0) = 0$ and $f'(1) = -f(1)$. The equation g must satisfy is $g' - \sigma g = 0$.
- (b) The constant σ must be negative, so let $\sigma = -\lambda^2$. Then we have

$$f_n = \sin \lambda_n x, \quad \lambda_n \cos \lambda_n = -\sin \lambda_n;$$

hence, the eigenvalues are the solutions of $\lambda + \tan \lambda = 0$.

- (c) The solution of the differential equation for g is $g_n = e^{-\lambda_n^2 t}$. Thus, the solution of the homogeneous part of the problem is

$$u = b_n \sum_{n=1}^{\infty} e^{-\lambda_n^2 t} \sin \lambda_n x.$$

- (d)

$$\int_0^1 \sin^2 \lambda_n x \, dx = \int_0^1 \frac{1 - \cos 2\lambda_n x}{2} \, dx = \frac{1}{2} - \frac{\sin 2\lambda_n}{4\lambda_n} = \frac{1}{2} - \frac{\sin \lambda_n \cos \lambda_n}{2\lambda_n}.$$

Since $\tan \lambda_n = -\lambda_n$, this integral is equal to $(1 + \cos^2 \lambda_n)/2$.

(e) The coefficients must satisfy

$$u(x, 0) = \phi(x) = \sum_{n=1}^{\infty} b_n \sin \lambda_n x.$$

Eigenfunctions are automatically orthogonal, so multiplying by $\sin \lambda_m x$ and integrating yields

$$\int_0^1 \phi(x) \sin \lambda_m x \, dx = b_m \int_0^1 \sin^2 \lambda_m x \, dx = \frac{1 + \cos^2 \lambda_m}{2} b_m.$$

Thus,

$$b_n = \frac{2}{1 + \cos^2 \lambda_n} \int_0^1 \phi(x) \sin^2 \lambda_n \, dx.$$

11. ⁴ Letting $u(t, \theta) = f(\theta)g(t)$ and substituting this into the differential equation gives us

$$g' - \sigma g = 0, \quad f'' - \sigma f = 0, \quad f(\pi) = f(-\pi), \quad f'(\pi) = f'(-\pi).$$

If $\sigma > 0$, there are no solutions to the eigenvalue problem. If $\sigma = 0$, then $f = g = 1$ is a solution to the eigenvalue problem. If $\sigma = -\lambda^2 < 0$, then $f = A \cos \lambda \theta + B \sin \lambda \theta$. The boundary conditions are satisfied for $\lambda_n = n\pi$. The solution for the g equation is $g_n = e^{-k^2 t}$. Thus the solution of the original problem can be written in the form

$$u = a_0 + \sum_{n=1}^{\infty} e^{-n^2 t} (a_n \cos n\theta + b_n \sin n\theta).$$

From Section 8.5, Equations (5) and (6), we have

$$a_0 = \bar{f} = \frac{1}{2\pi} \int_{-\pi}^{\pi} \phi(\theta) \, d\theta, \quad a_n = \frac{1}{\pi} \int_{-\pi}^{\pi} \phi(\theta) \cos n\theta \, d\theta, \quad b_n = \int_{-\pi}^{\pi} \phi(\theta) \sin n\theta \, d\theta.$$

Section A.8

1. (a) We break this into two subproblems. The first is

$$\begin{aligned} u_{xx} + u_{yy} &= 0, & 0 < x, y < 1 \\ u(x, 0) &= 0, & u(x, 1) &= 0, & u(0, y) &= 0, & u(1, y) &= y \end{aligned}$$

The substitution $u = f(y)g(x)$ leads to the eigenvalue problem

$$f'' + kf = 0, \quad f(0) = f(1) = 0, \quad g'' - kg = 0, \quad g(0) = 0.$$

The solutions are $f_n = \sin n\pi y$ and $g_n = \sinh n\pi x$, and the full series solution is

$$u = \sum_{n=1}^{\infty} b_n \sinh n\pi x \sin n\pi y.$$

The remaining condition is

$$y = \sum_{n=1}^{\infty} b_n \sinh n\pi \sin n\pi y,$$

⁴Exercise A.7.11 contains typographical errors in the first printing. The spatial domain should be $-\pi < 0 \leq \pi$ and the initial condition should be $u(\theta, 0) = \phi(\theta)$.

from which we obtain $b_n \sinh n\pi = 2 \int_0^1 y \sin n\pi y \, dy = -2(-1)^n/(n\pi)$. Thus, the solution of this problem is

$$u_1 = \frac{2}{\pi} \sum_{n=1}^{\infty} \frac{(-1)^{n+1}}{n \sinh n\pi} \sinh n\pi x \sin n\pi y.$$

The second problem is

$$\begin{aligned} u_{xx} + u_{yy} &= 0, & 0 < x, y < 1 \\ u(x, 0) &= 0, & u(x, 1) = x, & u(0, y) = 0, & u(1, y) = 0 \end{aligned}$$

This problem can be obtained from the first problem by interchanging x and y ; hence, its solution is $u_1(y, x)$. The solution of the full problem is

$$u = \frac{2}{\pi} \sum_{n=1}^{\infty} \frac{(-1)^{n+1}}{n \sinh n\pi} (\sinh n\pi x \sin n\pi y + \sinh n\pi y \sin n\pi x).$$

- (b) See Figure 102. The solution seems to oscillate if you do not use enough terms and the solution seems to become zero in a region near $(1, 1)$. These problems occur because the boundary conditions for the two subproblems are not continuous at $(1, 1)$.
- (c) See Figure 102.

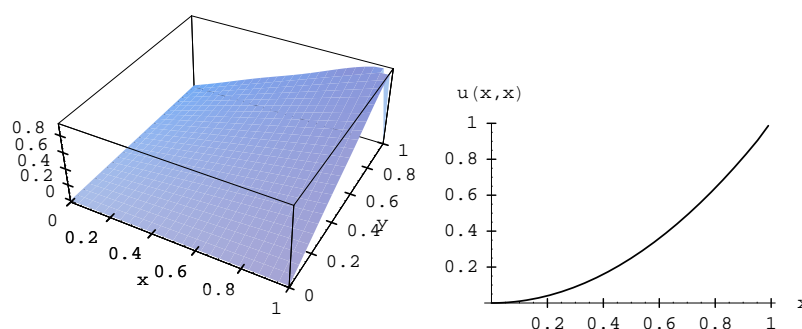

Figure 102: Exercise A.8.1

3. The solution of the homogeneous part of the problem is given by Equation (12) in the text as

$$u = \sin \bar{\theta} + \sum_{n=1}^{\infty} r^n (a_n \cos n\theta + b_n \sin n\theta).$$

The remaining boundary condition is

$$\sin \theta = \sin \bar{\theta} + \sum_{n=1}^{\infty} (a_n \cos n\theta + b_n \sin n\theta),$$

which immediately yields $b_1 = 1$ and all other coefficients are 0. The solution is

$$u = r \sin \theta = y,$$

which is easily verified by direct substitution.

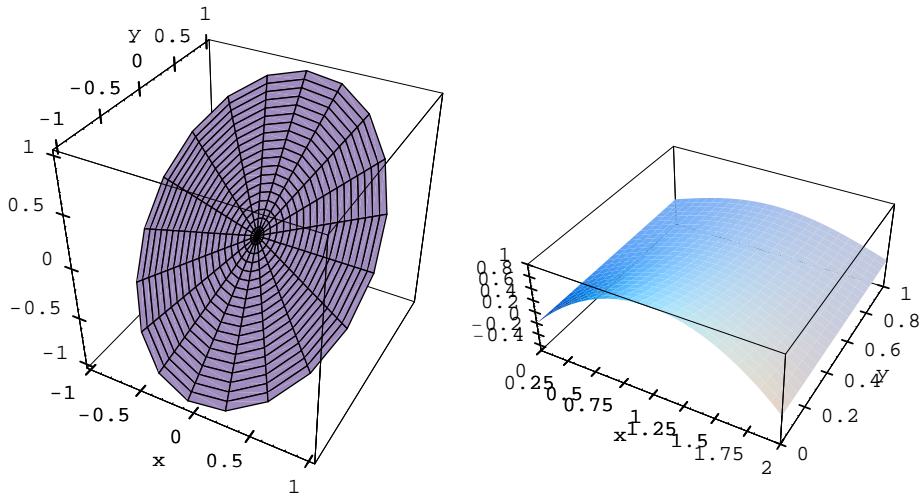

Figure 103: Exercises A.8.3 and A.8.5

5. (a) Let $Y = 1 - y$, $U(x, Y) = u(x, 1 - y)$. Then the problem is

$$U_{xx} + U_{YY} = 0, \quad 0 < x < 2, \quad 0 < y < 1,$$

$$U(x, 1) = 2x - x^2, \quad U_Y(x, 0) = 0, \quad U(0, Y) = 0, \quad U(2, Y) = 0.$$

The eigenvalue problem is

$$f'' + kf = 0, \quad f(0) = f(2) = 0, \quad g'' - kg = 0, \quad g'(0) = 0,$$

and the solutions are $f_n = \sin \frac{1}{2}n\pi x$ and $g_n = \cosh \frac{1}{2}n\pi Y$. We therefore have the series solution

$$U = \sum_{n=1}^{\infty} b_n \cosh \frac{n\pi Y}{2} \sin \frac{n\pi x}{2}.$$

The coefficients must satisfy

$$2x - x^2 = \sum_{n=1}^{\infty} b_n \cosh \frac{n\pi}{2} \sin \frac{n\pi x}{2};$$

hence,

$$b_n \cosh \frac{n\pi}{2} = \int_0^2 (2x - x^2) \sin \frac{n\pi x}{2} dx = \frac{16[1 - (-1)^n]}{n^3\pi^3}.$$

Thus,

$$U = \frac{16}{\pi^3} \sum_{n=1}^{\infty} \frac{[1 - (-1)^n]}{n^3} \frac{\cosh \frac{n\pi Y}{2}}{\cosh \frac{n\pi}{2}} \sin \frac{n\pi x}{2}$$

and

$$u = \frac{16}{\pi^3} \sum_{n=1}^{\infty} \frac{[1 - (-1)^n]}{n^3} \frac{\cosh \frac{n\pi(1-y)}{2}}{\cosh \frac{n\pi}{2}} \sin \frac{n\pi x}{2}.$$

See Figure 103.

(b) Instead we can solve the problem

$$w_{xx} + w_{yy} = 0, \quad 0 < x, y < 2$$

$$w(0, y) = 0, \quad w(2, y) = 0, \quad w(x, 0) = x(2 - x), \quad w(x, 2) = x(2 - x)$$

To solve this we break it into two subproblems. The first is

$$w_{xx} + w_{yy} = 0, \quad 0 < x, y < 2$$

$$w(0, y) = 0, \quad w(2, y) = 0, \quad w(x, 0) = 0, \quad w(x, 2) = x(2 - x),$$

whose solution by Model Problem A.8a is

$$w = \frac{16}{\pi^3} \sum_{n=1}^{\infty} \frac{[1 - (-1)^n]}{n^3} \frac{\sinh \frac{n\pi y}{2}}{\sinh n\pi} \sin \frac{n\pi x}{2}.$$

The second is

$$w_{xx} + w_{yy} = 0, \quad 0 < x, y < 2$$

$$w(0, y) = 0, \quad w(2, y) = 0, \quad w(x, 0) = x(2 - x), \quad w(x, 2) = 0,$$

whose solution, using the symmetry in y , is

$$w = \frac{16}{\pi^3} \sum_{n=1}^{\infty} \frac{[1 - (-1)^n]}{n^3} \frac{\sinh \frac{n\pi(2-y)}{2}}{\sinh n\pi} \sin \frac{n\pi x}{2}.$$

Thus

$$w = \frac{16}{\pi^3} \sum_{n=1}^{\infty} \frac{[1 - (-1)^n]}{n^3} \frac{\sinh \frac{n\pi y}{2} + \sinh \frac{n\pi(2-y)}{2}}{\sinh n\pi} \sin \frac{n\pi x}{2}.$$

Then

$$w_y(x, 1) = \frac{16}{\pi^3} \sum_{n=1}^{\infty} \frac{[1 - (-1)^n]}{n^3} \frac{n\pi}{2} \frac{\cosh(n\pi/2) - \cosh(n\pi/2)}{\sinh n\pi} \sin(n\pi x/2) = 0.$$

(c) Part (a) requires us to solve only one problem. Part (b) has us solve two problems but they are both somewhat easier than the problem in part (a). The work in part (b) is also much more symmetric, so the calculations are easier to follow. The solutions actually are identical. Using the identity $2 \cosh a \sinh b = \sinh(b + a) + \sinh(b - a)$, we have

$$\frac{\cosh \frac{n\pi(1-y)}{2}}{\cosh \frac{n\pi}{2}} = \frac{2 \cosh \frac{n\pi(1-y)}{2} \sinh \frac{n\pi}{2}}{2 \cosh \frac{n\pi}{2} \sinh \frac{n\pi}{2}} = \frac{\sinh \frac{n\pi y}{2} + \sinh \frac{n\pi(2-y)}{2}}{\sinh n\pi} \sin \frac{n\pi x}{2}.$$

11. (a) Letting $u = 1 - r + w(r, \theta)$ means that w satisfies

$$w_{rr} + \frac{1}{r}w_r + \frac{1}{r^2}w_{\theta\theta} = \frac{1}{r}, \quad 0 < r < 1, \quad 0 < \theta < \pi$$

$$w(1, \theta) = 0, \quad w(r, 0) = 0, \quad w(r, \pi) = 0.$$

(b) The substitution $w(r, \theta) = f(\theta)g(r)$ yields the eigenvalue problem $f'' + \lambda f = 0$, $f(0) = 0$, $f(\pi) = 0$. The solutions are $f_n = \sin n\theta$ for $n = 1, 2, 3, \dots$

(c) The given form for w leads to the equation

$$\sum_{n=1}^{\infty} (r^2 g_n'' + r g_n' - n^2 g_n) \sin n\theta = r.$$

(d) The quantity on the left of the equation of part (c) is a Fourier series; hence, it must be the same as the Fourier series for the quantity on the right. Equating coefficients, we have

$$r^2 g_n'' + r g_n' - n^2 g_n = \frac{2}{\pi} \int_0^\pi r \sin n\theta \, d\theta = \frac{2[1 - (-1)^n]}{n\pi}.$$

We also have boundary conditions $g(1) = 0$ and $|g(0)| < \infty$.

(e) The complementary solution of the differential equation is $g_{nc} = c_1 r^n + c_2 r^{-n}$, and the boundedness condition at $r = 0$ then forces $c_2 = 0$. The particular solutions are $2r \ln r / \pi$ for $n = 1$ and $2[1 - (-1)^n]r / [n(n^2 - 1)\pi]$ for $n \geq 2$. With the initial conditions, we obtain the results

$$g_1 = \frac{2}{\pi} r \ln r, \quad g_n = -\frac{2[1 - (-1)^n]}{n(n^2 - 1)\pi} (r - r^n), \quad n \geq 2.$$

Thus, the solution of the original problem is

$$u = 1 - r + \frac{2}{\pi} r \ln r \sin \theta - \frac{2}{\pi} \sum_{n=3}^{\infty} \frac{[1 - (-1)^n]}{n(n^2 - 1)} (r - r^n) \sin n\theta.$$

(Note that the even terms in the sum are all 0; hence, the sum starts at $n = 3$.)

(f) See Figure 104.

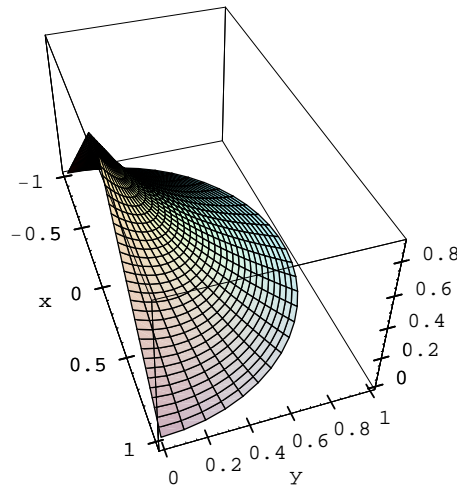

Figure 104: Exercise A.8.11